



**TMH** 



Catalogue

**LIGHTS & BULBS**



-  Most articles stated in this catalogue are available from stock, unless they were sold out after the publication of this catalogue. Contact us if you require a similar article that is not shown in this catalogue: alternatives might be available. TVH is a supplier of spare parts and accessories suitable for OEM-equipment. OEM-references and makes are purely indicative and do not imply that the accessories and/or spare parts originate from the original equipment or parts manufacturer. Please consult our general terms and conditions of sale on [www.tvh.com/avv](http://www.tvh.com/avv).
-   
 De meeste in deze catalogus vermelde artikelen zijn uit voorraad leverbaar, tenzij ze na publicatie van deze catalogus uitverkocht werden. Contacteer ons indien u een gelijkaardig artikel wenst dat niet in deze catalogus is opgenomen: het is mogelijk dat wij ook dit kunnen leveren. TVH is een leverancier van reserveonderdelen en accessoires geschikt voor OEM-uitrusting. OEM-referenties en merken zijn enkel indicatief en betekenen niet dat de accessoires en/of onderdelen afkomstig zijn van de originele toestel- of onderdelenfabrikant. Gelieve onze algemene verkoopsvoorwaarden te consulteren op [www.tvh.com/avv](http://www.tvh.com/avv).
-  La plupart des articles mentionnés dans ce catalogue sont disponibles sauf si épuisement du stock à la publication de ce catalogue. Contactez-nous si vous souhaitez un article similaire qui n'est pas repris dans ce catalogue : il est possible que nous pouvons vous le fournir. TVH est un fournisseur de pièces détachées et d'accessoires adaptables sur des marques constructeurs. Les références et marques constructeurs sont uniquement indicatives et n'impliquent pas que les accessoires et/ou pièces proviennent du fabricant de la machine ou de la pièce d'origine. Veuillez consulter nos conditions générales de vente sur [www.tvh.com/avv](http://www.tvh.com/avv).
-  Die in dieser Liste aufgeführten Artikel sind in der Regel ab Lager lieferbar es sei denn, sie sind nach der Veröffentlichung des vorliegenden Katalogs ausverkauft. Kontaktieren Sie uns wenn Sie einen ähnlichen Artikel benötigen dieser aber nicht im Katalog enthalten ist: Alternativen könnten verfügbar sein. TVH ist Lieferant von Ersatzteilen und Zubehör die für die OEM – Ausstattung geeignet sind. OEM-Referenzen und Marken sind rein Indikativ und bedeuten nicht, dass das Zubehör und/oder Ersatzteile vom Originalgeräte- oder Ersatzteilhersteller sind. Druckfehler vorbehalten. Alle Verkäufe unterliegen den allgemeinen Geschäftsbedingungen [www.tvh.com/avv](http://www.tvh.com/avv).
-  La mayoría de los artículos que figuran en este catálogo se encuentran en stock, a menos que tras la publicación de este catálogo se hayan agotado. Contacte con nosotros si desea un artículo similar que no se halle en este catálogo : es posible que podamos ofrecerle aquel que usted necesita. TVH es un proveedor de recambios y accesorios adecuados para equipos OEM. Las referencias y marcas OEM mencionadas son meramente indicativas y no implican que los accesorios y / o recambios procedan del fabricante de maquinaria o recambios original. Por favor, consulte nuestras condiciones de venta en [www.tvh.com/avv](http://www.tvh.com/avv).
-  La maggior parte dei ricambi elencati in questo catalogo sono a stock, a meno che dopo la pubblicazione di questo catalogo sono stati venduti. Contatateci se desiderate un articolo simile che non è riportato in questo catalogo: è possibile che possiamo offrire anche questi. TVH è un fornitore di pezzi di ricambio e accessori per OEM, riferimenti OEM e marche sono solo indicativi e non implicano che gli accessori e/o di componenti derivino dal costruttore originale o dal produttore del componente. Si prega di consultare i nostri termini di vendita su [www.tvh.com/avv](http://www.tvh.com/avv).
-  Części z tego katalogu są zazwyczaj na stanie magazynowym. Również części które nie są wyszczególnione w katalogu mogą być dostarczone na zamówienie w najkrótszym możliwym terminie. Opis części O.E.M. jest używany informacyjnie i nie wskazuje na to, że dany produkt jest wyprodukowany przez podanego producenta. Zawartość katalogu może ulec zmianie bez wcześniejszego informowania o tym. Wszystkie użyte zdjęcia, rysunki, nazwy marek, opis i numery służą tylko do identyfikacji.
-  Запчасти из настоящего списка, как правило, имеются в запасе, если только он не распродан. Прочие, не фигурирующие в списке артикулы, могут быть поставлены в самые кратчайшие сроки. Указание оригинальных номеров производителя не предполагает обязательного оригинального происхождения самих деталей. Данный список может изменяться без предварительного уведомления. Все использованные фото, рисунки, иллюстрации, названия брендов, наименования и номера служат исключительно для цели идентификации.





passionate people  
clear communication **happy customers**  
**smart solutions** excellent experiences  
**strong ambitions**

Dear customer,

In 1969 Paul Thermote & Paul Vanhalst began servicing and selling agricultural machinery, construction machinery and forklift trucks. Today, TVH is one of the most respected names in the material handling industry. Over the past 48 years we have grown from 2 founders to more than 6000 employees with offices and distribution facilities on every continent.

We are committed to being the worldwide leading supplier of quality parts and accessories for the material handling, industrial and agricultural equipment industry. While we take pride in our quality products, we know that without our customers, we would not exist. We are continually striving to increase our product range and to improve our services in order to be the true one-stop shop for our valued customers.

We are looking forward to working with you.

The Thermote & Vanhalst families



Watch our  
company movie.



# HOW CAN WE SERVE YOU?



**TVH PARTS**

## ALL PARTS, ALL MAKES



Computer-controlled stock management  
> 500 000 m<sup>2</sup> of warehousing



One-stop shop  
> 680 000 stock items



Webshop & online support  
> 30 000 000 known references



Technically-skilled employees  
Assistance in 37 languages  
64 nationalities



52 parts branches worldwide  
Happy customers in over 170 countries  
Same-day shipment, next-day delivery



## QUALITY IS OUR PRIORITY

Is quality also a priority in your business? Rely on TVH as your partner.

In-depth product knowledge and specific testing equipment allows us to continuously improve processes and quality standards.



# TVH

## STRONG BRANDS, GUARANTEED QUALITY

Reliable products and services contribute to the day-to-day success of your company. That's why we choose top quality brands for our maintenance, repair and operation products, just like you do.

In addition to those, our strong housebrands guarantee an excellent range and quality standard for our mechanical and hydraulic attachments, internal transport equipment, battery chargers and accessories.



**TOTALSOURCE**

**ENERGIC Plus**

**cam**  
system  
LIFT TRUCK ATTACHMENTS

**TOTALLIFTER**

**Climax**



## WHAT CAN YOU EXPECT MORE?

Our offer of **reconditioned parts** is unique in the market. Our technicians follow the strictest quality procedures to finalise the reconditioning. After extensive testing, the parts are then placed in stock.

We also repair **electronic parts** in our high-tech electronic department. Our range includes printed circuit boards, electronic speed controllers, displays, chargers, contactors, joysticks, accelerators and directional switches.

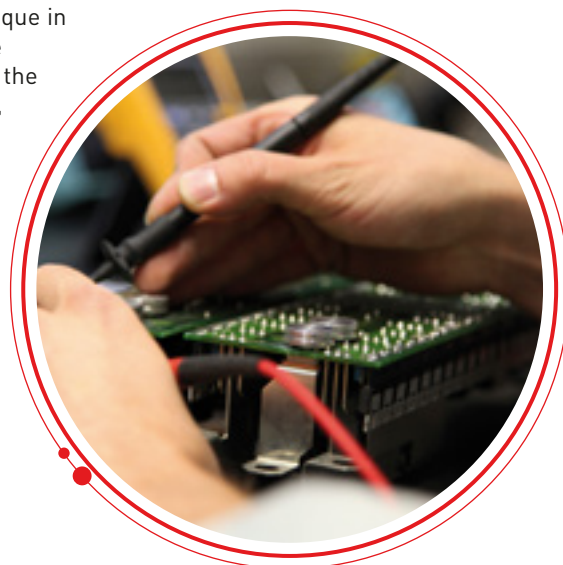

Discover our outlet store with new and second-hand products at rock-bottom prices.

Go to [www.tvh.com/tvhbay](http://www.tvh.com/tvhbay)



**Visit our webshop whenever and wherever you want.**

Request your login details now and benefit from the many advantages offered in MyTotalSource!



Discover the possibilities of the **MyTotalSource app**.

The MyTotalSource app offers you the possibility to request offers, place orders and scan bar codes of references from your smartphone.

For any questions, call or mail our help desk for free support:

**T +32 56 43 48 66**  
[ecommerce@tvh.com](mailto:ecommerce@tvh.com)

# www.tvh.com

## TVHEQUIPMENT

### SECOND-HAND EQUIPMENT & ELECTRIC WAREHOUSING



- 600 lift trucks in stock
- 300 aerial work platforms
- Telehandlers and all-terrain trucks
- Masts and attachments

Go to [myequipmentfinder.tvh.com](http://myequipmentfinder.tvh.com)





## CATALOGUES

Our catalogues give you information about the product groups, brands and makes in our range. The extensive and detailed information contains general product info, pictures and/or dimensions.

- REF 21713862 Consumables & accessories
- REF 29193029 Attachments & handling equipment
- REF 25564923 Batteries, chargers & accessories
- REF 20177702 Brushes
- REF 37474860 Chains & accessories
- REF 10185471 Contactors & contacts
- REF 21178582 Electronic accessories
- REF 31072159 Energic Plus
- REF 34167446 Engine parts
- REF 10727802 Exhaust systems
- REF 33113100 Fluke
- REF 20177906 Fuses & fuse holders
- REF 29127398 Grammer seats
- REF 31331437 Hydraulic parts & accessories
- REF 19949421 Key switches
- REF 12594102 Labels & decals
- REF 31072165 Lights & bulbs
- REF 22802499 LPG system parts
- REF 7872482 Mast rollers
- REF 26501928 Paint & accessories
- REF 31072162 Pallet truck parts
- REF 7835233 Potentiometers & encoders
- REF 7083552 Relays
- REF 12726578 Replacement parts for Genie
- REF 15069637 Replacement parts for Haulotte
- REF 12613028 Replacement parts for JLG
- REF 20769251 Replacement parts for scrubbers & sweepers
- REF 24154086 Replacement parts for tail lifts
- REF 27506014 Seats & accessories
- REF 6252659 Starters & alternators
- REF 34744204 Tracks & undercarriage parts
- REF 24337660 Tyres, rims & accessories
- REF 7072186 Wheel brake & master cylinders
- REF 31072155 Wheels, rollers & castors
- REF 34609026 Windshields & glazing
- Range of filters available in MyProductSearch & MyPartsFinder

## PRODUCT SPECIALS

We gladly keep you informed of our extensive product range. In addition to our catalogues we present you our 'product specials': useful brochures that will guide you within specific product categories.



- REF 31346611 Air conditioning
- REF 14372877 Document & accessories holders
- REF 21735662 Drum handling & accessories
- REF 31642339 Electronic accessories
- REF 22835159 Force professional tools
- REF 38742387 Forks & accessories
- REF 21720627 Hardware special
- REF 21713854 Hydraulic power units
- REF 18178749 Jacks & supports
- REF 22775197 LED lights
- REF 38088053 LED lights & consumables for trailer-mounted equipment
- REF 21841408 Lubrication & accessories
- REF 20778928 Mirrors
- REF 37575584 Personal care & cleaning products
- REF 17868205 Press special
- REF 28975226 Safety equipment for aerial work platforms
- REF 31773321 Safety products
- REF 20963014 Skips, scoops & crane jibs
- REF 33349886 Stainless steel handling products
- REF 36108454 Summertime products
- REF 19550195 Twistlocks special
- REF 33825047 Winter products



<b>About TVH</b> .....	<b>I</b>	<b>Over TVH</b> .....	<b>I</b>
<b>Nice to know</b> .....	<b>1</b>	<b>Goed om te weten</b> .....	<b>1</b>
<b>Interior lights</b> .....	<b>9</b>	<b>Interieurverlichting</b> .....	<b>9</b>
<b>Front lights</b> .....	<b>15</b>	<b>Voorlichten</b> .....	<b>15</b>
<b>Indicator lights</b> .....	<b>31</b>	<b>Knipperlichten</b> .....	<b>31</b>
<b>Rotating/flashing beacons</b> .....	<b>45</b>	<b>Zwaaï-/flitslichten</b> .....	<b>45</b>
<b>Rear lights</b> .....	<b>89</b>	<b>Achterlichten</b> .....	<b>89</b>
<b>Reflectors</b> .....	<b>135</b>	<b>Reflectoren</b> .....	<b>135</b>
<b>Marker lights</b> .....	<b>149</b>	<b>Markeringslichten</b> .....	<b>149</b>
<b>License plate lights</b> .....	<b>159</b>	<b>Nummerplaatverlichting</b> .....	<b>159</b>
<b>Safety lights</b> .....	<b>163</b>	<b>Veiligheidslichten</b> .....	<b>163</b>
<b>Work lights</b> .....	<b>169</b>	<b>Werklichten</b> .....	<b>169</b>
<b>Portable lights</b> .....	<b>195</b>	<b>Draagbare verlichting</b> .....	<b>195</b>
<b>Premium bulbs</b> .....	<b>203</b>	<b>Premium lampen</b> .....	<b>203</b>
<b>Flashtubes</b> .....	<b>213</b>	<b>Flitsbuizen</b> .....	<b>213</b>
<b>Incandescent bulbs</b> .....	<b>219</b>	<b>Gloeilampen</b> .....	<b>219</b>
<b>Halogen bulbs</b> .....	<b>245</b>	<b>Halogeenlampen</b> .....	<b>245</b>
<b>Fluorescent bulbs</b> .....	<b>255</b>	<b>Fluorescentielampen</b> .....	<b>255</b>
<b>High intensity discharge bulbs</b> .....	<b>259</b>	<b>Hogedruk gasontladingslampen</b> .....	<b>259</b>
<b>Spare kits/dashboard bulbs</b> .....	<b>263</b>	<b>Reservesets/dashboardlampen</b> .....	<b>263</b>
<b>Maintenance, repair &amp; operation</b> .....	<b>273</b>	<b>Onderhoud &amp; reparatie</b> .....	<b>273</b>



À propos de TVH .....	I
Bon à savoir .....	1
Éclairage intérieur .....	9
Phares avant .....	15
Feux clignotants .....	31
Gyrophares / feux à éclats .....	45
Feux arrière .....	89
Catadioptrés .....	135
Feux d'encombrement .....	149
Feux de plaque d'immatriculation .....	159
Avertisseurs lumineux .....	163
Lampes de travail .....	169
Lampes portables .....	195
Ampoules premium .....	203
Tubes-éclairs .....	213
Lampes à incandescence .....	219
Ampoules halogènes .....	245
Lampes fluorescentes .....	255
Lampes à décharge haute intensité .....	259
Kits de pièces détachées / ampoules pour tableau de bord .....	263
Maintenance, réparation & opération .....	273

Über TVH .....	I
Gut zu wissen .....	1
Innenleuchten .....	9
Frontleuchten .....	15
Kontrollleuchten .....	31
Rundum-/Blitzleuchten .....	45
Rückleuchten .....	89
Reflektoren .....	135
Markierungsleuchten .....	149
Kennzeichenleuchten .....	159
Sicherheitsleuchten .....	163
Arbeitsleuchten .....	169
Handleuchten .....	195
Premium-Glühlampen .....	203
Blitzröhre .....	213
Glühlampen .....	219
Halogenlampen .....	245
Fluoreszierende Lampen .....	255
Hochdruckentladungslampen .....	259
Ersatzteilsätze/ Lampen für Armaturenbretter .....	263
Wartung, Reparatur & Instandhaltung .....	273





Sobre TVH .....	I
Es bueno saber .....	1
Luces para la cabina .....	9
Luces frontales .....	15
Luces indicadoras .....	31
Intermitentes .....	45
Faros traseros .....	89
Reflectores .....	135
Luces de gálibo .....	149
Luces para matrícula .....	159
Luces de seguridad .....	163
Faros de trabajo .....	169
Luces portátiles .....	195
Lámparas premium .....	203
Tubos de flash .....	213
Lámparas incandescentes .....	219
Lámparas halógenas .....	245
Lámparas fluorescentes .....	255
Lámparas de descarga de alta intensidad .....	259
Kit de repuestos/ lámparas tablero de mandos .....	263
Mantenimiento, reparación & operaciones .....	273

Sobre a TVH .....	I
Bom saber .....	1
Luces interiores .....	9
Faróis da frente .....	15
Luces indicadoras .....	31
Faróis rotativos/de flash .....	45
Faróis traseiros .....	89
Refletores .....	135
Luces de marcação .....	149
Luz de chapa de matrícula .....	159
Luces de segurança .....	163
Faróis de trabalho .....	169
Faróis portáteis .....	195
Lâmpadas premium .....	203
Tubos de flash .....	213
Lâmpadas incandescentes .....	219
Lâmpadas halogénio .....	245
Lâmpadas fluorescentes .....	255
Lâmpadas de descarga de alta intensidade .....	259
Kits de reposição/lâmpadas de painel .....	263
Manutenção, reparação & operação .....	273



Circa TVH .....	I	O TVH .....	I
Utile da sapere .....	1	Dobrze wiedzieć .....	1
illuminazione interna .....	9	Światła wewnętrzne .....	9
Luci frontali .....	15	Światła przednie .....	15
Indicatori di direzione .....	31	Kierunkowskazy .....	31
Fari rotanti/lampeggianti .....	45	Światła rotacyjne/migające .....	45
Fari posteriori .....	89	Światła tylne .....	89
Catarifrangenti .....	135	Reflektory .....	135
Luci di segnalazione .....	149	Światła ostrzegawcze .....	149
Luci targa .....	159	Światło do podświetlania tablic rejestracyjnych .....	159
Luci di sicurezza .....	163	Światła awaryjne .....	163
Fari da lavoro .....	169	Światła robocze .....	169
Luci portatili .....	195	Przenośne światła .....	195
Lampadine premium .....	203	Żarówki Premium .....	203
Stroboscopi .....	213	Lampy błyskowe .....	213
Lampadine a incandescenza .....	219	Żarówki .....	219
Lampade alogene .....	245	Żarówki halogenowe .....	245
Lampade fluorescenti .....	255	Żarówki fluorescencyjne .....	255
Lampade a scarica ad alta intensità .....	259	Żarówki wyładowcze dużej intensywności .....	259
Kits di ricambi/lampade cruscotto .....	263	Zestawy/Żarówki do deski rozdzielczej .....	263
Manutenzione, riparazione & operazione .....	273	Konserwacja, naprawa i działanie .....	273



Кратко о TVH .....	I
Полезно знать .....	1
Внутреннее освещение .....	9
Передние фары .....	15
Световые индикаторы .....	31
Вращающиеся/проблесковые маячки .....	45
Задние фары .....	89
Отражатели .....	135
Маркировочная сигнализация .....	149
Подсветка для лицензионного номера .....	159
Контрольные лампы безопасности .....	163
Рабочее освещение .....	169
Переносные фонари .....	195
Лампочки высокого качества .....	203
Импульсные лампы .....	213
Лампы накаливания .....	219
Галогенные лампы .....	245
Люминесцентные лампы .....	255
Лампы с разрядом высокой интенсивности .....	259
Комплекты/лампы приборной панели .....	263
Техническое обслуживание, ремонт и эксплуатация .....	273



NOTES

A series of horizontal dotted lines for writing notes.



**NICE TO KNOW**



## NICE TO KNOW – GENERAL

### Structure of the catalogue

The lights in this catalogue were split up according to the type (interior lighting, indicator lights, rotating beacons ...). The classification of these different types occurs according to the following criteria:

- Shape (round, rectangular or special shapes)
- Technology (LED, xenon, halogen or incandescent bulb)
- Dimensions

The chapter 'Work lights' is an exception to this classification. In this chapter all LED work lights have been classified according to the Lumen.

The lights that are suitable for use on public roads are marked with the marking 'E-approved'.

Some of the lights have a different design because they are only used at the left- or right-hand side of the machine. This is indicated by LH (left-hand side) and RH (right-hand side).

It's important what side is indicated with LH and RH. The drawing on the right can help you.

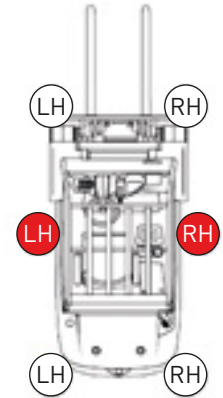

### IP-ratings

IP ratings in general specify the protection of enclosures of electronic equipment from dust, solid objects and fluids. The first number refers to the protection against dust and solid objects. The second number refers to the protection against fluids and moisture.

Protection against solid objects and dust			
First Number	Description/Test	Second Number	Description/Test
X	Not tested	X	Not tested
0	No protection	0	No protection
1	Protection against solid objects over 50 mm, e.g. accidental touch by hands	1	Protection against vertically falling drops of water
2	Protection against solid objects over 12 mm, e.g. fingers	2	Protection against direct sprays of water up to 15 degrees
3	Protection against solid objects over 2,5 mm (tools/wires)	3	Protection against sprays to 60 degrees
4	Protection against solid objects over 1 mm (tools/wires/small wires)	4	Protection against water sprayed from all directions – limited ingress permitted
5	Protection against dust – limited ingress (no harmful deposit)	5	Protection against low-pressure jets of water from all directions – limited ingress permitted
6	Total protection against dust	6	Protection against strong jets of water, e.g. for use on ship decks – limited ingress permitted
		7	Protection against the effects of immersion between 15 cm and 1 m
		8	Protection against long periods of immersion under pressure

Remark: There are IP values which are followed by the character 'K', e.g. IP5K4K

The K indicates that the light has been tested with an increased pressure and will not have any damaging effects.

Using the previous example IP5K4K, this IP value indicates that dust parts can only enter in a very small degree so that the operation or safety is guaranteed. Water sprayed from all directions under increased pressure won't have a damaging effect on the housing. The water pressure will be around 4 bar.

IP6K4K indicates there is no dust allowed to enter. The protection against water is the same as IP5K4K.



## NICE TO KNOW – BULBS



### Quality of light

- Intensity of light (candela, cd)  
The total amount of light emitted by a light source in a certain direction
- Luminous flux (Lumen, lm)  
Total amount of light emitted by a light source per second
- Illuminance (lux, lx)  
The total amount of light incident on a fixed surface
- Colour temperature

### Intensity of light

The intensity of light is the total amount of light emitted by a light source. A light source often radiates in different directions with varying power. The intensity of light is the radiation of light in a certain direction. The unit of light intensity is candela [cd].

### Luminous flux

Luminous flux is the amount of light a light source radiates in all directions per unit of time (per second). Luminous flux equals energy per unit of time and is expressed in watt. In lighting technology, the unit Lumen [lm] is used. Watt and Lumen have a ratio of: 1 watt = 683 Lumen

### Illuminance

Illuminance [lx] is the total amount of light incident on a surface. Illuminance is about incident light and not emitted light. The unit lux [lx] is used to express illuminance.

### Luminance

Luminance [cd/m<sup>2</sup>] is the amount of light emitted or reverberated per unit of surface. Luminance is expressed as candela per square meter.

### Colour temperature (Kelvin)

The colour temperature of a light source is the temperature of an ideal black-body radiator that radiates light of comparable hue to that of the light source. Colour temperature is expressed in Kelvin [K]. The wavelength of the emitted light decreases as the temperature rises. Blue light (short wavelength) has a higher colour temperature than red hues. Strangely enough, light with a low colour temperature is often experienced as warmer than light with a high colour temperature. An incandescent light bulb with warm white light has a temperature of 2700 K, a fluorescent bulb with natural light has a colour temperature of 6000 K.

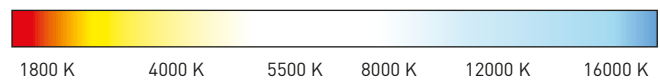

### Examples

Temperature (Kelvin)	Description
1200	Candlelight
2000	Incandescent bulb
3200	Halogen bulb
5400	Standard value of a television
6000	Afternoon sun



## NICE TO KNOW – CONNECTORS

### Connectors

A lot of our lights are equipped with a connector. Each connector has a code: the number of that code indicates the number of possible connections of the connector. The letter is the position of the connector in the list of connectors.

Each light with at least one connector will be marked with the right connector code. This will make it easy for you to find the corresponding connector for a specific light.

If you are looking for a specific light for your machine, you can easily look up your lights via our online search engine MyPartsFinder by means of the truck details.

## CONNECTORS – 1 PIN







## CONNECTORS – 2 PINS



A2



B2



AMP C2



D2



Deutsch E2



F2



AMP G2



H2



I2

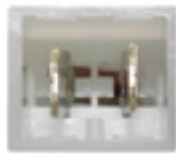

J2



K2

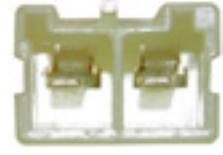

L2



M2



## CONNECTORS – 3 PINS



## CONNECTORS – 4 PINS





## CONNECTORS – 5 PINS



A5



B5



C5



D5



E5

## CONNECTORS – 6 PINS



A6



B6



Deutsch C6



Deutsch D6

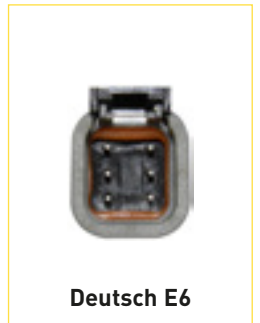

Deutsch E6



AWP F6



G6



H6



I6

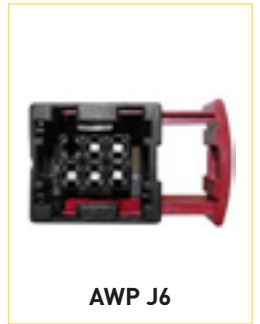

AWP J6



K6



L6



M6



N6



O6



P6



Q6



## CONNECTORS – 7 PINS

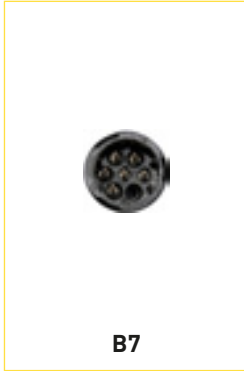

## CONNECTORS – 8 PINS





# INTERIOR LIGHTS



## NICE TO KNOW – INTERIOR LIGHTS



The range of interior lighting consists of both fixed (ceiling) and gooseneck models. The latter have a flexible neck, allowing you to bend the light so it shines in the desired direction.

Interior lighting enables you to easily read documents (delivery notes, instructions, drawings ...) inside the driver cabin, or can provide extra lighting for the operating panel. Ideal to use in dark conditions.



## READING LIGHTS

**REF 151TA3929** – 12V length: 195 mm

**REF 151TA3927** – 12V length: 600 mm

- Technology: incandescent
- Flexible arm
- Installation: surface-mounted, screw attachment
- Bulb included

**REF 103TA4572** – Bulb: BA9S 12V 4W

**REF 136TA3028** – Bulb: BA9S 12V 5W

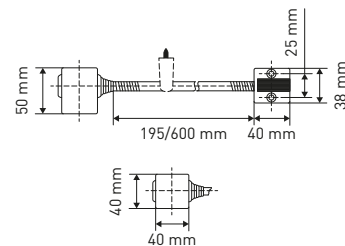

**REF 151TA3928** – 24V length: 600 mm

- Technology: xenon
- Flexible arm
- Length: 500 mm
- Installation: surface-mounted, screw attachment
- With on/off switch
- Bulb included

**REF 141TA9759** – Bulb: BA9S 28V 7,5W

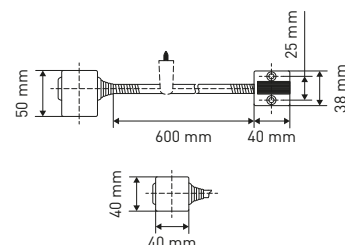



## INTERIOR LIGHTS

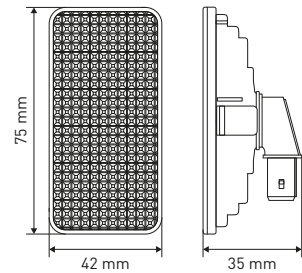

- REF 151TA3940** – 12V
- Technology: incandescent
  - Used on Linde
  - Bulb included

**REF 103TA4555** – Bulb: W2,1x9,5D 12V 5W

**TOTAL SOURCE®**

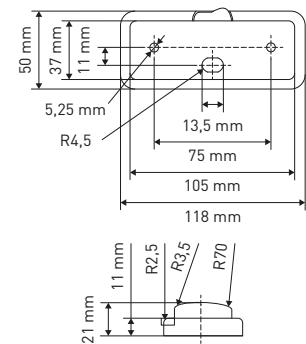

- REF 151TA3938**
- Technology: incandescent
  - Center distance: 75 mm
  - Installation: surface mounting 2 screws
  - 3 functions switch
  - 12–24V
  - Bulbs not included

**REF 103TA4537** – Bulb: SV8,5-8 12V 5W

**REF 103TA4539** – Bulb: SV8,5-8 24V 5W

**TOTAL SOURCE®**

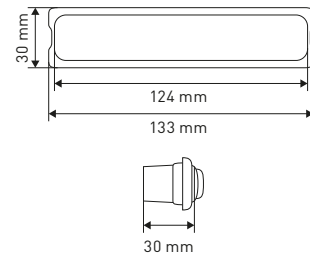

- REF 151TA3939**
- Technology: incandescent
  - Installation: surface mounting
  - 3 functions switch
  - 12–24V
  - Bulbs not included

**REF 106TA4831** – Bulb: SV8,5-8 12V 10W

**REF 106TA4907** – Bulb: SV8,5-8 24V 10W

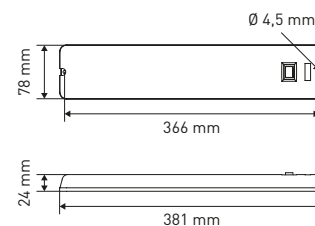

- REF 151TA3933** – 48V
- Technology: tube
  - Very low profile (24 mm)
  - Center distance: 366 mm
  - Tough polycarbonate lens
  - Tube included

**REF 136TA3029** – Tube: G5 8W 4100K

**REF 149TA7609** – Lens

**TOTAL SOURCE®**





## INTERIOR LIGHTS

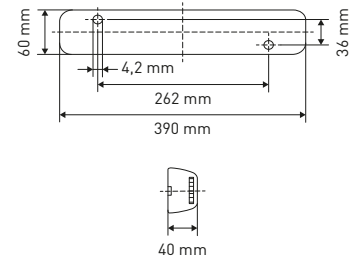

**REF 129TA9944** – 24V

- Technology: tube
- Center distance: 262 mm
- Installation: surface mounting
- 3-functions switch integrated
- Tube included

**REF 136TA3029** – Tube: G5 8W 4100K

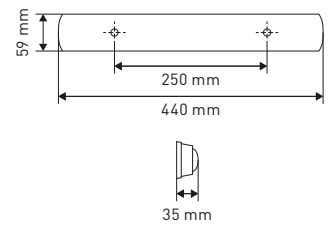

**REF 151TA3936** – 12V

**REF 140TA8987** – 24V

- Technology: tube
- Center distance: 250 mm
- Installation: surface mounting
- On/off switch integrated
- Tube included

**REF 136TA3029** – Tube: G5 8W 4100K

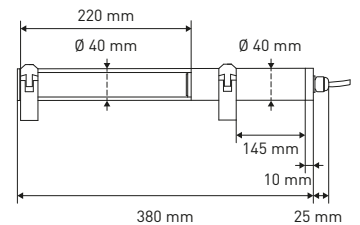

**REF 151TA3930** – 24V

- Technology: tube
- IP65
- Protection class: II
- Cable: 5 m
- Tube included

**REF 142TA1335** – Tube: G23 11W 4000K

**REF 164TA1118** – Mounting clamp





NOTES

A series of horizontal dotted lines for writing notes.



# FRONT LIGHTS



## NICE TO KNOW – FRONT LIGHTS



Front lights have a double function: they make sure that the vehicle is seen, while simultaneously making sure that the driver can see better.

They illuminate the surface in front of the vehicle by means of a bulb, mirror and lens. The beam of the dimmed headlights is directed downwards to prevent oncoming vehicles from being blinded.

Front lights are sometimes built into the machine, but they can also be installed on the machine.

Front lights are available in different shapes or models and technologies. There are front lights available with just one function, but there are also front lights that have multiple functions. These models are equipped with an indicator light, parking light, dimmed headlight or high-beam headlight, or a combination of these.



## FRONT DRIVING LIGHTS

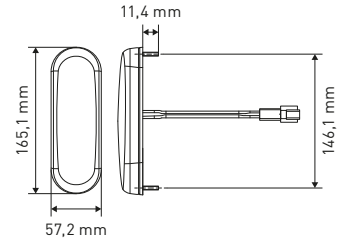

**REF 151TA3285** – 12-48V without connector

**REF 151TA3269** – 12-48V with connector F3

- Technology: LED
- Mounting: 2 bolts
- Wire length: 185 mm
- Functions: parking, turn
- IP67

**E-approved**

**TOTAL SOURCE®**

BRAND: SPEAKER

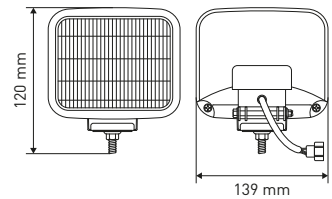

**REF 151TA3212** – 24V

- Technology: incandescent
- Mounting: pedestal
- Wire length: 200 mm
- Functions: parking, dimmer
- Bulb included
- Connector: A3

**REF 100TA2281** – Bulb: P15D 24V 62W/62W

**TOTAL SOURCE®**

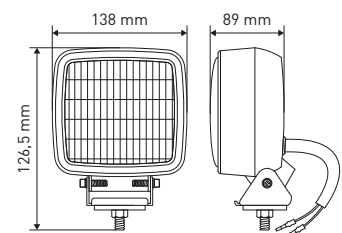

**REF 151TA3213** – 48V

- Technology: incandescent
- Mounting: pedestal
- Wire length: 230 mm
- Function: dimmer
- Bulb included
- Connector: 2 x G1

**REF 103TA4632** – Bulb: BA15S 48V 45W

**REF 151TA3214** – Replacement lens

**REF 151TA3152** – Bracket

**TOTAL SOURCE®**



## FRONT DRIVING LIGHTS

### REF 151TA3199 – 12V

- Technology: incandescent
- Mounting: 2 bolts
- Center distance: 58 mm
- Wire length: 285 mm
- Functions: parking, dimmer
- Bulbs included
- Connector: 1 x A1, 2 x G1

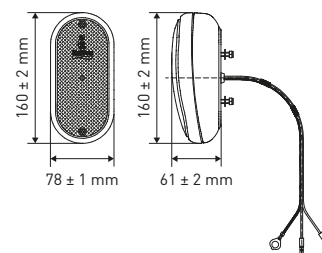

### REF 103TA4585 – Bulb: BA15S 12V 5W

### REF 122TA9122 – Bulb: BA15S 12V 21W orange

**E-approved**

**TOTAL SOURCE®**

BRAND: BRITAX

### REF 151TA3282 – 12V LH

### REF 151TA3283 – 12V RH

- Technology: halogen/incandescent
- Mounting: pedestal
- Wire length: 1000 mm
- Functions: parking, dimmer, turn
- Bulbs included
- Used on Heli



LH



RH

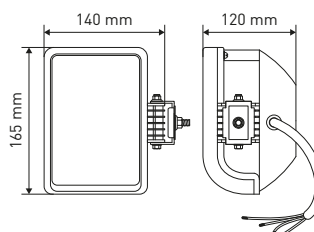

### REF 142TA1238 – Bulb: W2,1x9,5D 12V 3,4W

### REF 122TA9122 – Bulb: BA15S 12V 21W orange

### REF 123TA8007 – Bulb: H3 12V 55W

**TOTAL SOURCE®**

### REF 151TA3276 – 12V

- Technology: halogen/incandescent
- Mounting: single bolt
- Wire length: 1160 mm
- Functions: parking, dimmer, turn
- Bulbs included
- Connector: G4

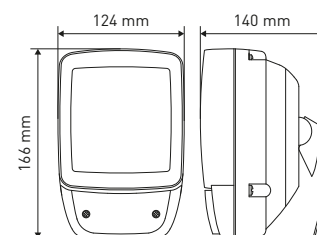

### REF 103TA4572 – Bulb: BA9S 12V 4W

### REF 103TA4596 – Bulb: BA15S 12V 10W

### REF 123TA8007 – Bulb: H3 12V 55W

**TOTAL SOURCE®**



## FRONT DRIVING LIGHTS

**REF 151TA3305** – 12V LH

**REF 151TA3306** – 12V RH

- Technology: halogen/incandescent
- Mounting: built-in
- Wire length: 150 mm
- Functions: parking, dimmer, turn
- Bulbs included
- Used for Toyota 7 series new model
- Connector: K6

**REF 122TA9117** – Bulb: BA9S 12V 5W

**REF 122TA9122** – Bulb: BA15S 12V 21W orange

**REF 103TA4525** – Bulb: H3 12V 55W

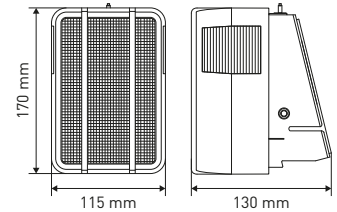

**TOTAL SOURCE®**

**REF 151TA3154** – 12V LH

**REF 151TA3155** – 12V RH

- Technology: halogen/incandescent
- Mounting: built-in
- Wire length: 220 mm
- Functions: parking, dimmer, turn
- Bulbs included
- Used for Toyota 7 series old model
- Connector: F3, B2

**REF 122TA9117** – Bulb: BA9S 12V 5W

**REF 122TA9122** – Bulb: BA15S 12V 21W orange

**REF 103TA4525** – Bulb: H3 12V 55W

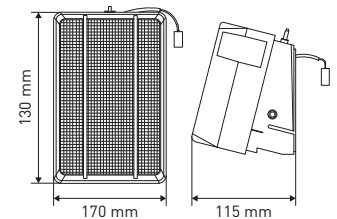

**TOTAL SOURCE®**

**REF 152TA2445** – 12V LH

**REF 148TA4739** – 12V RH

- Technology: halogen/incandescent
- Mounting: built-in
- Wire length: 100 mm
- Functions: parking, dimmer, turn
- Bulbs included
- Used for Toyota 7 series new model
- Connector: C3, L2

**REF 103TA4555** – Bulb: W2,1x9,5D 12V 5W

**REF 140TA8980** – Bulb: BAU15S 12V 21W orange

**REF 103TA4525** – Bulb: H3 12V 55W

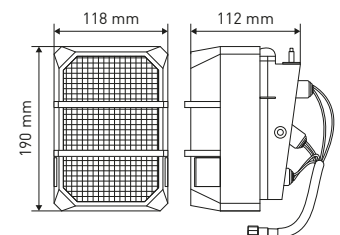

**TOTAL SOURCE®**



## FRONT DRIVING LIGHTS

**REF 151TA3329** – 48V LH

**REF 151TA3330** – 48V RH

- Technology: incandescent
- Mounting: built-in
- Wire length: 220 mm
- Bulbs included
- Connector: K6

**REF 103TA4598** – Bulb: BAY15D 48V 10W

**REF 103TA4625** – Bulb: BAY15D 48V 25W

**REF 103TA4636** – Bulb: BAY15D 48V 40W

**REF 150TA1244** – Replacement lens

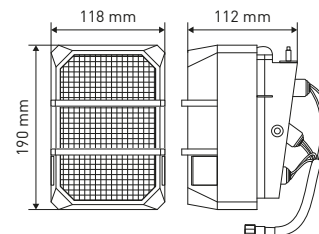

**TOTAL SOURCE®**

**REF 151TA3284** – 12V

- Technology: halogen/incandescent
- Mounting: single bolt
- Wire length: 1230 mm
- Functions: parking, dimmer, turn
- Bulbs included
- Connector: F4

**REF 103TA4575** – Bulb: BA9S 12V 4W

**REF 122TA9113** – Bulb: BA15S 12V 21W

**REF 123TA8007** – Bulb: H3 12V 55W

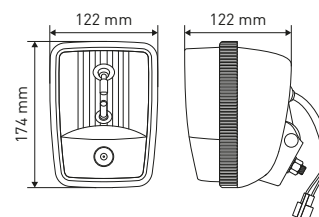

**TOTAL SOURCE®**

**REF 151TA3203** – 12V LH

**REF 151TA3204** – 12V RH

**REF 151TA3205** – 48V LH

**REF 151TA3206** – 48V RH

- Technology: halogen/incandescent
- Mounting: support
- Wire length: 125 mm
- Functions: parking, dimmer, turn
- Bulbs included
- Connector: A6

**REF 100TA2164** – Bulb: BA9S 12V 4W

**REF 122TA9113** – Bulb: BA15S 12V 21W

**REF 119TA8915** – Bulb: BA9S 48V 4W

**REF 103TA4636** – Bulb: BAY15D 48V 40W

**REF 151TA3209** – Support

**REF 151TA3207** – Clear lens

**REF 151TA3208** – Amber lens

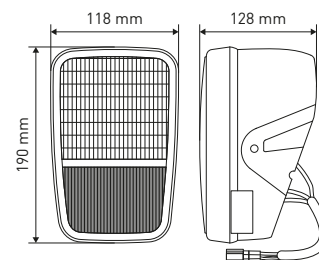

**TOTAL SOURCE®**





## FRONT DRIVING LIGHTS

- REF 151TA3278** – 48V LH
- REF 151TA3277** – 48V RH
- Technology: incandescent
- Mounting: support
- Wire length: 230 mm
- Functions: dimmer, turn signal
- Bulbs included
- Connector: L4

- REF 123TA7992** – Bulb: BAY15D 48V 25W
- REF 103TA4636** – Bulb: BAY15D 48V 40W
- REF 151TA3209** – Support
- REF 151TA3207** – Clear lens
- REF 151TA3208** – Amber lens

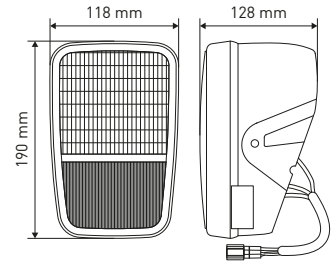

**TOTAL SOURCE®**

- REF 151TA3316** – LH
- REF 151TA3317** – RH
- Technology: halogen/incandescent
- Mounting: 4-point fixing (internal)
- 12–24V
- Bulbs not included

- REF 106TA4826** – Bulb: P45T-41 12V 45/40W
- REF 103TA4574** – Bulb: BA9S 12V 2W
- REF 103TA4576** – Bulb: BA9S 24V 2W
- REF 106TA4827** – Bulb: P45T-41 24V 55/50W

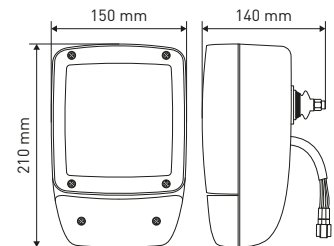

**COBO®**  
*grow*

**E-approved**

- REF 151TA3301** – 12V Deutsch connection
- REF 151TA3302** – 24V Deutsch connection
- REF 151TA3303** – 12V AMP-connection
- REF 151TA3304** – 24V AMP-connection
- Technology: halogen/incandescent
- Mounting: support
- Functions: parking, dimmer, turn
- Bulbs included

- REF 103TA4572** – Bulb: BA9S 12V 4W
- REF 140TA8980** – Bulb: BAU15S 12V 21W orange
- REF 106TA4908** – Bulb: H7 12V 55W
- REF 106TA4840** – Bulb: BA9S 24V 4W
- REF 140TA8979** – Bulb: BAU15S 24V 21W orange
- REF 106TA4909** – Bulb: H7 24V 70W

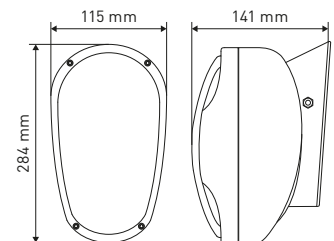

**Deutsch connector**



**AMP connector**



**HELLA**

**E-approved**



## FRONT DRIVING LIGHTS

**REF 151TA3292** – 12V

**REF 151TA3294** – 24V

- Technology: halogen/incandescent
- Mounting: single bolt
- Functions: parking, dimmer, head, turn
- Bulbs included

**REF 103TA4572** – Bulb: BA9S 12V 4W

**REF 100TA2215** – Bulb: BA15S 12V 21W

**REF 106TA4825** – Bulb: H4 12V 60/55W

**REF 106TA4840** – Bulb: BA9S 24V 4W

**REF 103TA4603** – Bulb: BA15S 24V 21W

**REF 106TA4822** – Bulb: H4 24V 75/70W

**REF 150TA4754** – Turn indicator lens

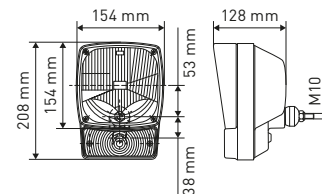

E-approved

**REF 151TA3273** – 12V

- Technology: halogen/incandescent
- Mounting: single bolt
- Wire length: 280 mm
- Functions: parking, dimmer, head, turn
- Bulbs included
- Connector: K6

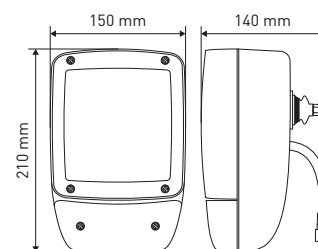

**REF 103TA4572** – Bulb: BA9S 12V 4W

**REF 100TA2215** – Bulb: BA15S 12V 21W

**REF 123TA8012** – Bulb: H4 12V 60/55W



E-approved

**REF 151TA3210** – 12V LH

**REF 151TA3211** – 12V RH

- Technology: halogen/incandescent
- Mounting: single bolt
- Functions: parking, dimmer, head, turn
- Bulbs included
- Connector: E5

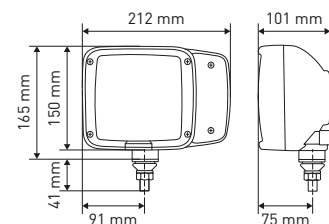

**REF 103TA4572** – Bulb: BA9S 12V 4W

**REF 100TA2215** – Bulb: BA15S 12V 21W

**REF 103TA4525** – Bulb: H3 12V 55W

**REF 106TA4909** – Bulb: H7 12V 55W

**REF 150TA3160** – Indicator lens

**REF 148TA5529** – Front light lens





## FRONT DRIVING LIGHTS

**REF 151TA3159** – 12V LH

**REF 151TA3160** – 12V RH

- Technology: halogen/incandescent
- Mounting: single bolt
- Functions: parking, dimmer, head, turn
- Bulbs included
- Connector: O6 built-in

**REF 103TA4572** – Bulb: BA9S 12V 4W

**REF 100TA2215** – Bulb: BA15S 12V 21W

**REF 103TA4525** – Bulb: H3 12V 55W

**REF 106TA4909** – Bulb: H7 12V 55W

**REF 148TA5529** – Front light lens

**REF 150TA3160** – Indicator lens

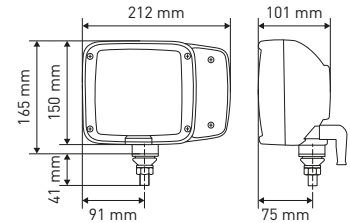

**E-approved**

**Left-driving traffic**

**TOTAL SOURCE®**

**REF 151TA3197** – 12V LH

**REF 151TA3198** – 12V RH

- Technology: halogen/incandescent
- Mounting: single bolt
- Functions: parking, dimmer, head, turn
- Bulbs included
- Connector: C6 built-in

**REF 103TA4575** – Bulb: BA9S 12V 4W

**REF 100TA2215** – Bulb: BA15S 12V 21W

**REF 103TA4525** – Bulb: H3 12V 55W

**REF 163TA8798** – Bulb: H7 12V 55W

**REF 150TA4544** – Replacement headlight glass

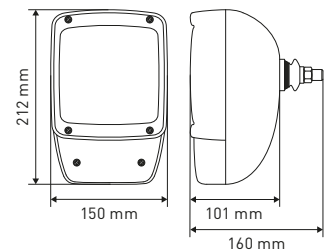

**E-approved**



**REF 151TA3279** – 12V LH

**REF 151TA3280** – 12V RH

- Technology: halogen/incandescent
- Mounting: single bolt
- Functions: parking, dimmer, head, turn
- Bulbs included
- Connector: C6 built-in

**REF 103TA4575** – Bulb: BA9S 12V 4W

**REF 100TA2215** – Bulb: BA15S 12V 21W

**REF 103TA4525** – Bulb: H3 12V 55W

**REF 163TA8798** – Bulb: H7 12V 55W

**REF 150TA4544** – Replacement headlight glass

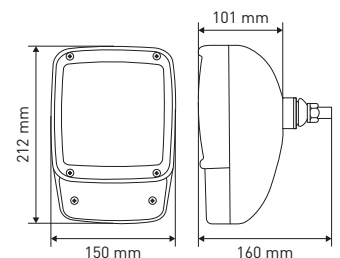

**E-approved**

**Left-driving traffic**





## FRONT DRIVING LIGHTS

**REF 151TA3200** – 12V LH

**REF 151TA3201** – 12V RH

- Technology: halogen/incandescent
- Mounting: single bolt
- Functions: parking, dimmer, head, turn
- Bulbs included
- Connector: E5

**REF 103TA4572** – Bulb: BA9S 12V 4W

**REF 100TA2215** – Bulb: BA15S 12V 21W

**REF 103TA4525** – Bulb: H3 12V 55W

**REF 106TA4909** – Bulb: H7 12V 55W

**REF 150TA3160** – Indicator lens

**REF 148TA5529** – Front light lens

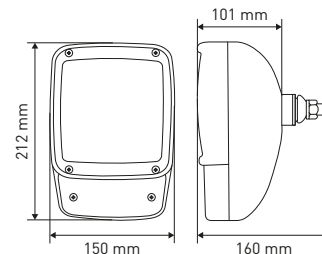

**E-approved**

**REF 151TA3202**

- Technology: halogen/incandescent
- Mounting: single bolt
- Functions: dimmer, head, turn
- 12-24V
- Bulbs not included

**REF 103TA4575** – Bulb: BA9S 12V 4W

**REF 103TA4530** – Bulb: H4 12V 60/55W

**REF 106TA4840** – Bulb: BA9S 24V 4W

**REF 123TA8013** – Bulb: H4 24V 75/70W

**REF 148TA5581** – Replacement lens

**REF 151TA3333** – Replacement lens amber

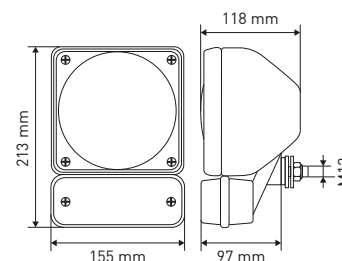

**E-approved**

**REF 151TA3156** – 12V LH

**REF 151TA3157** – 12V RH

- Technology: halogen/incandescent
- Center distance: 60 mm
- Functions: parking, dimmer, turn
- Bulbs included

**REF 103TA4575** – Bulb: BA9S 12V 4W

**REF 100TA2215** – Bulb: BA15S 12V 21W

**REF 106TA4825** – Bulb: H4 12V 60/55W

**REF 103TA4577** – Bulb: BA9S 24V 4W

**REF 103TA4603** – Bulb: BA15S 24V 21W

**REF 131TA4802** – Bulb: H4 24V 75/70W

**REF 159TA9757** – Replacement lens amber

**REF 150TA4948** – Replacement lens and cover

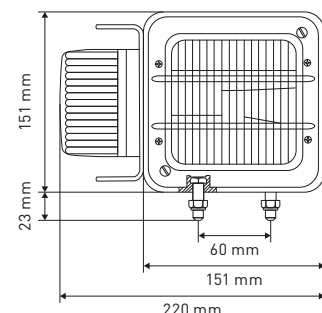

**E-approved**



## FRONT DRIVING LIGHTS

REF [151TA3297](#) – 12V LH

REF [151TA3298](#) – 12V RH

REF [151TA3299](#) – 24V LH

REF [151TA3300](#) – 24V RH

- Technology: halogen/incandescent
- Mounting center distance: 60 mm
- Bulbs included
- Functions: parking, dimmer, turn

REF [103TA4575](#) – Bulb: BA9S 12V 4W

REF [100TA2215](#) – Bulb: BA15S 12V 21W

REF [106TA4825](#) – Bulb: H4 12V 60/55W

REF [103TA4577](#) – Bulb: BA9S 24V 4W

REF [103TA4603](#) – Bulb: BA15S 24V 21W

REF [131TA4802](#) – Bulb: H4 24V 75/70W

REF [159TA9757](#) – Replacement lens amber

REF [150TA4948](#) – Replacement lens and cover

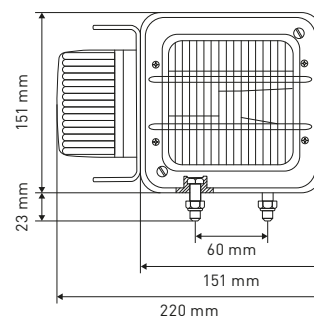

**E-approved**

REF [151TA3264](#) – 12V LH

REF [151TA3263](#) – 12V RH

- Technology: halogen/incandescent
- Mounting: single bolt
- Functions: parking, dimmer, head, turn
- Bulbs included
- Connector: C6 built-in

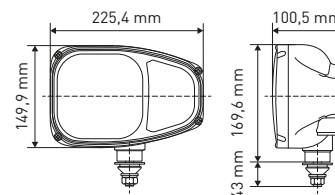

**E-approved**

REF [151TA3286](#) – 12V

REF [151TA3287](#) – 24V

- Technology: halogen/incandescent
- Mounting: single bolt
- Functions: parking, dimmer, head, turn
- Bulbs included
- Connector: C6 built-in

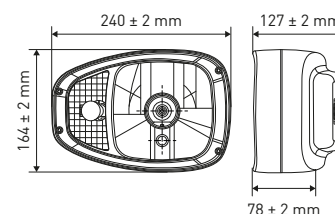

**E-approved**

REF [103TA4555](#) – Bulb: W2,1x9,5D 12V 5W

REF [140TA8980](#) – Bulb: BAU15S 12V 21W orange

REF [103TA4530](#) – Bulb: H4 12V 60/55W

REF [100TA2148](#) – Bulb: W 2,1x9,5D 24V 5W

REF [140TA8979](#) – Bulb: BAU15S 24V 21W orange

REF [100TA2105](#) – Bulb: H4 24V 75/70W



## FRONT DRIVING LIGHTS

**REF 151TA3295** – 12V LH

**REF 151TA3296** – 12V RH

- Technology: halogen/incandescent
- Mounting: single bolt
- Wire length: 220 mm
- Functions: parking, dimmer, head, turn
- Bulbs included
- Connector: D6

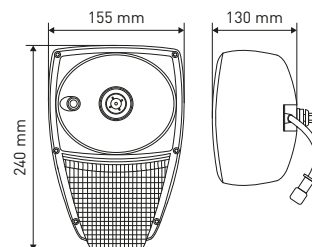

**REF 103TA4572** – Bulb: BA9S 12V 4W

**REF 140TA8980** – Bulb: BAU15S 12V 21W orange

**REF 123TA8012** – Bulb: H4 12V 60/55W

**E-approved**

**TOTAL SOURCE**  
BRAND: NORDIC LIGHTS

**REF 151TA3288** – 12V LH

**REF 151TA3289** – 12V RH

**REF 151TA3290** – 24V LH

**REF 151TA3403** – 24V RH

- Technology: halogen/incandescent
- Mounting: single bolt
- Functions: parking, dimmer, head, turn
- IP69
- Bulbs included
- Connector: D6 built-in

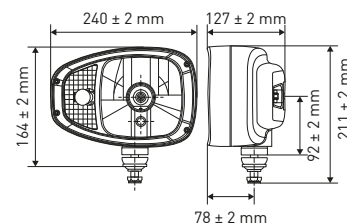

**REF 103TA4572** – Bulb: BA9S 12V 4W

**REF 140TA8980** – Bulb: BAU15S 12V 21W orange

**REF 123TA8012** – Bulb: H4 12V 60/55 W

**REF 106TA4840** – Bulb: BA9S 24V 4W

**REF 140TA8979** – Bulb: BAU15S 24V 21W orange

**REF 123TA8013** – Bulb: H4 24V 75/70W

**E-approved**

**ABL**

**REF 151TA3320** – 12V LH

**REF 151TA3321** – 12V RH

- Technology: halogen/incandescent
- Mounting: single bolt
- Functions: parking, dimmer, head, turn
- Bulbs included
- Connector: C6 built-in

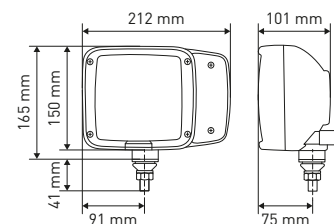

**REF 103TA4572** – Bulb: BA9S 12V 4W

**REF 100TA2215** – Bulb: BA15S 12V 21W

**REF 103TA4525** – Bulb: H3 12V 55W

**REF 106TA4909** – Bulb: H7 12V 55W

**REF 148TA5529** – Replacement lens front light

**REF 150TA3160** – Indicator lens

**E-approved**

**HELLA**



## FRONT DRIVING LIGHTS

- REF 151TA3393** – 12V LH  
**REF 151TA3394** – 12V RH
- Technology: halogen/incandescent
  - Mounting: single bolt
  - Functions: parking, dimmer, head, turn signal
  - Bulbs included
  - Connector: D6 built-in

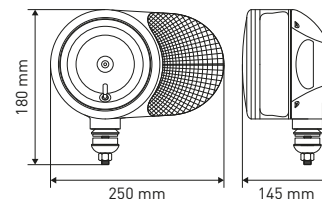

- REF 103TA4575** – Bulb: BA9S 12V 4W  
**REF 140TA8980** – Bulb: BAU15S 12V 21W orange  
**REF 123TA8012** – Bulb: H4 12V 60W

**E-approved**



- REF 151TA3325** – 12V LH  
**REF 151TA3326** – 12V RH  
**REF 151TA3327** – 24V LH  
**REF 151TA3328** – 24V RH
- Technology: halogen/incandescent
  - Center distance: 60 mm
  - Functions: parking, dimmer, head, turn
  - Bulbs included
  - Connecteur: C6 built-in

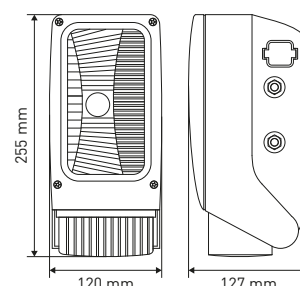

- REF 103TA4575** – Bulb: BA9S 12V 4W  
**REF 106TA4862** – Bulb: BA15S 12V 21W  
**REF 106TA4825** – Bulb: H4 12V 60/55W  
**REF 103TA4577** – Bulb: BA9S 24V 4W  
**REF 163TA8590** – Bulb: BA15S 24V 21W  
**REF 163TA8595** – Bulb: H4 24V 70/75W  
**REF 148TA4999** – Replacement lens headlight

**E-approved**



- REF 151TA3274** – 12V LH  
**REF 151TA3275** – 12V RH
- Technology: halogen/incandescent
  - Center distance: 200 mm
  - Functions: parking, dimmer, head, turn
  - Bulbs included
  - Connector: D6 built-in

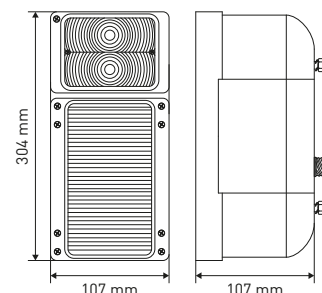

- REF 115TA4602** – Bulb: BA15S 12V 5W  
**REF 100TA2215** – Bulb: BA15S 12V 21W  
**REF 100TA2104** – Bulb: H4 12V 60/55W

**E-approved**





## FRONT DRIVING LIGHTS

**REF 151TA3307** – 12V LH

**REF 151TA3308** – 12V RH

- Technology: halogen/incandescent
- Mounting center distance: 60 mm
- Functions: parking, dimmer, turn
- Bulbs included
- Connector: C6 built-in

**REF 103TA4670** – Bulb: R2 12V 45/40W

**REF 122TA9116** – Bulb: BA9S 12V 4W

**REF 100TA2215** – Bulb: BA15S 12V 21W

**REF 151TA3309** – Mirror and lens

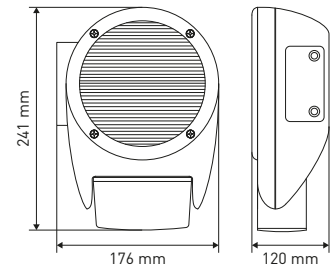

**REF 151TA3158**

- Technology: halogen/incandescent
- Mounting: pedestal
- 12–24V
- Functions: parking, dimmer, head
- Bulbs not included

**REF 103TA4575** – Bulb: BA9S 12V 4W

**REF 103TA4530** – Bulb: H4 12V 60/55W

**REF 100TA2165** – Bulb: BA9S 24V 4W

**REF 100TA2105** – Bulb: H4 24V 75/70W

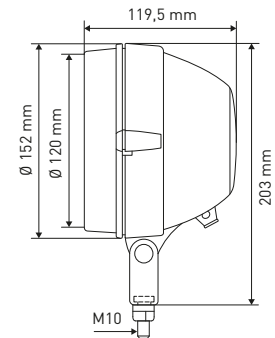

**E-approved**

**REF 151TA3215**

- Technology: halogen/incandescent
- Mounting: pedestal
- 12–24V
- Functions: parking, dimmer, head
- Bulbs not included

**REF 103TA4575** – Bulb: BA9S 12V 4W

**REF 103TA4530** – Bulb: H4 12V 60/55W

**REF 100TA2165** – Bulb: BA9S 24V 4W

**REF 100TA2105** – Bulb: H4 24V 75/70W

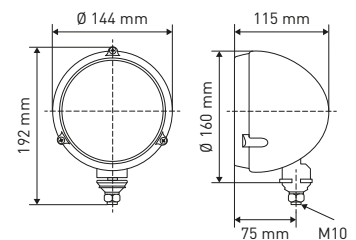

**E-approved**





## FRONT DRIVING LIGHTS

### REF [152TA2475](#)

- Technology: halogen
- Mounting: pedestal
- 12-24V
- IP5K4K
- Bulb not included

REF [103TA4530](#) – Bulb: H4 12V 60/55W

REF [100TA2105](#) – Bulb: H4 24V 75/70W

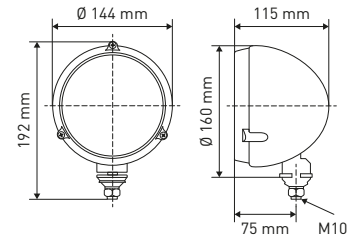

**E-approved**

- REF [151TA3395](#) – 12V LH blue
- REF [151TA3396](#) – 12V RH blue
- REF [151TA3397](#) – 12V LH red
- REF [151TA3398](#) – 12V RH red
- REF [151TA3399](#) – 12V LH black
- REF [151TA3400](#) – 12V RH black
- REF [151TA3401](#) – 12V LH white
- REF [151TA3402](#) – 12V RH white

- Technology: incandescent
- Mounting: pedestal
- Wire length: 65 mm
- Functions: dimmer, head
- Bulb included

REF [122TA9136](#) – Bulb: P22D 12V 50/40W

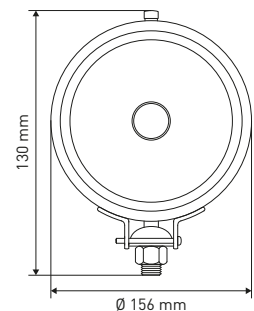
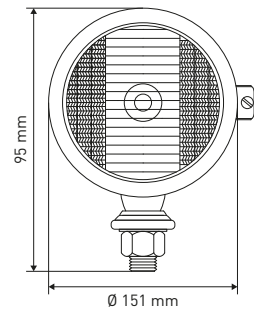

### REF [152TA2478](#) – 24V

- Technology: halogen
- Mounting: pedestal
- Functions: dimmer, head
- Bulb included

REF [100TA2105](#) – Bulb: H4 24V 75/70W



**E-approved**



## FRONT DRIVING LIGHTS

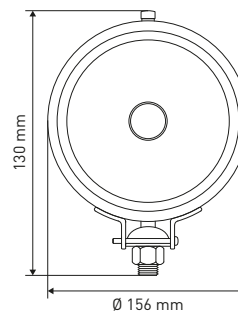

### **REF 152TA2482**

- Technology: halogen
- Mounting: pedestal
- Functions: dimmer, head
- 12-24V
- IP54
- Bulb not included

**REF 103TA4530** – Bulb: H4 12V 60/55W

**REF 100TA2105** – Bulb: H4 24V 75/70W

**E-approved**





# INDICATOR LIGHTS



## NICE TO KNOW – INDICATOR LIGHTS



Indicator lights increase the safety: they warn the environment for the direction of movement of the vehicle and draw the attention on any terrain.

Indicator lights are available in different shapes, sizes and dimensions. We can also supply combination lights with indicator lights and a continuously lit marker light. In addition, there are also 'two-sided illumination' indicator lights.



## BUILT-IN TURN SIGNAL LIGHTS



- REF **151TA4008** - 12V LH
- REF **151TA4009** - 12V RH
- Technology: LED
- Wire length: 315 mm
- Built-in
- Used for Hyster and Yale
- Connector: H3

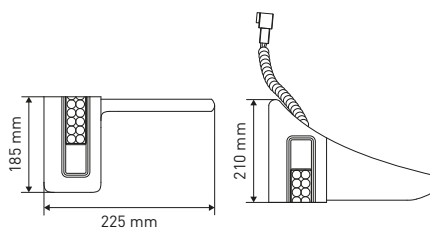

**TOTAL SOURCE**<sup>®</sup>



## STANDARD TURN SIGNAL LIGHTS

### REF 151TA4006

- Technology: incandescent
- Mounting: 2 screws
- Center distance: 28 mm
- 12V
- Bulb not included

REF 103TA4541 – Bulb: SV8.5-8 12V 18W

REF 150TA3789 – Replacement lens amber

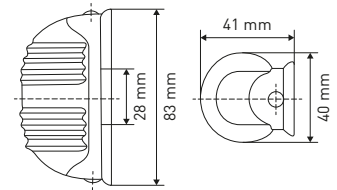

### REF 151TA3959

- Technology: incandescent
- Mounting: 2 screws
- Center distance: 80 mm
- 12V
- Bulb not included

REF 106TA4830 – Bulb: SV 8.5-8 12V 5W

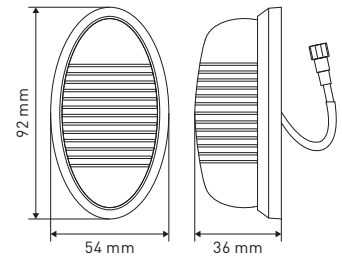

E-approved

**TOTAL SOURCE®**

### REF 151TA3960 – 12V

- Technology: incandescent
- Mounting: 2 screws
- Center distance: 69 mm
- Wire length: 350 mm
- Bulb included
- Connector: B2

REF 103TA4538 – Bulb: SV 8,5-8 12V 10W

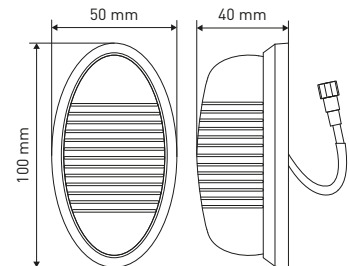

**TOTAL SOURCE®**

### REF 151TA3976 – 12V

### REF 151TA3977 – 48V

- Technology: incandescent
- Mounting: 2 screws
- Center distance: 60 mm
- Wire length: 260 mm
- Bulb included
- Connector: 1 x A1, 1 x H1

REF 100TA2215 – Bulb: BA15S 12V 21W

REF 106TA4865 – Bulb: BA15S 48V 25W

REF 150TA1024 – Replacement lens

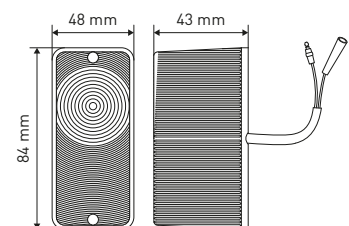

E-approved

**TOTAL SOURCE®**



## STANDARD TURN SIGNAL LIGHTS

### REF [151TA3979](#)

- Technology: incandescent
- Mounting: 2 screws
- Centre distance: 45 mm
- 12-24V
- Bulb not included

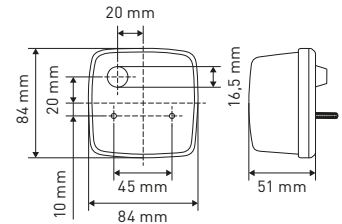

- REF [100TA2215](#) – Bulb: BA15S 12V 21W
- REF [103TA4603](#) – Bulb: BA15S 24V 21W
- REF [151TA3980](#) – Replacement lens amber



- REF [151TA3990](#) – 12V
- REF [151TA3991](#) – 24V
- Technology: incandescent
- Mounting: 2 screws
- Center distance: 80 mm
- Wire length: 400 mm
- Bulb included
- Connector: F1, 2 x G1

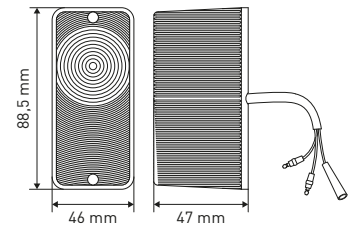

- REF [106TA4904](#) – Bulb: BAY15D 12V 23/8W
- REF [100TA2250](#) – Bulb: BAY15D 24V 25/10W



### REF [151TA3956](#)

- Technology: incandescent
- Mounting: 2 screws
- Centre distance: 48 mm
- 12-24V
- Bulb not included

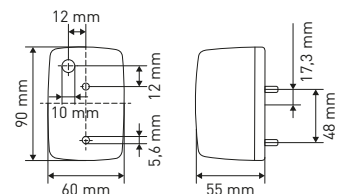

- REF [100TA2215](#) – Bulb: BA15S 12V 21W
- REF [103TA4603](#) – Bulb: BA15S 24V 21W
- REF [159TA9757](#) – Replacement lens



- REF [151TA3985](#) – 48V
- REF [151TA3986](#) – 56V
- Technology: incandescent
- Mounting: 2 screws
- Centre distance: 79 mm
- Wire length: 110 mm
- Bulb included
- Connector: 2 x G1

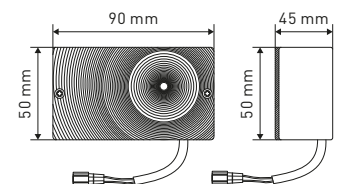

- REF [103TA4625](#) – Bulb: BAY15D 48V 25W
- REF [100TA2259](#) – Bulb: BAY15D 56V 25W
- REF [150TA2605](#) – Replacement lens





## STANDARD TURN SIGNAL LIGHTS

- REF 151TA3987** – 48V  
**REF 151TA3986** – 56V
- Technology: incandescent
  - Mounting: 2 screws
  - Centre distance: 79 mm
  - Wire length: 235 mm
  - Bulb included
  - Connector: 1 x D1, 1 x H1

- REF 103TA4625** – Bulb: BAY15D 48V 25W  
**REF 100TA2259** – Bulb: BAY15D 56V 25W  
**REF 150TA2605** – Replacement lens

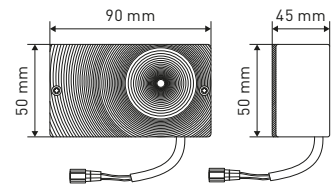

**TOTAL SOURCE**®

- REF 151TA3957**
- Technology: incandescent
  - Mounting: 2 screws
  - Center distance: 42 mm
  - 12–24V
  - Bulb not included

- REF 100TA2215** – Bulb: BA15S 12V 21W  
**REF 103TA4603** – Bulb: BA15S 24V 21W  
**REF 151TA3958** – Replacement lens

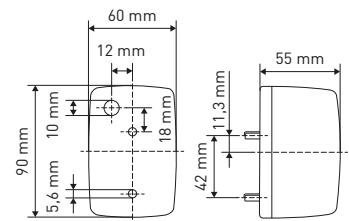

- REF 151TA3992** – 12V
- Technology: incandescent
  - Mounting: 2 screws
  - Center distance: 79 mm
  - Wire length: 140 mm
  - Bulb included
  - Connector: 1 x F1, 1 x G1

- REF 100TA2215** – Bulb: BA15S 12V 21W  
**REF 150TA1027** – Replacement lens

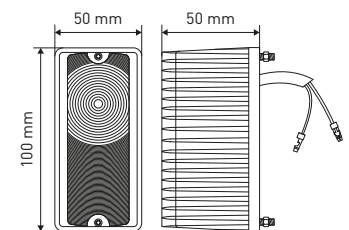

**TOTAL SOURCE**®

- REF 151TA3998** – 24V
- Technology: incandescent
  - Mounting: 2 screws
  - Center distance: 80 mm
  - Wire length: 120 mm
  - Bulb included
  - Connector: 3 x H1

- REF 106TA4875** – Bulb: BAY15D 24V 21/5W  
**REF 150TA1027** – Replacement lens front amber

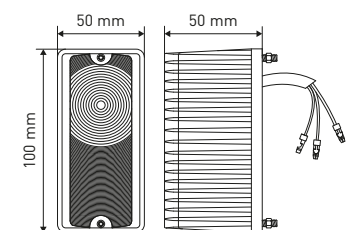

**TOTAL SOURCE**®





## STANDARD TURN SIGNAL LIGHTS

- REF 151TA3994** – 12V  
**REF 151TA3995** – 24V
- Technology: incandescent
  - Mounting: 2 screws
  - Center distance: 60 mm
  - Wire length: 260 mm
  - Bulb included
  - Connector: 1 x A1, 1 x H1

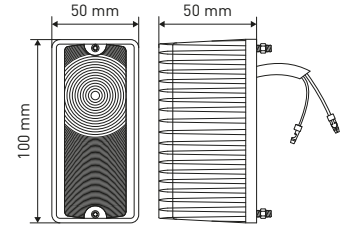
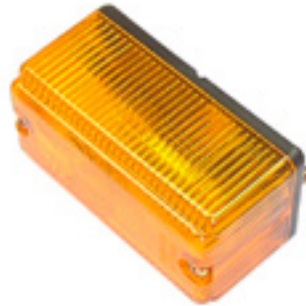

- REF 100TA2191** – Bulb: BA15S 12V 10W  
**REF 106TA4855** – Bulb: BA15S 24V 12W  
**REF 151TA3997** – Replacement lens amber  
**REF 150TA1259** – Replacement lens red

**TOTAL SOURCE®**

- REF 151TA3996** – 48V
- Technology: incandescent
  - Mounting: 2 screws
  - Center distance: 88 mm
  - Wire length: 150 mm
  - Bulb included
  - Connector: 1 x A1, 2 x G1

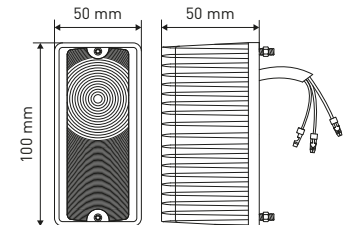
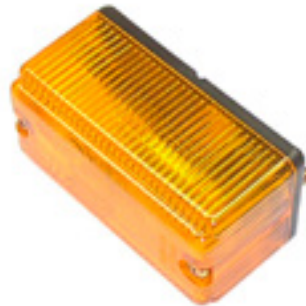

- REF 103TA4625** – Bulb: BAY15D 48V 25W  
**REF 151TA3997** – Replacement lens amber  
**REF 150TA1259** – Replacement lens red

**TOTAL SOURCE®**

- REF 151TA3993** – 24V
- Technology: incandescent
  - Mounting: 2 screws
  - Centre distance: 86 mm
  - Wire length: 140 mm
  - Functions: turn, marker
  - Bulb included
  - Connector: 3 x G1

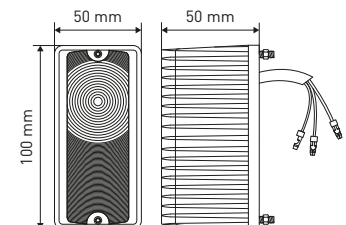

- REF 123TA7989** – Bulb: BAY15D 24V 21W  
**REF 150TA4734** – Replacement lens amber

**TOTAL SOURCE®**

- REF 151TA3999**
- Technology: incandescent
  - Mounting: 2 screws
  - Centre distance: 59 mm
  - 12–24V
  - Bulb not included

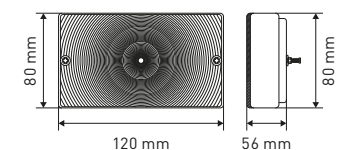

- REF 100TA2215** – Bulb: BA15S 12V 21W  
**REF 103TA4604** – Bulb: BA15S 24V 25W

**TOTAL SOURCE®**



## STANDARD TURN SIGNAL LIGHTS

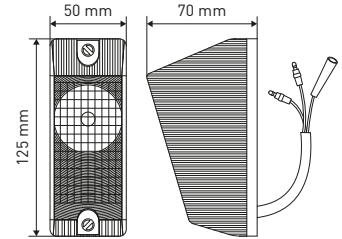

- REF 151TA4007** – 12V
- Technology: incandescent
  - Mounting: 2 screws
  - Center distance: 110 mm
  - Wire length: 185 mm
  - Functions: turn & marker
  - Bulb included
  - Connector: F1, 2 x G1

**REF 106TA4904** – Bulb: BAY15D 12V 23/8W

**TOTAL SOURCE**<sup>®</sup>

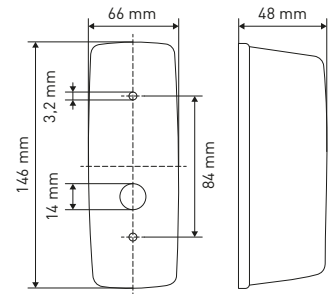

- REF 151TA4000** – LH  
**REF 151TA4001** – RH
- Technology: incandescent
  - Mounting: 2 screws
  - Center distance: 84 mm
  - 12–24V
  - Bulb not included

**REF 100TA2215** – Bulb: BA15S 12V 21W

**REF 103TA4603** – Bulb: BA15S 24V 21W



**E-approved**

- REF 151TA3961** – 12V  
**REF 151TA3962** – 24V  
**REF 151TA3963** – 48V
- Technology: incandescent
  - Mounting: 2 screws
  - Center distance: 140 mm
  - Wire length: 250 mm
  - Functions: turn, marker
  - Bulbs included
  - Connector: A1 & 2 x G1

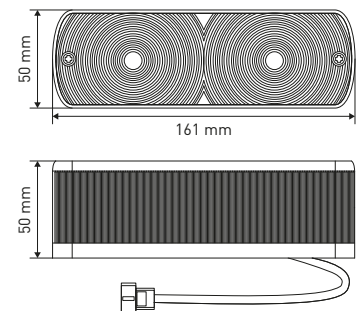

- REF 100TA2191** – Bulb: BA15S 12V 10W  
**REF 100TA2215** – Bulb: BA15S 12V 21W  
**REF 106TA4854** – Bulb: BA15S 24V 10W  
**REF 103TA4603** – Bulb: BA15S 24V 21W  
**REF 123TA7985** – Bulb: BA15S 48V 10W  
**REF 123TA7987** – Bulb: BA15S 48V 25W  
**REF 151TA3964** – Replacement lens

**TOTAL SOURCE**<sup>®</sup>



## STANDARD TURN SIGNAL LIGHTS

- REF 151TA3965** – 12V
- REF 151TA3966** – 24V
- Technology: incandescent
- Mounting: 2 screws
- Center distance: 90 mm
- Wire length: 240 mm
- Functions: turn, marker
- Bulbs included
- Connector: 2 x G1

- REF 103TA4586** – Bulb: BA15S 12V 10W
- REF 100TA2215** – Bulb: BA15S 12V 21W
- REF 123TA7984** – Bulb: BA15S 24V 10W
- REF 103TA4603** – Bulb: BA15S 24V 21 W
- REF 150TA3528** – Replacement lens

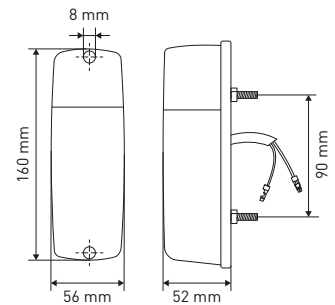

**TOTAL SOURCE®**

- REF 151TA4002** – 12V
- REF 151TA4003** – 24V
- REF 151TA4004** – 36V
- REF 151TA4005** – 48V
- Technology: incandescent
- Mounting: 2 screws
- Center distance: 149 mm
- Wire length: 300 mm
- Functions: turn, marker
- Bulbs included
- Connector: F3

- REF 100TA2191** – Bulb: BA15S 12V 10W
- REF 100TA2215** – Bulb: BA15S 12V 21W
- REF 123TA7984** – Bulb: BA15S 24V 10W
- REF 103TA4603** – Bulb: BA15S 24V 21 W
- REF 122TA9120** – Bulb: BAY15D 36V 8W
- REF 100TA2257** – Bulb: BAY15D 36V 25W
- REF 103TA4598** – Bulb: BAY15D 48V 10W
- REF 103TA4625** – Bulb: BAY15D 48V 25W

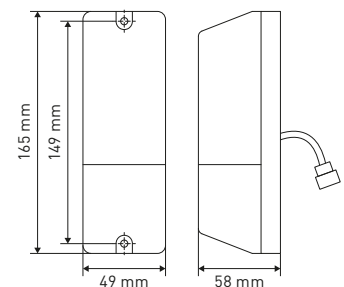

**TOTAL SOURCE®**



## TWO-SIDED TURN SIGNAL LIGHTS

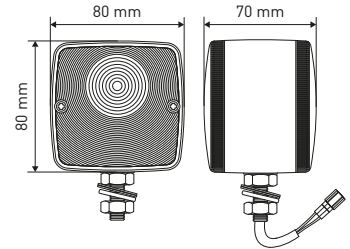

**REF 151TA3975** – 12V

- Technology: incandescent
- Mounting: single bolt M12
- Wire length: 385 mm
- Bulb included
- Connector: B2

**REF 123TA7983** – Bulb: BA15S 12V 10W

**REF 151TA3970** – Replacement lens amber

**REF 150TA5354** – Replacement lens rear red

**TOTAL SOURCE®**

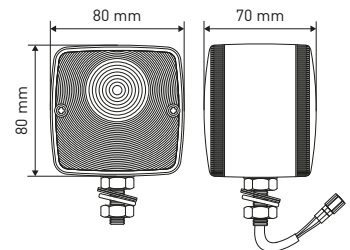

**REF 151TA3968** – 24V

- Technology: incandescent
- Mounting: single bolt M12
- Wire length: 220 mm
- Functions: turn, marker
- Bulbs included
- Connector: 2 x G1

**REF 106TA4848** – Bulb: BA9S 24V 5W

**REF 103TA4603** – Bulb: BA15S 24V 21W

**REF 151TA3969** – Replacement lens front amber

**REF 151TA3970** – Replacement lens rear amber

**TOTAL SOURCE®**

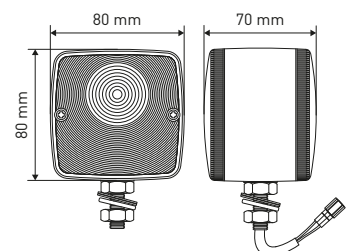

**REF 151TA3967** – 12V

**REF 152TA8902** – 24V

- Technology: incandescent
- Mounting: single bolt M12
- Wire length: 220 mm
- Functions: turn, marker
- Bulbs included
- Connector: H2

**REF 106TA4846** – Bulb: BA9S 12V 3W

**REF 100TA2215** – Bulb: BA15S 12V 21W

**REF 106TA4848** – Bulb: BA9S 24V 5W

**REF 103TA4603** – Bulb: BA15S 24V 21W

**REF 151TA3969** – Replacement lens front amber

**REF 151TA3970** – Replacement lens rear amber

**TOTAL SOURCE®**



## TWO-SIDED TURN SIGNAL LIGHTS

**REF 151TA3972** – 12V

**REF 151TA3973** – 24V

**REF 151TA3974** – 48V

- Technology: incandescent
- Mounting: single bolt M12
- Wire length: 220 mm
- Functions: turn, marker
- Bulbs included
- Connector: A3

**REF 106TA4846** – Bulb: BA9S 12V 3W

**REF 100TA2215** – Bulb: BA15S 12V 21W

**REF 106TA4848** – Bulb: BA9S 24V 5W

**REF 103TA4603** – Bulb: BA15S 24V 21W

**REF 103TA4581** – Bulb: BA9S 48V 5W

**REF 123TA7987** – Bulb: BA15S 48V 25W

**REF 151TA3969** – Replacement lens front amber

**REF 151TA3970** – Replacement lens rear amber

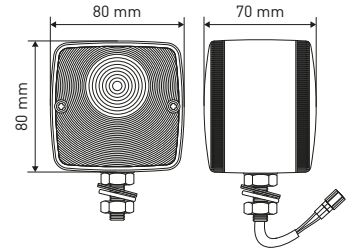

**TOTAL SOURCE®**

**REF 151TA3971** – 48V

- Technology: incandescent
- Mounting: single bolt M12
- Wire length: 260 mm
- Functions: turn, marker
- Bulbs included
- Connector: A3

**REF 103TA4581** – Bulb: BA9S 48V 5W

**REF 151TA3978** – Bulb: BA15S 48V 25W

**REF 151TA3969** – Replacement lens front amber

**REF 106TA1328** – Replacement lens rear amber

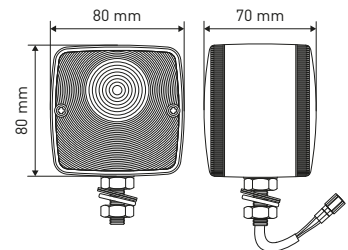

**TOTAL SOURCE®**

**REF 151TA3981** – 12V

**REF 148TA4167** – 24V

- Technology: incandescent
- Mounting: single bolt M12
- Wire length: 370 mm
- Functions: turn, marker
- Bulbs included
- Connector: 3W2RMBHB

**REF 100TA2191** – Bulb: BA15S 12V 10W

**REF 100TA2215** – Bulb: BA15S 12V 21W

**REF 106TA1279** – Bulb: BA15S 24V 10W

**REF 103TA4603** – Bulb: BA15S 24V 21W

**REF 150TA2579** – Replacement lens front

**REF 150TA2580** – Replacement lens rear

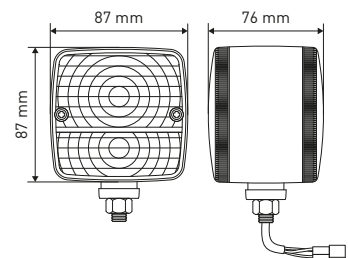

**TOTAL SOURCE®**



## TWO-SIDED TURN SIGNAL LIGHTS

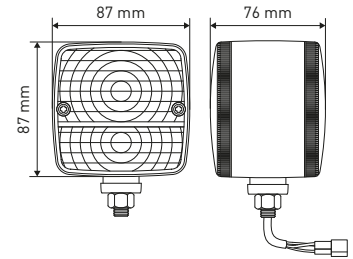

- REF 151TA3984** – 12V
- Technology: incandescent
  - Mounting: single bolt M12
  - Wire length: 380 mm
  - Bulbs included
  - Connector: 1 x F1, 2 x G1

- REF 103TA4596** – Bulb: BA15S 12V 10W  
**REF 100TA2215** – Bulb: BA15S 12V 21W  
**REF 150TA2579** – Replacement lens front  
**REF 150TA2580** – Replacement lens rear

**TOTAL SOURCE®**

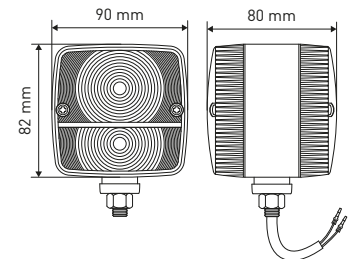
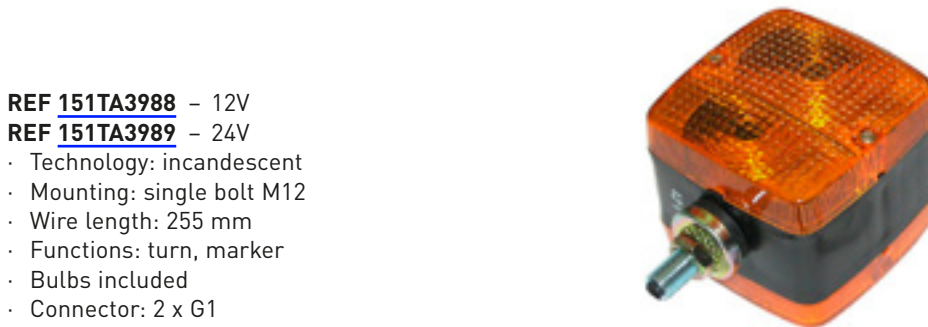

- REF 151TA3988** – 12V  
**REF 151TA3989** – 24V
- Technology: incandescent
  - Mounting: single bolt M12
  - Wire length: 255 mm
  - Functions: turn, marker
  - Bulbs included
  - Connector: 2 x G1

- REF 100TA2191** – Bulb: BA15S 12V 10W  
**REF 122TA9113** – Bulb: BA15S 12V 21W  
**REF 106TA4854** – Bulb: BA15S 24V 10W  
**REF 103TA4603** – Bulb: BA15S 24V 21W  
**REF 150TA2579** – Replacement lens front  
**REF 150TA2580** – Replacement lens rear

**TOTAL SOURCE®**

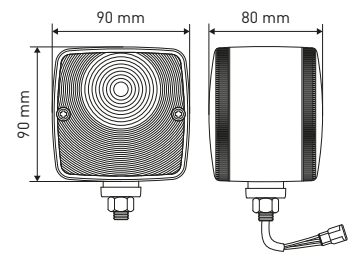

- REF 151TA3982** – 12V  
**REF 151TA3983** – 48V
- Technology: incandescent
  - Mounting: single bolt M12
  - Wire length: 375 mm
  - Functions: turn, marker
  - Bulbs included
  - Connector: C3

- REF 103TA4585** – Bulb: BA15S 12V 5W  
**REF 122TA9113** – Bulb: BA15S 12V 21W  
**REF 131TA4767** – Bulb: BAY15D 48V 8W  
**REF 103TA4614** – Bulb: BA15D 48V 25W  
**REF 150TA2579** – Replacement lens front  
**REF 150TA2580** – Replacement lens rear

**TOTAL SOURCE®**



## STANDARD TURN SIGNAL LIGHTS

- REF 151TA3941** – 12V
- Technology: incandescent
  - Mounting: 2 screws
  - Center distance: 39 mm
  - Bulb not included

- REF 100TA2215** – Bulb: BA15S 12V 21W  
**REF 150TA5159** – Replacement lens

**E-approved**

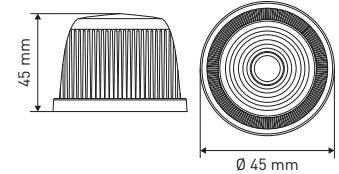

**TOTAL SOURCE®**

- REF 151TA3943** – Without bulb  
**REF 151TA3942** – 12V
- Technology: incandescent
  - Mounting: 2 screws
  - Center distance: 64 mm
  - Connector: B2 built-in

- REF 100TA2215** – Bulb: BA15S 12V 21W  
**REF 150TA4693** – Replacement lens rear amber

**E-approved**

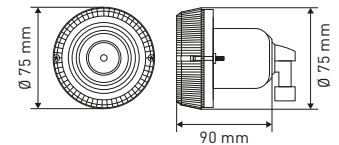

**COBO®**  
*group*

- REF 151TA3944**
- Technology: incandescent
  - Mounting: 2 screws
  - Center distance: 45 mm
  - 12V
  - Bulb not included

Red version, see page 126 (REF 151TA5982)  
 Green version, see page 155 (REF 151TA3265)

- REF 103TA4541** – Bulb: SV 8,5-8 12V 18W  
**REF 150TA3793** – Replacement lens  
**REF 151TA3945** – Replacement base

**E-approved**

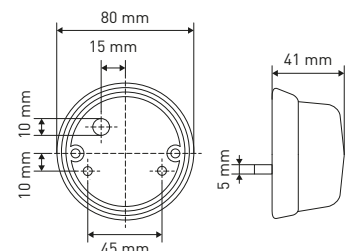

**TOTAL SOURCE®**



## TWO-SIDED TURN SIGNAL LIGHTS

**REF 151TA3946** – 12V

- Technology: incandescent
- Mounting: single bolt M12
- Wire length: 140 mm
- Functions: turn, marker
- Bulb included
- Connector: 1 x F1, 2 x G1

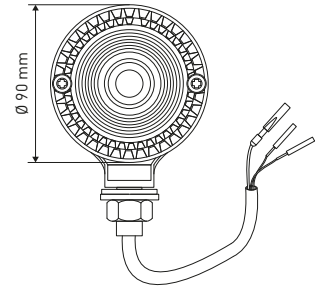

**REF 123TA7988** – Bulb: BAY15D 12V 21/5W

**TOTAL SOURCE®**

**REF 151TA3947** – 12V

- Technology: incandescent
- Mounting: single bolt M12
- Wire length: 240 mm
- Functions: turn, marker
- Bulbs included
- Connector: H2

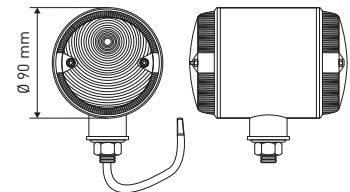

**REF 106TA4846** – Bulb: BA9S 12V 3W

**REF 100TA2215** – Bulb: BA15S 12V 21W

**REF 151TA3948** – Replacement lens rear amber

**TOTAL SOURCE®**

**REF 151TA3952** – 12V

**REF 151TA3953** – 24V

- Technology: incandescent
- Mounting: single bolt M12
- Wire length: 220 mm
- Functions: turn, marker
- Bulbs included
- Connector: 2 x G1

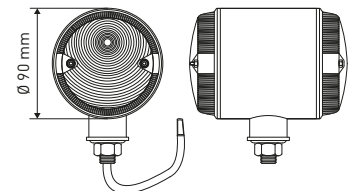

**REF 106TA4846** – Bulb: BA9S 12V 3W

**REF 100TA2215** – Bulb: BA15S 12V 21W

**REF 163TA8586** – Bulb: BA9S 24V 5W

**REF 103TA4603** – Bulb: BA15S 24V 21W

**REF 150TA2535** – Replacement lens rear

**TOTAL SOURCE®**

**REF 151TA3950** – 12V

- Technology: incandescent
- Mounting: single bolt M12
- Wire length: 350 mm
- Bulb included
- Connector: 2 x F1

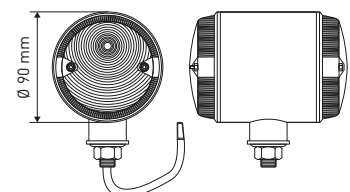

**REF 100TA2215** – Bulb: BA15S 12V 21W

**REF 151TA3951** – Replacement lens front

**REF 151TA3949** – Replacement lens rear amber

**TOTAL SOURCE®**





# **ROTATING/FLASHING BEACONS**



## NICE TO KNOW – ROTATING/FLASHING BEACONS



With rotating beacons and strobe lights, you warn the environment of your presence.

Rotating beacons and strobe lights exist in 3 different technologies: LED, xenon and halogen.

Depending on the selected technology, a distinction is made between rotating beacons and strobe lights:

- LED technology is used in both rotating beacons and strobe lights. The rotating beacon is created by means of a specific sequence of flashes in the light
- Xenon technology is restricted to the creation of flashes
- Halogen lights use a mirror to project the light beam around

Strobe lights are often bolted onto lift trucks, or attached via a magnet or suction cup. On tractors, a more commonly used method is a 'pole mounting'.

We also have some 'plug-and-play' models available. These are equipped with a magnetic mounting base and a 12V plug and can very easily be (un)installed.

All LED and xenon beacons are supplied including the LED module or Xenon tube. The voltage or voltage range is always mentioned beside the reference. Beacons with halogen or bulb technology are following the same logic. The voltage of the included bulb is mentioned beside the reference and otherwise the spare bulbs are shown below the technical data.

A small range of beacons for priority vehicles are also available. The use of rotating beacons on priority vehicles is restricted. The user must observe the regulations on this subject.



## LED FLASHING BEACONS

### REF 151TA3825

- Technology: LED
- Mounting: magnetic mount
- 3-way switch for flashing or steady-on operation
- IP65
- Requires 4 AA batteries (not included)

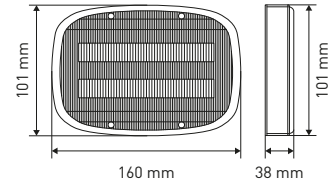

### REF 106TA9001 – 4 AA batteries

Portable

**TOTAL SOURCE**<sup>®</sup>

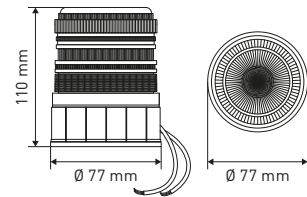

### REF 164TA1461 – 10-30V

- Technology: LED
- Mounting: 2 screws
- IP69K

**TOTAL SOURCE**<sup>®</sup>

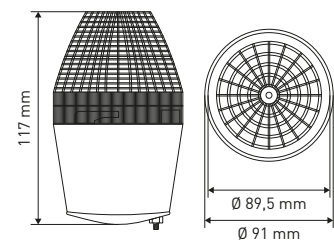

### REF 151TA3699 – 24-48V

- Technology: LED
- Mounting: 2 screws
- Center distance: 71 mm
- IP65
- Flash rate: 120 flashes/minute
- Connector: J3 built-in

**TOTAL SOURCE**<sup>®</sup>



## LED FLASHING BEACONS

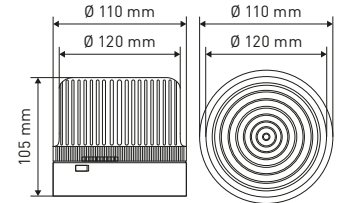

- REF 151TA3689** – 48V without cable  
**REF 151TA3690** – 48V with cable 250 mm
- Technology: LED
  - Mounting: 2 screws
  - Center distance: 90 mm
  - IP65
  - Flash rate: 120 flashes/minute

**TOTAL SOURCE®**

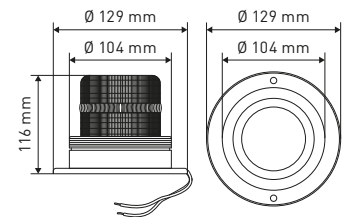

- REF 151TA3672** – 12–80V
- Technology: LED (3 pcs)
  - Mounting: 3 screws
  - Pitch circle: 115 mm
  - Wire length: 400 mm
  - IP65
  - Flash rate: 60 ± 90 flashes/minute
  - Economic version

**TOTAL SOURCE®**

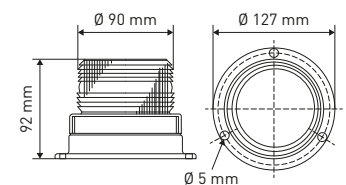

- REF 151TA3652** – 12–80V
- Technology: LED (6 pcs)
  - Mounting: 3 screws
  - Pitch circle: 115 mm
  - Wire length: 290 mm
  - IP65
  - Flash rate: 60 ± 10 flashes/minute
  - Lens not interchangeable

Made in USA

**METEORLITE®**



## LED FLASHING BEACONS

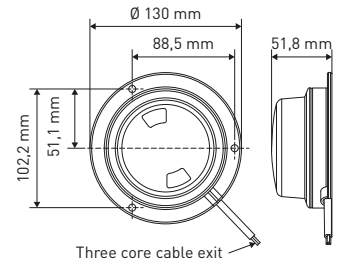

**REF 151TA3637** – 10–30V

- Technology: LED
- Mounting: 3 screws
- Pitch circle: 115 mm
- Length cable: 95 mm
- IP67
- 12 flash patterns
- Low profice

**TOTAL SOURCE®**

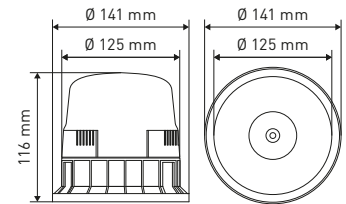

**REF 149TA7223** – 12–30V

- Technology: LED
- Mounting: magnetic suction cap
- Roll cable
- 12V car plug

**E-approved**

**TOTAL SOURCE®**

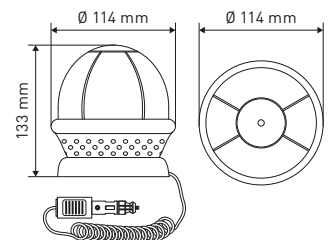

**REF 149TA5328** – 12–30V

- Technology: LED
- Mounting: magnetic suction cap
- 12V car plug

**E-approved**

**TOTAL SOURCE®**



## LED FLASHING BEACONS

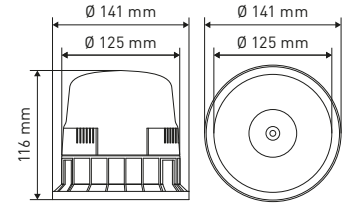

**REF 151TA3653** – 10-30V

- Technology: LED
- Mounting: 3 screws
- Pitch circle: 126 mm
- Wire length: 170 mm

**E-approved**

**TOTAL SOURCE®**

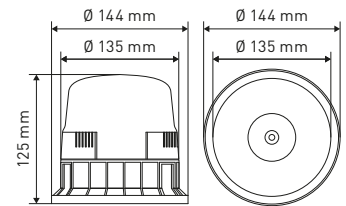

**REF 164TA6653** – 12-24V

- High-powered LED, 12W
- Technology: LED
- Mounting: 3 bolts
- IP66
- Polycarbonate shockproof lens
- ECE R10

**TOTAL SOURCE®**

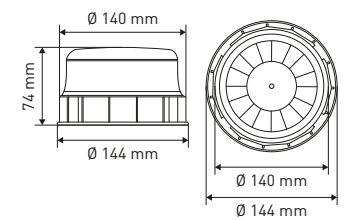

**REF 149TA5329** – 10-30V

- Technology: LED
- Mounting: 3 screws
- Pitch circle: 130 mm
- IP6K9K
- Low profile

**TOTAL SOURCE®**



## LED FLASHING BEACONS

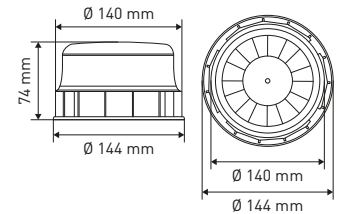

**REF 149TA5332** – 10-30V

- Technology: LED
- Mounting: magnetic
- 12V car plug

**TOTAL SOURCE®**

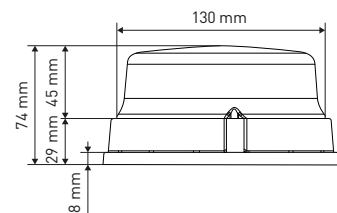

**REF 151TA3814** – 12-24V 3 bolt fixation

- Technology: LED
- Mounting: 3 screws
- Pitch circle: 130 mm
- Low profile

**TOTAL SOURCE®**

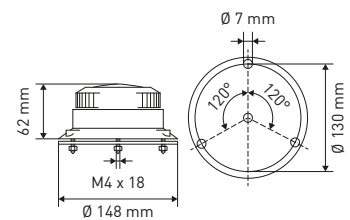

**REF 151TA3641** – 20-100V

- Technology: LED
- Mounting: 3 screws
- Pitch circle: 130 mm
- IP65
- Flash rate: 60 flashes/minute
- Hardware included
- Low profile



**CURTIS**



## LED FLASHING BEACONS

### REF **151TA3700** - 12-110V

- Technology: LED
- Mounting: 3 screws
- Pitch circle: 130 mm
- IP65
- Flash rate: 60-80 flashes/minute
- 4 flashing patterns

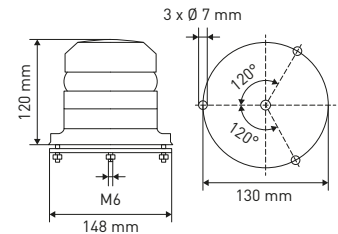

### REF **151TA3701** - Lens amber

### REF **164TA1466** - Support

Economic

**TOTAL SOURCE**®

### REF **151TA3714** - 10-100V

- Technology: LED
- Mounting: 3 screws
- Pitch circle: 130 mm
- Wire length: 350 mm
- IP54
- Flash rate: 50 flashes/minute
- 3 flashing patterns

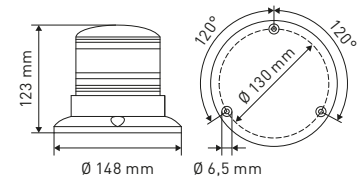

**SIRENA** s.p.a.

### REF **151TA3723** - 12-48V

- Technology: LED
- Mounting: 3 screws
- Pitch circle: 130 mm
- Wire length: 580 mm
- IP69K
- Flash rate: 65 flashes/minute

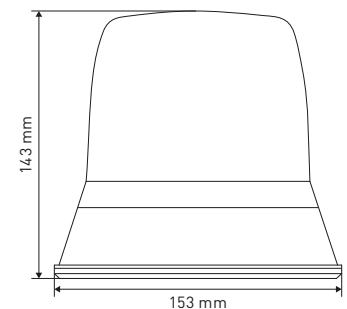

**TOTAL SOURCE**®





## LED FLASHING BEACONS

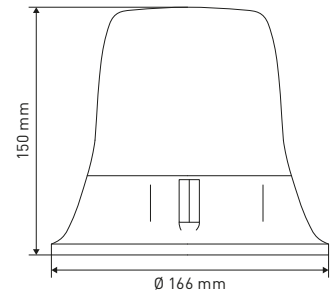

**REF 151TA3786** – 12-48V

- Technology: LED
- Mounting: magnetic mount
- Flash rate: 65 flashes/minute
- 12V car plug

**TOTAL SOURCE**®

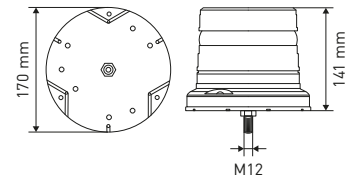

**REF 151TA3719** – 10-30V

- Technology: LED
- Mounting: 3 screws
- Pitch circle 130 mm
- Wire length: 630 mm
- IP54
- 11 flash patterns

**E-approved**

**TOTAL SOURCE**®

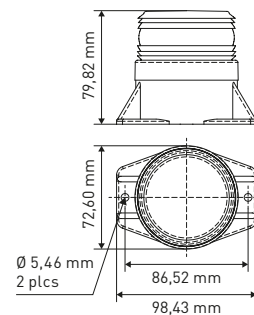

**REF 151TA3759** – 12-80V

- Technology: LED
- Mounting: 2 screws
- Center distance: 86 mm
- IP66
- Flash rate: 60 ± 10 flashes/minute
- Low profile

**REF 151TA3758** – Protection guard

**Made in USA**

**METEORLITE**®



## LED FLASHING BEACONS

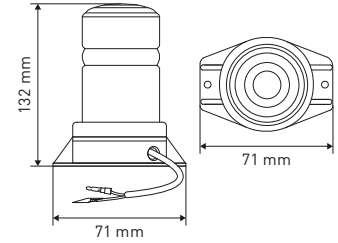

**REF 151TA3767** – 12-80V

- Technology: LED
- Mounting: 2 screws
- Center distance: 86 mm
- Wire length: 400 mm
- Connector: 1 x F1, 1 x G1
- Hardware included

**TOTAL SOURCE**®

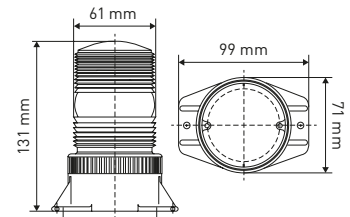

**REF 151TA3760** – 12-80V amber

- REF 151TA3761** – 12-80V blue version
- REF 151TA3762** – 12-80V clear version
- REF 141TA1473** – 12-80V green version
- REF 151TA3764** – 12-80V red version

- Technology: LED
- Mounting: 2 screws
- Center distance: 86 mm
- Wire length: 300 mm
- IP65
- Flash rate: 60 ± 10 flashes/minute

E-approved

Made in USA

**METEORLITE**®

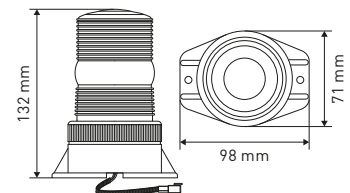

**REF 151TA3768** – 12-80V

- Technology: LED
- Mounting: 2 screws
- Center distance: 86 mm
- Wire length: 410 mm
- IP65
- Flash rate: 60 flashes/minute
- Connector: 2 x I2

Made in USA

**METEORLITE**®



## LED FLASHING & ROTATING BEACON

### REF 151TA3782 – Batteries

- Technology: LED
- Mounting:
  - magnetic mount
  - adapter plugs
  - suction pads
  - extra screws
- Wire length: 1520 mm
- IP66
- Flash rate: 60 flashes/minute
- Included:
  - car 12–24V DC charger
  - domestic 100–240V AC
  - 6 rechargeable AA batteries

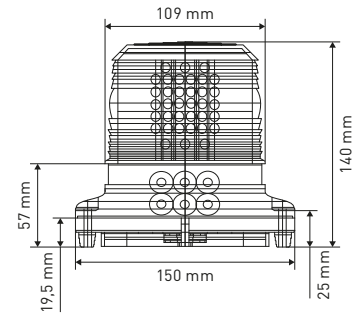

**TOTAL SOURCE®**

## XENON FLASHING BEACONS

### REF 151TA3823 – 24V

- Technology: xenon
- Mounting: 2 screws
- Center distance: 130 mm
- Wire length: 450 mm
- Flash tube not replaceable
- Connector: E3

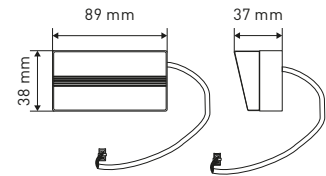

**TOTAL SOURCE®**

### REF 151TA3824 – 12–110V

- Technology: xenon
- Mounting: 2 screws
- Wire length: 215 mm
- Nominuteal power: ± 3W
- IP66
- 72 flashes/minute
- Flash tube included

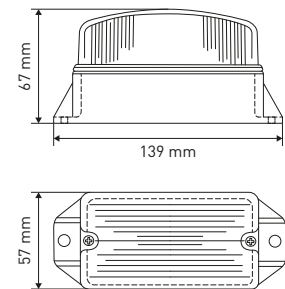

### REF 151TA2306 – Lens amber

### REF 106TA9146 – Protection guard

### REF 106TA9126 – Flash tube

**TOTAL SOURCE®**



## XENON FLASHING BEACONS

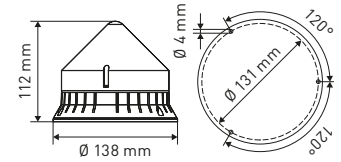

**REF 151TA3650** – 10–100V

- Technology: xenon
- Mounting: 3 screws
- Pitch circle: 130 mm
- IP54
- Flash tube not replaceable
- Low profile

**REF 151TA3649** – Lens amber

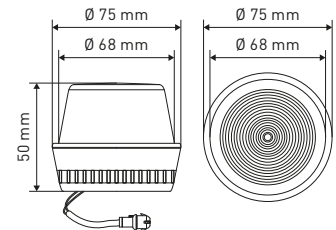

**REF 151TA3634** – 10–32V

- Technology: xenon
- Mounting: 2 screws
- Center distance: 45 mm
- Wire length: 530 mm
- IP67
- Flash tube included
- Connector: C2



**CURTIS**

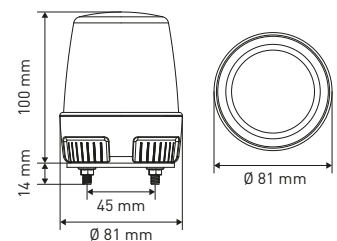

**REF 151TA3675** – 10–100V without connector

**REF 151TA3676** – 10–100V

- Technology: xenon
- Mounting: 2 screws
- Center distance: 45 mm
- Wire length: 460 mm
- IP67
- Flash tube included
- Connector: M2
- Used on Haulotte





## XENON FLASHING BEACONS

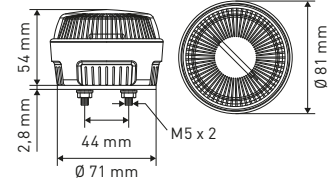

**REF 151TA3640** – 10–100V

- Technology: xenon
- Mounting: 2 screws
- Center distance: 50 mm
- Wire length: 400 mm
- IP67
- Flash tube included

**TOTAL SOURCE®**

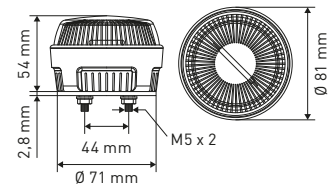

**REF 151TA3635** – 10–100V white  
**REF 151TA3636** – 10–100V amber

- Technology: xenon
- Mounting: 2 screws
- Center distance: 45 mm
- Wire length: 450 mm
- IP67
- Flash tube included

**TOTAL SOURCE®**

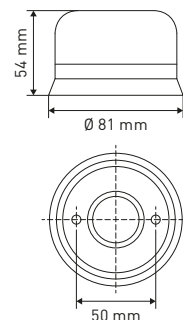

**REF 151TA3638** – 12–24V

- Technology: xenon
- Mounting: 2 screws
- Center distance: 50 mm
- IP65
- Flash tube not replaceable

**TOTAL SOURCE®**



## XENON FLASHING BEACONS

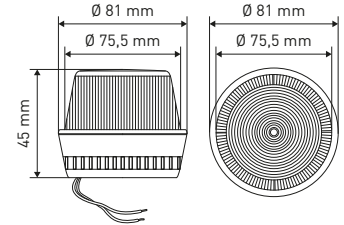

**REF 151TA3639** – 12-24V

- Technology: xenon
- Mounting: 2 screws
- Center distance: 45 mm
- Wire length: 475 mm
- IP67

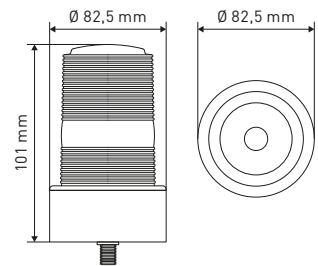

**REF 151TA3681** – 10-30V

- Technology: xenon
- Mounting: 3 screws
- Pitch circle: 49 mm
- Wire length: 365 mm
- IP67
- Connector: J2

**REF 151TA3683** – Lens  
**REF 151TA3682** – Flash tube

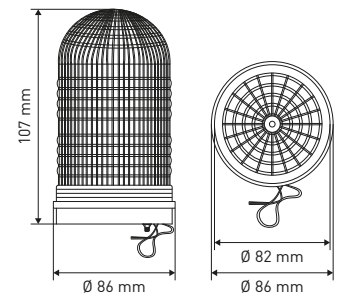

**REF 151TA3684** – 12-24V

- Technology: xenon
- Mounting: 3 screws
- Pitch circle: 45 mm
- Wire length: 340 mm
- Flash tube not replaceable





## XENON FLASHING BEACONS

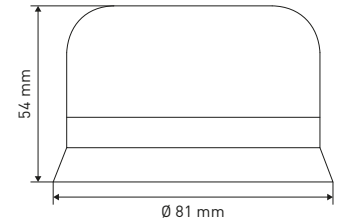

- REF 151TA3644** – 9–60V
- Technology: xenon
  - Mounting: central hole
  - IP65
  - Flash tube not replaceable

**TOTAL SOURCE®**

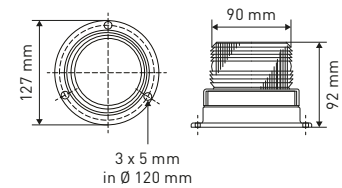

- REF 151TA3670** – 12–72V
- Technology: xenon
  - Mounting: 3 screws
  - Pitch circle: 115 mm
  - Wire length: 160 mm
  - IP54
  - Flash rate: 60 ± 10 flashes/minute
  - Connector: C2

- REF 106TA9126** – Flash tube  
**REF 111TA3637** – Flash tube 240V AC

**TOTAL SOURCE®**

- REF 151TA3677** – 12–110V amber  
**REF 151TA3679** – 12–110V green  
**REF 151TA3678** – 12–110V red  
**REF 106TA9123** – 12–110V blue  
**REF 106TA9124** – 12–110V clear
- Technology: xenon
  - Mounting: 3 screws
  - Pitch circle: 115 mm
  - Wire length: 200 mm
  - IP66
  - Flash rate: 60 ± 10 flashes/minute

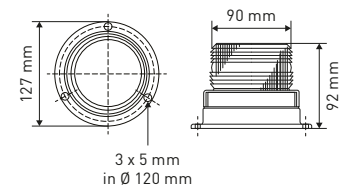

- REF 151TA3656** – Lens amber  
**REF 151TA3665** – Lens green  
**REF 151TA3678** – Lens red  
**REF 106TA9115** – Lens blue  
**REF 106TA9114** – Lens clear  
**REF 151TA3669** – Flash tube

**TOTAL SOURCE®**



## XENON FLASHING BEACONS



- REF 151TA3783** – 12-110V amber
- Technology: xenon
  - Mounting: magnetic mount
  - Wire length: 1100 mm
  - IP66
  - Flash rate: 36 flashes/minute
  - 12V car plug

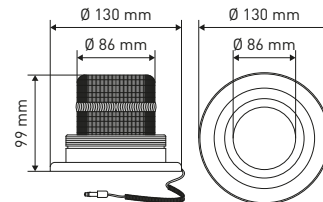

- REF 151TA3694** – Lens amber  
**REF 151TA2289** – Lens red  
**REF 150TA2426** – Lens blue  
**REF 151TA2290** – Lens white  
**REF 151TA3696** – Protection guard  
**REF 151TA3695** – Flash tube

**TOTAL SOURCE®**

Colour	12-110VDC	240AC
Amber	REF <a href="#">151TA3654</a>	REF <a href="#">151TA3655</a>
Blue	REF <a href="#">151TA3657</a>	REF <a href="#">151TA3658</a>
Clear	REF <a href="#">151TA3660</a>	REF <a href="#">151TA3661</a>
Green	REF <a href="#">151TA3663</a>	REF <a href="#">151TA3664</a>
Red	REF <a href="#">151TA3666</a>	REF <a href="#">151TA3667</a>



- Technology: xenon
- Mounting: 3 screws
- Pitch circle: 115 mm
- IP65
- Flash rate: 60 ± 10 flashes/minute

- REF 151TA3656** – Lens amber  
**REF 151TA3659** – Lens blue  
**REF 151TA3662** – Lens clear  
**REF 151TA3665** – Lens green  
**REF 151TA3668** – Lens red  
**REF 106TA9126** – Flash tube: 12-110V DC  
**REF 111TA3637** – Flash tube: 240V AC

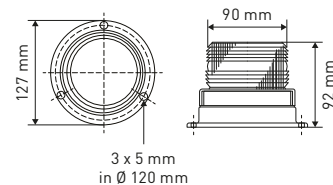

Made in USA

**METEORLITE®**





## XENON FLASHING BEACONS

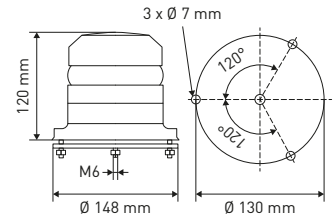

**REF 151TA3651** – 12-110V

- Technology: xenon
- Mounting: 3 screws
- Pitch circle: 118 mm
- IP54

**REF 160TA1088** – Flash tube



CURTIS

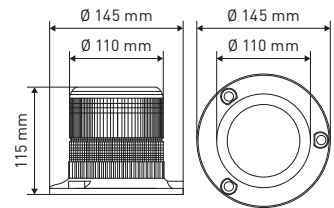

**REF 151TA3691** – 10-100V

- Technology: xenon
- Mounting: 3 screws
- Pitch circle 130 mm
- Wire length: 490 mm
- IP65
- Flash rate 75 flashes/minute

**TOTAL SOURCE**<sup>®</sup>

BRAND: DELTA DESIGN

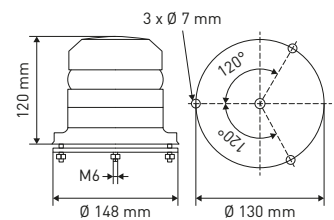

**REF 151TA3697** – 12-24V

- Technology: xenon
- Mounting: 3 screws
- Pitch circle: 130 mm
- Wire length: 505 mm
- IP69K
- Flash rate: 125 flashes/minute

**REF 151TA3698** – Flash tube

**TOTAL SOURCE**<sup>®</sup>

BRAND: ECCO



## XENON FLASHING BEACONS

- REF 151TA3702** – 12-100V with short cable
- REF 151TA3703** – 12-100V with cable 4100 mm
- REF 151TA3704** – 12-100V with connector used on Still and Linde

- Technology: xenon
- Mounting: 3 screws
- Pitch circle: 130 mm
- Wire length: 440 mm
- IP54

**REF 106TA9107** – Lens amber

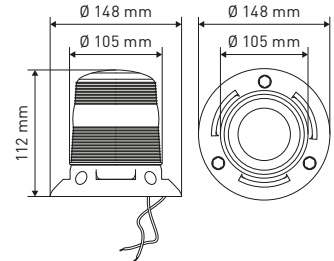

**TOTAL SOURCE®**

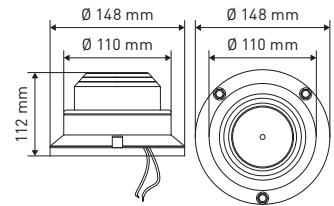

**REF 151TA3643** – 12-110V

- Technology: xenon
- Mounting: 3 screws
- Pitch circle: 130 mm
- Wire length: 330 mm
- IP66
- Flash tube not replaceable

**TOTAL SOURCE®**

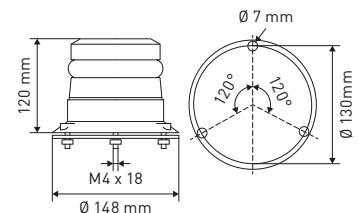

**REF 151TA3708** – 12- 80V

- Technology: xenon
- Mounting: 3 screws
- Pitch circle: 130 mm
- Wire length: 465 mm
- IP67
- Flash rate: 72 flashes/minute
- Flash tube not replaceable

**REF 151TA3701** – Lens amber

**REF 151TA3709** – Protection guard

**REF 151TA3710** – Mounting bracket



**CURTIS**



## XENON FLASHING BEACONS

### REF [151TA2424](#) – 10–120V

- Technology: xenon
- Mounting: 3 screws
- Pitch circle: 130 mm
- IP66
- Flash rate: 75 ± 10 flashes/minute
- Nominuteal power: ± 5W
- Flash tube included

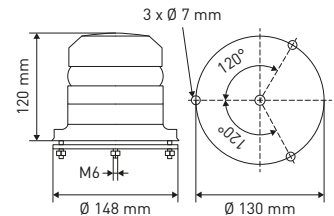

### REF [151TA3707](#) – Flash tube

**TOTAL SOURCE**<sup>®</sup>

### REF [151TA3705](#) – 10–110V

- Technology: xenon
- Mounting: 3 screws
- Pitch circle: 130 mm
- IP65
- Flash rate: 75 flashes/minute
- Nominuteal power: ± 7W
- Flash tube included

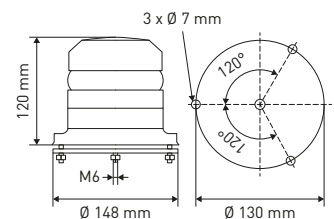

### REF [151TA3706](#) – Flash tube

**TOTAL SOURCE**<sup>®</sup>

### REF [151TA3712](#) – 10–110V

- Technology: xenon
- Mounting: 3 screws
- Pitch circle: 130 mm
- IP65
- Flash rate: 75 ± 10 flashes/minute
- Nominuteal power: ± 5W
- Flash Tube included

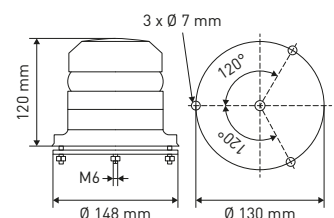

### REF [151TA3713](#) – Flash tube

**TOTAL SOURCE**<sup>®</sup>



## XENON FLASHING BEACONS

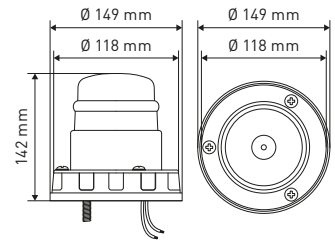

**REF 151TA3721** – 10-72V

- Technology: xenon
- Mounting: 3 screws
- Pitch circle: 128 mm
- Wire length: 100 mm
- IP56
- Flash tube included

**REF 151TA3722** – Flash tube

**TOTAL SOURCE®**

## FLASHING BEACON WITH AUDIBLE SOUND

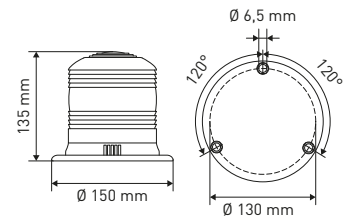

**REF 151TA3720** – 10-100V

- Technology: xenon
- Mounting: 3 screws
- Pitch circle: 130 mm
- IP20
- Lens not interchangeable
- Flash tube not replaceable

**SIRENA s.p.a.**



## XENON FLASHING BEACONS

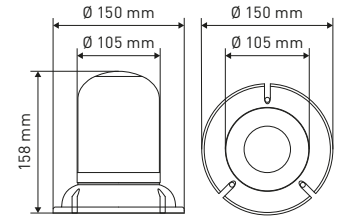

- REF 151TA3727** – 10-100V without cable  
**REF 151TA3728** – 10-100V with cable 1695 mm
- Technology: xenon
  - Mounting: 3 screws
  - Pitch circle: 130 mm
  - IP54
  - Flash rate: 60 ± 130 flashes/minute

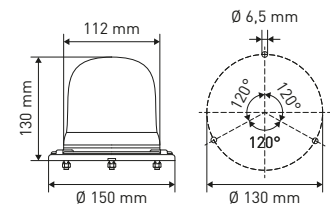

- REF 151TA3718** – 10-100V
- Technology: xenon
  - Mounting: 3 screws
  - Pitch circle 130 mm
  - Flash rate: 140 ± 10 flashes/minute

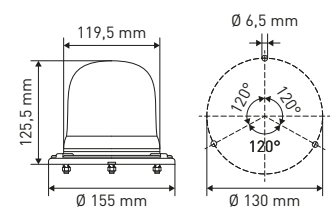

- REF 151TA3716** – 10-100V
- Technology: xenon
  - Mounting: 3 screws
  - Pitch circle 130 mm
  - IP54

- REF 151TA3717** – Flash tube





## DOUBLE FLASH XENON STROBE LIGHT

**REF 151TA3693** – 12–24V amber

**REF 151TA3694** – 36–48V amber

- Technology: xenon
- Mounting: 3 screws
- Pitch circle: 150 mm
- Wire length: 255 mm
- Flash tube included

**REF 151TA3694** – Lens amber

**REF 151TA2289** – Lens red

**REF 150TA2426** – Lens blue

**REF 151TA2290** – Lens white

**REF 151TA3695** – Flash tube

**REF 151TA3696** – Protection guard

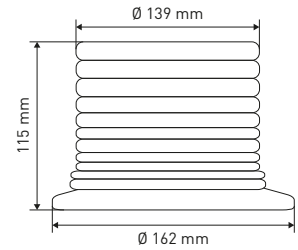

**TOTAL SOURCE**®

## XENON FLASHING BEACONS

**REF 151TA3692** – 12–24V

- Technology: xenon
- Mounting: 3 screws
- Pitch circle: 150 mm
- Wire length: 230 mm
- Flash tube included

**REF 151TA2288** – Flash tube

**REF 163TA8752** – Lens amber

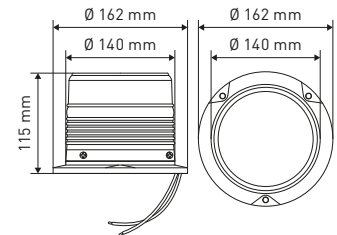

**TOTAL SOURCE**®

Double flash

**REF 151TA3725** – 12–24V

- Technology: xenon
- Mounting: 3 screws
- Wire length: 150 mm
- IP65
- Flash tube included

**REF 163TA8753** – Flash tube

**REF 150TA2420** – Lens amber

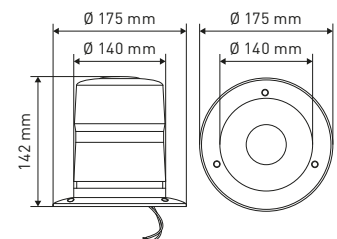

**METEORLITE**®



## XENON FLASHING BEACONS



**REF 151TA3755** – Wire length: 300 mm, Deutsch connector

**REF 151TA3765** – Wire length: 240 mm

- Technology: xenon
- Mounting: 2 screws
- Center distance: 86 mm
- 12–80V
- IP66
- Flash tube included

**REF 151TA3757** – Flash tube

**REF 151TA3756** – Lens amber

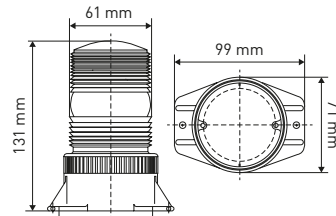

**TOTAL SOURCE®**



**REF 151TA3769** – Amber

**REF 151TA3770** – Blue

**REF 151TA3772** – Clear

**REF 151TA3774** – Green

**REF 151TA3776** – Red

- Technology: xenon
- Mounting: 2 screws
- Center distance: 86 mm
- Wire length: 250 mm
- 12–80V
- IP67
- Flash rate: 75 flashes/minute
- Flash tube included

**REF 151TA3756** – Lens amber

**REF 151TA3771** – Lens blue

**REF 151TA3773** – Lens clear

**REF 151TA3775** – Lens green

**REF 151TA3777** – Lens red

**REF 151TA3757** – Flash tube

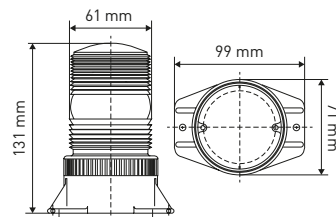

Made in USA

**METEORLITE®**



## XENON FLASHING BEACONS

### REF [151TA3779](#) – 12–80V

- Technology: xenon
- Mounting: 2 screws
- Center distance: 86 mm
- Wire length: 420 mm
- IP65
- Flash rate: 60 ± 80 flashes/minute
- Flash tube included

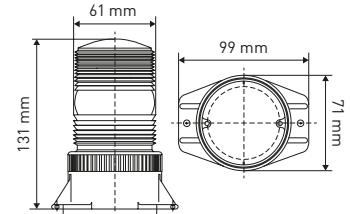

### REF [151TA3780](#) – Flash tube

**TOTAL SOURCE®**

### REF [151TA3752](#) – 10–100V with audible sound

- Technology: xenon
- Mounting: 4 screws
- Pitch circle: 130 mm
- IP55
- Flash tube included

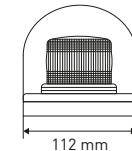
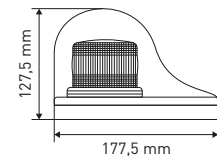

### REF [150TA5024](#) – Lens amber

### REF [151TA3753](#) – Flash tube

**SIRENA s.p.a.**

### REF [151TA3754](#) – 12–110V

- Technology: xenon
- Mounting: magnetic
- Wire length: 1060 mm
- 72 flashes/minute
- IP65
- Flash tube included
- 12V car plug

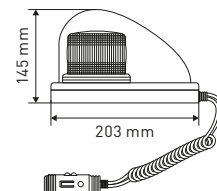

### REF [151TA3669](#) – Flash tube

**TOTAL SOURCE®**





## BULB FLASHING BEACONS

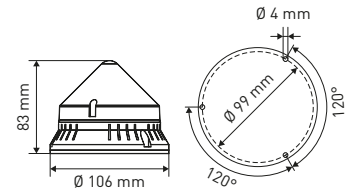

**REF 151TA3645** – 48V amber

- Technology: incandescent
- Mounting: 3 screws
- Pitch circle: 99 mm
- IP54
- Flash rate: 160 ± 30 flashes/minute
- Bulb included

**REF 119TA8919** – Bulb: BA15D 48V 10W

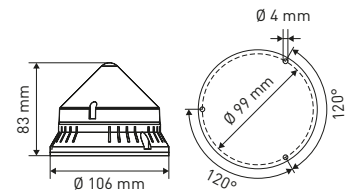

**REF 151TA3648** – 48V yellow

- Technology: incandescent
- Mounting: 3 screws
- Pitch circle: 99 mm
- IP54
- Flash rate: 160 ± 30 flashes/minute
- Bulb included

**E-approved**

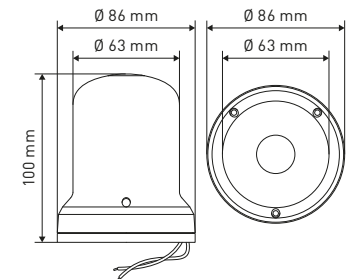

**REF 151TA3680** – 24V

- Technology: incandescent
- Mounting: 3 screws
- Pitch circle: 76 mm
- Wire length: 230 mm
- Bulb included

**REF 103TA4603** – Bulb: BA15S 24V 21W





## BULB STEADY BEACON

- REF 151TA3686** – Without bulb
- REF 151TA3687** – 24V with bulb
- REF 151TA3688** – 48V with bulb
- Technology: incandescent
- Mounting: 2 screws
- Center distance: 71 mm
- Wire length: 165 mm
- Connector: D2
- Uses flashing module of machine

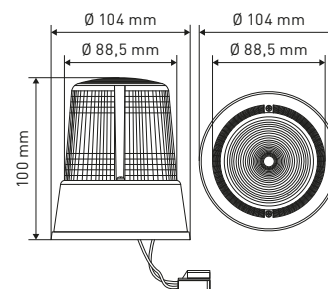

- REF 131TA4780** – Bulb: BA15D 24V 40W
- REF 106TA4902** – Bulb: BA15S 48V 40W

**TOTAL SOURCE®**

## HALOGEN ROTATING BEACONS

- REF 151TA3726** – 12V
- Technology: halogen
- Mounting: 3 screws
- Pitch circle: 75 mm
- IP54
- Bulb included

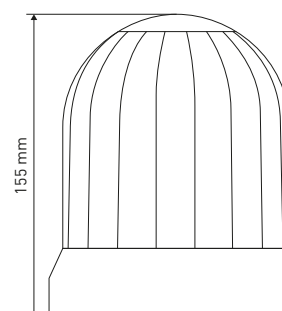

- REF 150TA5023** – Lens
- REF 123TA8005** – Bulb: H1 12V 55W

**E-approved**

**SIRENA s.p.a.**

- REF 151TA3732** – 24V
- Technology: halogen
- Mounting: 3 screws
- Pitch circle: 130 mm
- IP5K4K, IP9K
- Bulb included

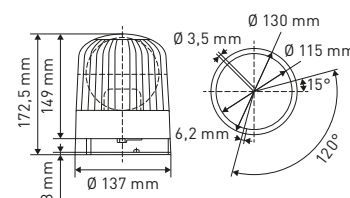

- REF 161TA6085** – Bulb: H1 24V 70W
- REF 150TA3844** – Lens amber

**E-approved**

**HELLA**



## HALOGEN ROTATING BEACONS

**REF 164TA1463** – 12-24V without bulb

**REF 149TA4911** – 12V with bulb

- Technology: halogen
- 12V
- Mounting: 3 screws
- Pitch circle: 130 mm

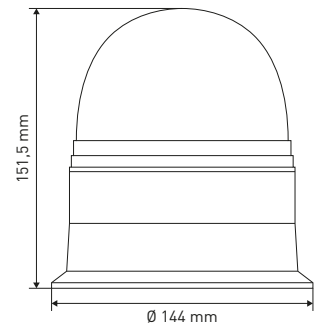

**REF 161TA5353** – Bulb: H1 12V 55W

**REF 161TA6085** – Bulb: H1 24V 70W

E-approved

**TOTAL SOURCE**®

**REF 164TA1464**

- Technology: halogen
- 12-24V
- Mounting: suction caps
- Bulb not included
- 12V car plug

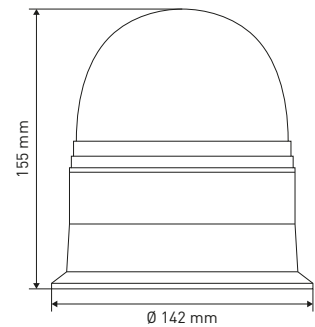

**REF 161TA5353** – Bulb: H1 12V 55W

**REF 161TA6085** – Bulb: H1 24V 70W

E-approved

**TOTAL SOURCE**®

**REF 151TA3739**

- Technology: halogen
- 12-24V
- Mounting: 3 screws
- Pitch circle: 130 mm
- Wire length: 260 mm
- IP54
- Rotation rate: 160 ± 20 rotations/minute
- Bulb not included

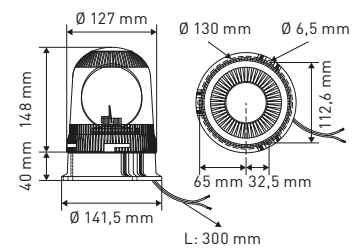

**REF 123TA8005** – Bulb: H1 12V 55W

**REF 123TA8006** – Bulb: H1 24V 70W

E-approved

**TOTAL SOURCE**®



## HALOGEN ROTATING BEACONS

### REF 151TA3735

- Type technologie: halogen
- 12-24V
- Mounting: pole mounting, 3 screws
- Pitch circle: 130 mm
- IP55
- Bulb not included

REF 123TA8005 – Bulb: H1 12V 55W

REF 123TA8006 – Bulb: H1 24V 70W

REF 150TA3148 – Lens

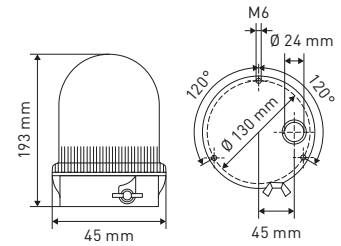

E-approved

**SIRENA** s.p.a.

## BULB ROTATING BEACON



REF 151TA3743 – Without bulb

REF 164TA7819 – 36V

REF 151TA3744 – 48V

REF 151TA3745 – 80V

- Technology: incandescent
- 12-80V
- Mounting: 3 screws
- Pitch circle: 130 mm
- IP54
- Rotation rate: 160 ± 30 rotations/minute

REF 106TA9127 – Lens amber

REF 106TA9128 – Lens blue

REF 106TA9129 – Lens green

REF 103TA4664 – Bulb: BA20S 36V 35W

REF 106TA9138 – Bulb: BA20S 48V 35W

REF 123TA8001 – Bulb: BA20S 80V 35W

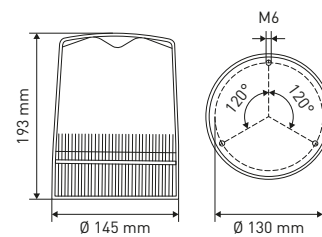

**SIRENA** s.p.a.



## HALOGEN ROTATING BEACONS

- REF 151TA3738** – without bulb
- REF 151TA3736** – 12V
- REF 151TA3737** – 24V
- Technology: halogen
- 12-24V
- Mounting: 3 screws
- Pitch circle: 130 mm
- IP54
- Rotation rate: 160 ± 30 rotations/minute

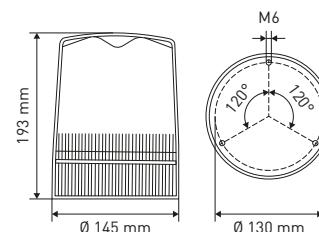

- REF 106TA9127** – Lens amber
- REF 106TA9128** – Lens blue
- REF 106TA9129** – Lens green
- REF 106TA9130** – Lens red
- REF 123TA8005** – Bulb: H1 12V 55W
- REF 123TA8006** – Bulb: H1 24V 70W

**E-approved**



- REF 151TA3715** – 24V
- Technology: halogen
- Mounting: 3 screws
- Pitch circle: 130 mm
- IP55
- Bulb included

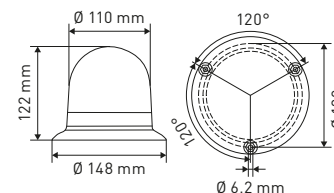

- REF 123TA8006** – Bulb: H1 24V 70W

**E-approved**



- REF 151TA3729** – Without bulb
- REF 151TA3730** – 12V
- REF 151TA3731** – 24V
- Type technologie: halogen
- Mounting: 3 screws
- Pitch circle: 130 mm
- IP54
- Rotation rate: 160 ± 30 rotations/minute

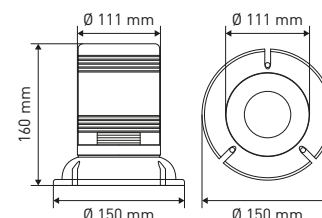

- REF 151TA3647** – Protection guard
- REF 151TA2281** – Support
- REF 161TA5353** – Bulb: H1 12V 55W
- REF 161TA6085** – Bulb: H1 24V 70W

**E-approved**





## HALOGEN ROTATING BEACONS

- REF 151TA3748** – 12V without cable
- REF 151TA3749** – 12V with cable
- Technology: halogen
- Mounting: 3 screws
- Pitch circle: 130 mm
- Wire length: 120 mm
- IP65
- Rotation rate: 180 ± 30 rotations/minute
- Bulb included

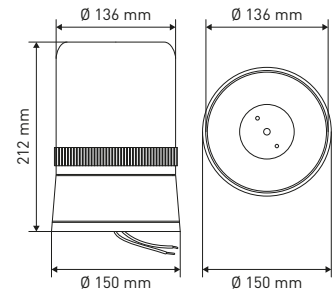

- REF 151TA3750** – Protection guard
- REF 151TA3751** – Lens amber
- REF 144TA5476** – Bulb: H1 12V 55W

**E-approved**

**TOTAL SOURCE®**

- REF 151TA3724** – 12V
- Technology: halogen
- Mounting: 3 screws
- Pitch circle: 130 mm
- Wire length: 100 mm
- IP54
- Rotation rate: 160 ± 30 rotations/minute
- Bulb included

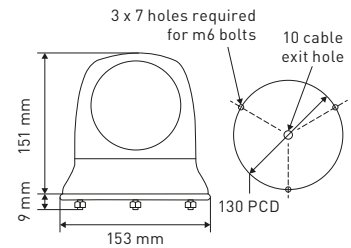

- REF 144TA5476** – Bulb: H1 12V 55W

**E-approved**

**TOTAL SOURCE®**

BRAND: BRITAX

- REF 151TA3733** – Without bulb
- REF 151TA3734** – 12V
- REF 149TA4303** – 24V
- Technology: halogen
- Mounting: 3 screws
- Pitch circle: 130 mm
- Wire length: 185 mm
- IP56
- Rotation rate: 180 rotations/minute
- Bulb not included

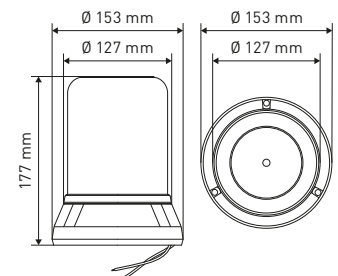

- REF 123TA8005** – Bulb: H1 12V 55W
- REF 123TA8006** – Bulb: H1 24V 70W

**E-approved**

**TOTAL SOURCE®**



## HALOGEN ROTATING BEACONS

### REF 151TA3787 – 12V

- Technology: halogen
- Mounting: magnetic mount
- Wire length: 550 mm
- IP54
- Rotation rate: 160 rotations/minute
- Bulb included
- 12V car plug

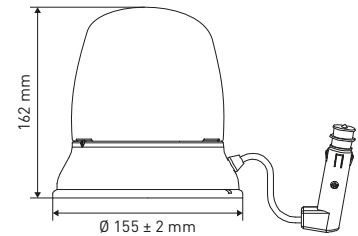

### REF 123TA8005 – Bulb: H1 12V 55W

**E-approved**

**TOTAL SOURCE®**  
BRAND: BRITAX

### REF 151TA3740 – 12V

### REF 151TA3741 – 24V

- Technology: halogen
- Mounting: 3 screws
- Pitch circle: 130 mm
- IP5K4K, IP9K
- Rotation rate: 160 rotations/minute
- Bulb included

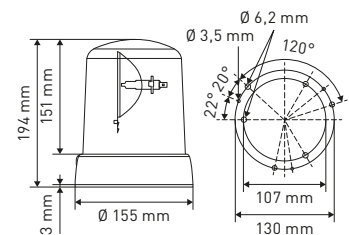

### REF 123TA8005 – Bulb: H1 12V 55W

### REF 123TA8006 – Bulb: H1 24V 70W

**E-approved**



### REF 151TA3742 – 24V

- Technology: halogen
- Mounting: 3 screws
- Pitch circle: 130 mm
- IP5K4K, IP9K
- Rotation rate: 160 rotations/minute
- Bulb included

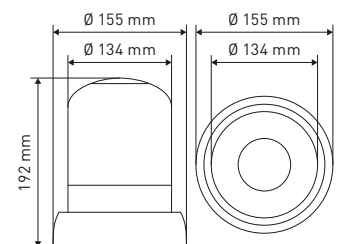

### REF 123TA8006 – Bulb: H1 24V 70W

**E-approved**





## BULB ROTATING BEACON

**REF 151TA3747** – 48V

- Technology: incandescent
- Mounting: 3 screws
- Pitch circle: 136 mm
- Wire length: 280 mm
- IP23
- Rotation rate: 140 ± 25 rotations/minute
- Bulb included

**REF 103TA4634** – Bulb: BA15D 48V 35W

**REF 150TA1314** – Lens amber

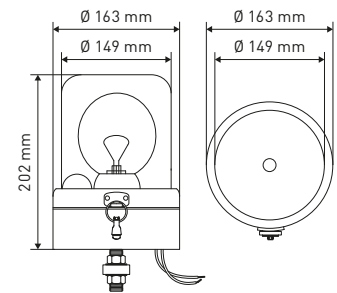

**TOTAL SOURCE**®

## HALOGEN ROTATING BEACONS

**REF 151TA3789** – Without bulb

**REF 151TA3788** – 12V

- Technology: halogen
- Mounting: magnetic mount
- Wire length: 550 mm
- IP56
- Rotation rate: 180 rotations/minute
- Bulb included
- 12V car plug

**REF 123TA8005** – Bulb: H1 12V 55W

**REF 151TA3790** – Lens amber

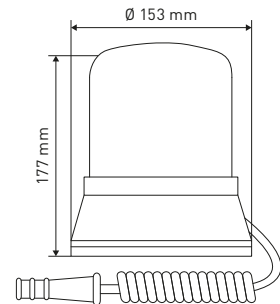

**TOTAL SOURCE**®

**E-approved**

**REF 151TA3785** – 12V

- Technology: halogen
- Mounting: magnetic mount and suction cap
- Wire length: 670 mm
- Bulb included
- 12V car plug

**REF 123TA8005** – Bulb: H1 12V 55W

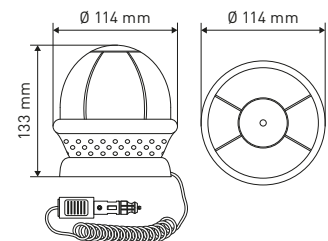

**TOTAL SOURCE**®

**E-approved**





## HALOGEN BEACONS

### REF 151TA3784

- Technology: halogen
- 12-24V
- Mounting: magnetic mount and suction cap
- Wire length: 650 mm
- IP65
- Bulb included
- 12V car plug

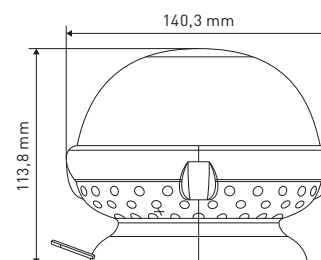

REF 151TA2311 – Bulb: BAY9S 12V 21W

REF 151TA2312 – Bulb: BAY9S 24V 21W

E-approved

**TOTAL SOURCE**<sup>®</sup>

### REF 151TA3791 – 12V

- Technology: halogen
- Mounting: magnetic mount
- Wire length: 650 mm
- IP54
- Rotation rate: 160 ± 30 rotations/minute
- Bulb included
- 12V car plug

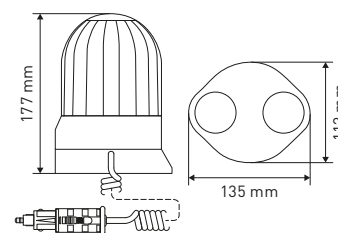

REF 123TA8005 – Bulb: H1 12V 55W

E-approved

**SIRENA** s.p.a.

## LED ROTATING BEACONS

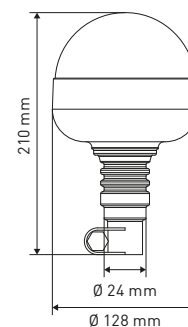

### REF 149TA2683 – 10-30V

- Technology: LED
- Mounting: pole mount
- 3 selectable flash patterns: rotating, double and quad flash

**TOTAL SOURCE**<sup>®</sup>



## LED ROTATING BEACONS

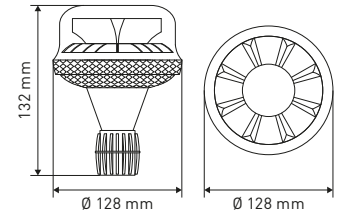

REF **149TA5331** – 10-30V

- Technology: LED
- Mounting: pole mount
- IP6K9K

**TOTAL SOURCE**<sup>®</sup>

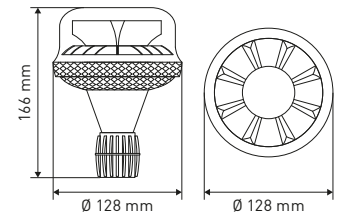

REF **149TA5303** – 10-30V

- Technology: LED
- Mounting: pole mount

E-approved

**TOTAL SOURCE**<sup>®</sup>

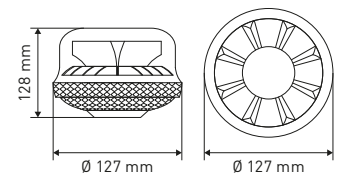

REF **164TA1465** – 10-30V

- Technology: LED
- Mounting: pole mount

E-approved

**TOTAL SOURCE**<sup>®</sup>



## LED FLASHING BEACONS

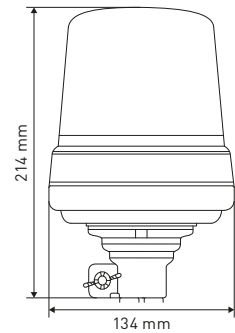

**REF 151TA3800** – 12-48V

- Technology: LED
- Mounting: pole mount
- IP69
- Flash rate: 65 flashes/minute

**TOTAL SOURCE**<sup>®</sup>

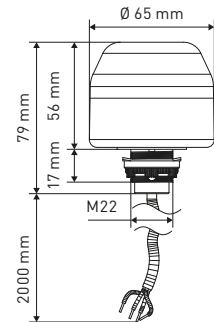

**REF 151TA3793** – 12V

- Technology: LED
- Mounting: on socket
- IP65
- Flash rate: 60 flashes/minute

**TOTAL SOURCE**<sup>®</sup>



## XENON FLASHING BEACONS

### REF 151TA3781 - 12-80V

- Technology: xenon
- Mounting: central bolt
- Wire length: 230 mm
- IP67
- Flash rate: 75 flashes/minute
- Flash tube included

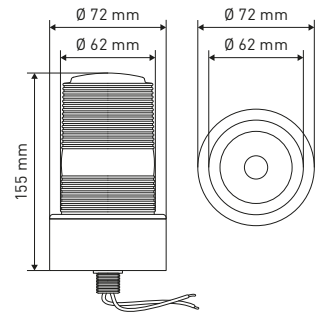

### REF 126TA6121 - Flash tube

Made in USA

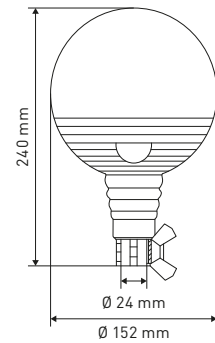

### REF 151TA3809 - 12V

- Technology: xenon
- Mounting: pole mount
- IP55
- Flash rate: 140 ± 10 flashes/minute

### REF 151TA3810 - Lens amber





## HALOGEN ROTATING BEACONS

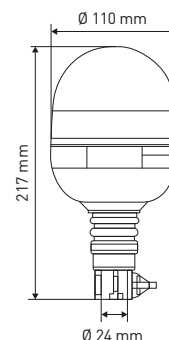

**REF 151TA3792** – 12V

- Technology: halogen
- Mounting: pole mount
- IP55
- Rotation rate: 160 ± 30 rotations/minute

**REF 123TA8005** – Bulb: H1 12V 55W

**TOTAL SOURCE**<sup>®</sup>

**REF 151TA3794** – Amber

- Technology: halogen
- 12–24V
- Mounting: central bolt M10
- Wire length: 160 mm
- IP56
- Rotation rate: 180 rotations/minute
- Bulb not included
- Connector: 1 x A1, 1 x G1

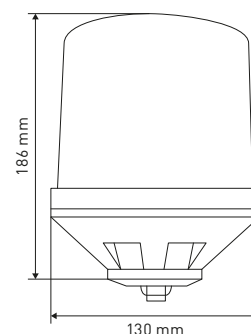

**REF 100TA2093** – Bulb: H1 12V 55W

**REF 123TA8006** – Bulb: H1 24V 70W

**REF 151TA3795** – Lens amber

**REF 151TA3796** – Lens green

E-approved

**TOTAL SOURCE**<sup>®</sup>

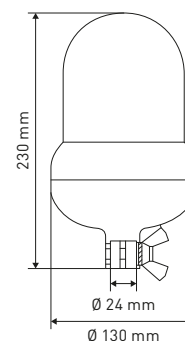

**REF 151TA3797** – 12V

- Technology: halogen
- Mounting: pole mount
- IP54
- Rotation rate: 160 rotations/minute
- Bulb included

**REF 123TA8005** – Bulb: H1 12V 55W

E-approved

**SIRENA** s.p.a.



## HALOGEN ROTATING BEACONS

### REF 151TA3802

- Technology: halogen
- Mounting: pole mount
- IP55
- Rotation rate: 160 rotations/minute
- 12-24V
- Bulb not included

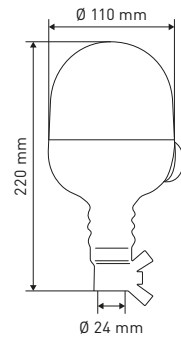

REF 123TA8005 – Bulb: H1 12V 55W

REF 123TA8006 – Bulb: H1 24V 70W



### REF 151TA3746 – 24V

- Technology: halogen
- Mounting: pole mount
- IP54
- Rotation rate: 160 ± 20 rotations/minute
- Bulb included

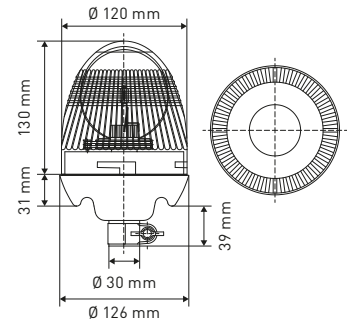

REF 161TA6085 – Bulb: H1 24V 70W

REF 150TA4721 – Lens amber

E-approved



REF 151TA3805 – 12V amber

REF 151TA3806 – 12V red

- Technology: halogen
- Mounting: pole mount
- IP54
- Rotation rate: 160 ± 20 rotations/minute
- Bulb included

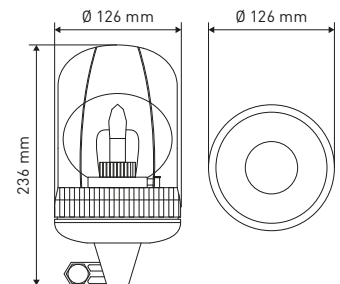

REF 123TA8005 – Bulb: H1 12V 55W

REF 151TA3807 – Lens amber

REF 150TA3214 – Lens red

E-approved





## HALOGEN ROTATING BEACONS

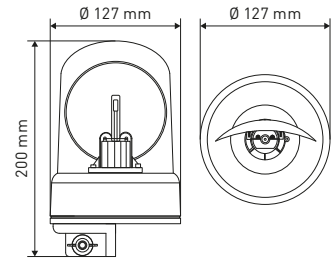

- REF 151TA3801** – 12V
- Technology: halogen
  - Mounting: pole mount
  - Bulb included

**REF 123TA8005** – Bulb: H1 12V 55W

**E-approved**

**TOTAL SOURCE®**

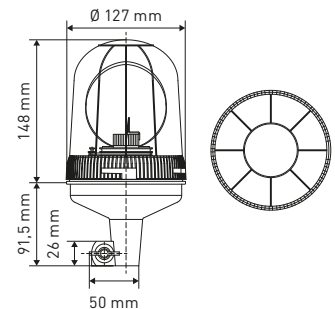

- REF 151TA3808**
- Technology: halogen
  - Mounting: pole mount
  - 12–24V
  - IP54
  - Rotation rate: 160 ± 20 rotations/minute
  - Bulb not included

**REF 161TA5353** – Bulb: H1 12V 55W

**REF 161TA6085** – Bulb: H1 24V 70W

**E-approved**

**TOTAL SOURCE®**

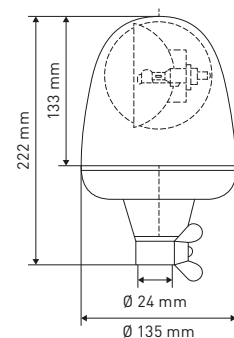

- REF 151TA3803** – 24V
- Technology: halogen
  - Mounting: pole mount
  - IP5K4K, IPX9K
  - Rotation rate: 160 rotations/minute
  - Bulb included

**REF 123TA8006** – Bulb: H1 24V 70W

**E-approved**





## HALOGEN ROTATING BEACONS

**REF 151TA3811** – Without bulb

**REF 151TA3812** – 12V

**REF 151TA3813** – 24V

- Technology: halogen
- Mounting: pole mount
- IP66
- Rotation rate: 160 ± 30 rotations/minute
- Flexible

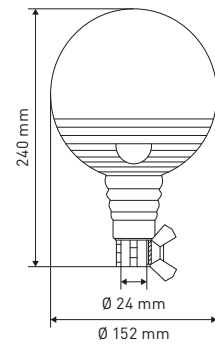

**REF 123TA8005** – Bulb: H1 12V 55W

**REF 123TA8006** – Bulb: H1 24V 70W

E-approved

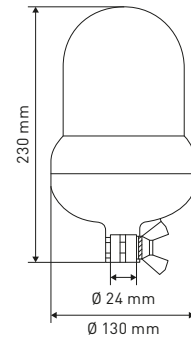

**REF 151TA3804** – 12V

- Technology: halogen
- Mounting: pole mount
- IP54
- Rotation rate: 160 rotations/minute
- Bulb included

**REF 123TA8005** – Bulb: H1 12V 55W

E-approved







## XENON FLASHING LIGHT BARS

### REF [151TA3821](#) – 12-24V

- Technology: xenon
- Mounting: magnetic mount
- Wire length: 755 mm
- IP54
- 12V car plug
- Flash rate: 75 ± 10 flashes/minute
- Flash tubes included

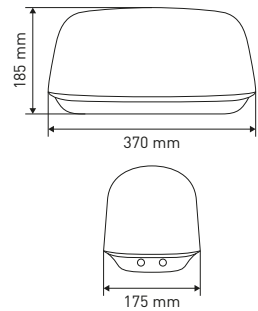

### REF [151TA3706](#) – Flash tube

**TOTAL SOURCE®**

### REF [151TA3818](#) – 12-24V

- Technology: xenon
- Mounting: magnetic mount
- Wire length: 755 mm
- IP54
- 12V car plug
- Flash rate: 75 ± 10 flashes/minute
- Flash tubes not replaceable

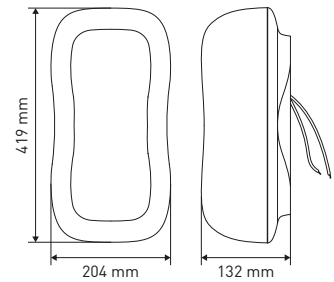

**TOTAL SOURCE®**



## HALOGEN LIGHT BARS

**REF 151TA3816** – 12V

**REF 151TA3817** – 24V

- Technology: halogen
- Mounting: magnetic mount
- Wire length: 3035 mm
- IP54
- 12V car plug
- Rotation rate:  $75 \pm 10$  rotations/minute
- Bulbs included

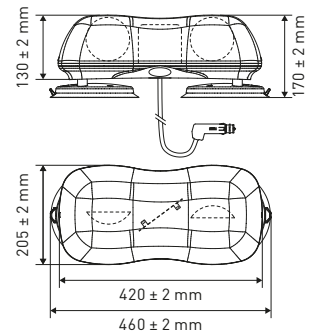

**REF 123TA8005** – Bulb: H1 12V 55W

**REF 123TA8006** – Bulb: H1 24V 70W

E-approved

**TOTAL SOURCE**<sup>®</sup>

**REF 151TA3819** – 12V

**REF 151TA3820** – 24V

- Technology: halogen
- Mounting: central bolt
- Wire length: 220 mm
- IP54
- 12V car plug
- Rotation rate: 160 rotations/minute
- Bulbs included

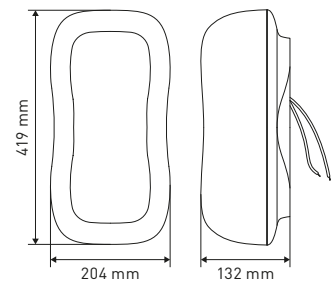

**REF 123TA8005** – Bulb: H1 12V 55W

**REF 123TA8006** – Bulb: H1 24V 70W

E-approved

**TOTAL SOURCE**<sup>®</sup>



## MAGNETIC LED STROBE LIGHT

### 1 REF 151TA3829

- Non-rechargeable version
- Powered by battery CR123A (REF 151TA3830)

### REF 151TA3832

Rechargeable light without charger

### 2 REF 151TA3831

Rechargeable version, universal charger included

### 3 REF 151TA3833

- Case with 6 pieces
- Rechargeable (case recharges all 6 LED lights simultaneously)

#### Characteristics:

- Height: 34 mm
- Ø 106,50 mm
- 9 different flashing patterns
- Shock-resistant
- Magnetic
- Water-resistant
- With universal charger

These lights can quickly and easily be deployed in case of:

- Works on and along the road
- Vehicle breakdown
- Loading and unloading of a vehicle
- Events



**TOTAL SOURCE®**

## XENON EX-PROOF STROBE

### REF 151TA3631 – 12-48V

- Technology: xenon
- Mounting: screws
- Length: 80 mm
- With: 75 mm
- Height: 260 mm
- IP66
- Ex-proof
- EX II 2 G, EX II 2 D
- Bulb not replaceable

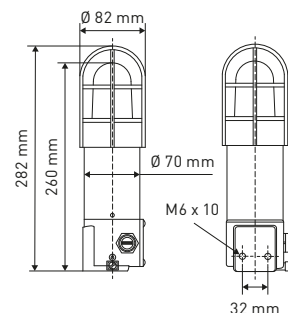

REF 151TA3632 – Support

REF 151TA3633 – Protection grill



**TOTAL SOURCE®**



## ADAPTER SOCKET "WELDING"



REF [106TA9131](#)

## ADAPTER SOCKET "SCREW-IN"



REF [106TA9132](#)

## TELESCOPIC ARM

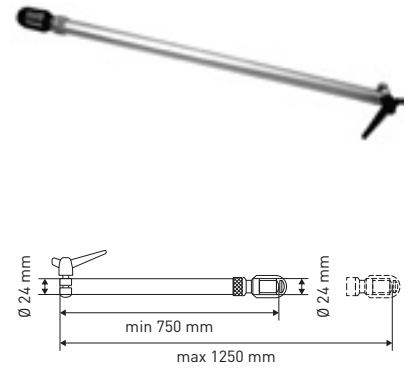

REF [106TA9177](#)

## ADAPTER SOCKET

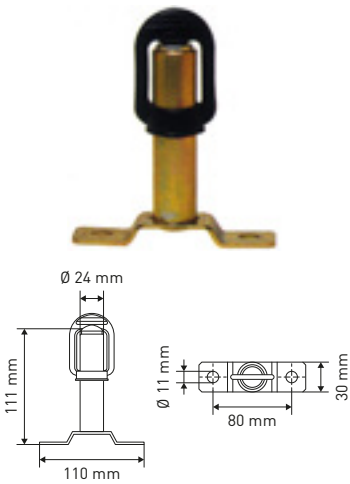

REF [106TA9176](#)

## ADAPTER SOCKET

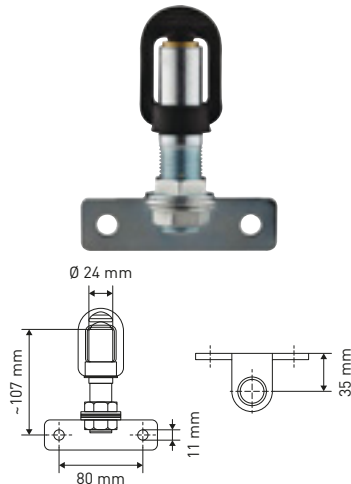

REF [126TA6019](#)

## CORNER ADAPTER SOCKET

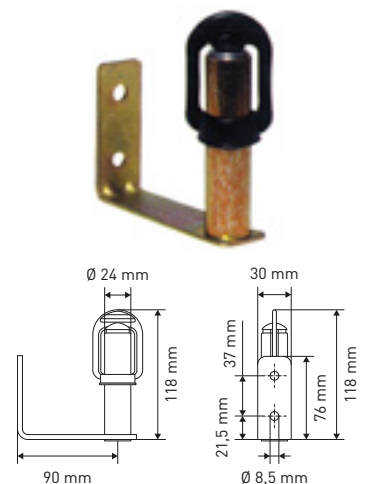

REF [106TA9175](#)

## ADJUSTABLE ADAPTER SOCKET

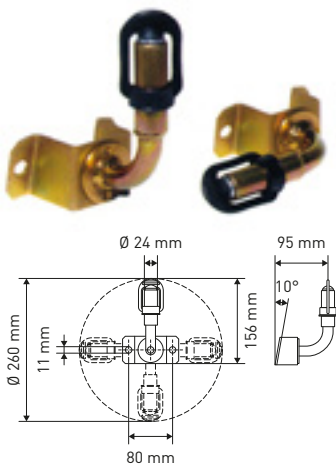

REF [106TA9174](#)

## ADAPTER SOCKET

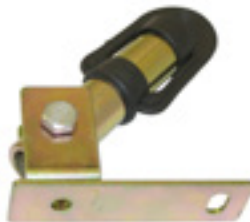

REF [131TA8886](#)

## ADAPTER SOCKET "FLEXIBLE"



REF [140TA8763](#)



# REAR LIGHTS



## NICE TO KNOW – REAR LIGHTS



The primary function of a rear light is to alert potential following vehicles of the presence on the road. To do so, a light with a red appearance is used: the red colour remains the most visible in all weather conditions. A second important function is to inform surrounding vehicles and persons of upcoming changes in direction.

Rear lights can have a single function or can also combine multiple functions in 1 light: a rear light, stop light, indicator light, reverse light, fog light and even number plate lighting.

Different technologies are available:

- rear lights with LED technology
- rear lights with incandescent bulbs

In some countries there is a requirement to have a red reflective triangle as part of the rear light for use on public roads.

Rear lights with bulb technology can be available in different voltages. These are according to the original products.

The rear lights with turn indicator are not equipped with an electronic flasher unit. Depending on the used technology of the light there is another flasher unit needed.

REF 164TA9406 is a perfect flasher unit for 12–24V turn indicators with bulb technology.

REF 164TA9407 is compact flasher unit for LED turn indicators between 12–24V.



## REVERSE/FOG LIGHT

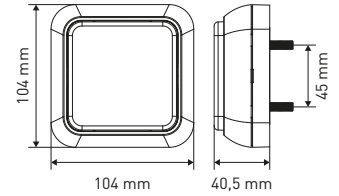

**REF 148TA3523** – 12-24V

- Technology: LED
- Mounting: 2 bolts
- Center distance: 45 mm
- Wire length: 190 mm
- Function: reverse

E-approved

**TOTAL SOURCE**<sup>®</sup>

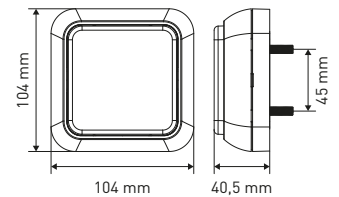

**REF 148TA3524** – 12-24V

- Technology: LED
- Mounting: 2 bolts
- Center distance: 45 mm
- Wire length: 190 mm
- Function: fog

E-approved

**TOTAL SOURCE**<sup>®</sup>



## REVERSE/FOG LIGHT

### REF 151TA5985

- Technology: incandescent
- Mounting: 2 bolts
- Center distance: 45 mm
- 12-24V
- Function: reverse
- Bulb not included

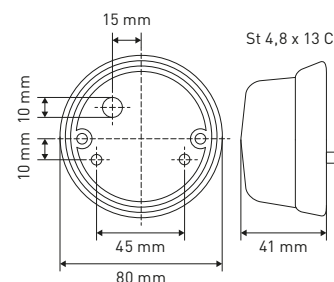

REF 103TA4541 – Bulb: SV8,5-8 12V 18W

REF 106TA4833 – Bulb: SV8,5-8 24V 18W



**E-approved**

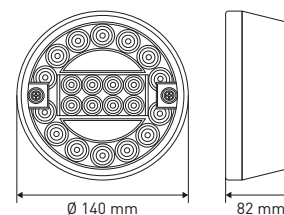

REF 163TA8808 – 12-24V

- Technology: LED
- Mounting: 2 bolts
- Center distance: 45 mm
- Function: fog

**E-approved**

**TOTAL SOURCE®**

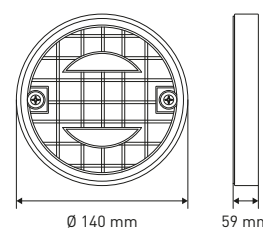

REF 163TA8809 – 12-24V

- Technology: LED
- Mounting: 2 bolts
- Center distance: 45 mm
- Function: reverse

**E-approved**

**TOTAL SOURCE®**





## REAR LIGHTS

- REF 151TA5968** – LH  
**REF 151TA5969** – RH + number plate light
- Technology: LED
  - Mounting: 2 bolts
  - Center distance: 60 mm
  - Wire length: 480 mm
  - 10–30V
  - Functions LH: rear, stop, turn
  - Functions RH: rear, stop, turn, license

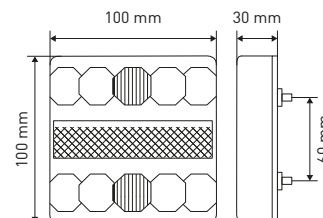

E-approved

**TOTAL SOURCE**<sup>®</sup>

- REF 163TA8804** – 12–24V
- Technology: LED
  - Mounting: 2 bolts
  - Center distance: 55 mm
  - Functions: rear, stop, turn, license

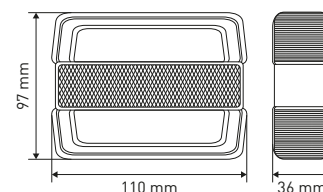

E-approved

**TOTAL SOURCE**<sup>®</sup>

- REF 151TA5970** – 12–24V
- Technology: LED
  - Mounting: 2 bolts
  - Center distance: 100 mm
  - Wire length: 1500 mm
  - Bulb not replaceable
  - Functions: rear, stop, turn

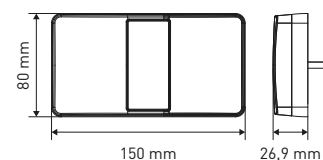

E-approved

**TOTAL SOURCE**<sup>®</sup>



## REAR LIGHTS

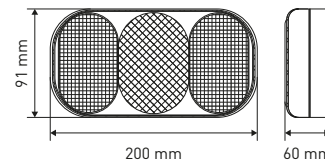

**REF 151TA6026** – 12-24V

- Technology: LED
- Mounting: 2 bolts
- Center distance: 195 mm
- Functions: rear, stop, turn

**E-approved**

**TOTAL SOURCE®**

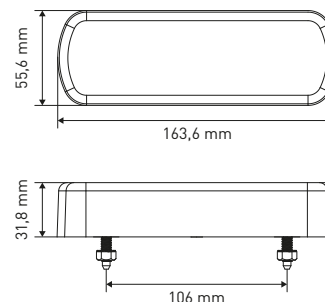

**REF 151TA5956** – 12-24V horizontal mount

**REF 151TA5957** – 12-24V vertical mount

- Technology: LED
- Mounting: 2 bolts
- Center distance: 106 mm
- Wire length: 1500 mm
- Functions: rear, stop, turn

**E-approved**

**TOTAL SOURCE®**

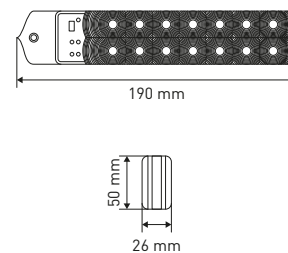

**REF 151TA5958** – 12V

- Technology: LED
- Mounting: 2 bolts
- Center distance: 170 mm
- Functions: rear, stop, turn, reverse
- Connector: E6 built-in

**TOTAL SOURCE®**



## REAR LIGHTS

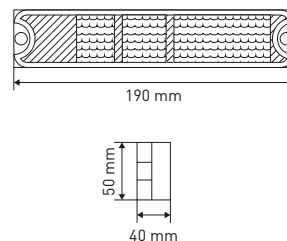

- REF 151TA5965** – 12V
- Technology: LED
  - Mounting: 2 bolts
  - Center distance: 170 mm
  - Functions: rear, stop, turn
  - Connector: O6 built-in

E-approved

**TOTAL SOURCE**<sup>®</sup>  
BRAND: SPEAKER

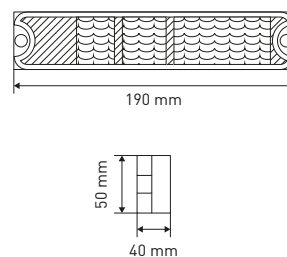

- REF 151TA6040** – 12V
- Technology: LED
  - Mounting: 2 bolts
  - Center distance: 170 mm
  - Functions: rear, stop, turn
  - Connector: A6

**TOTAL SOURCE**<sup>®</sup>

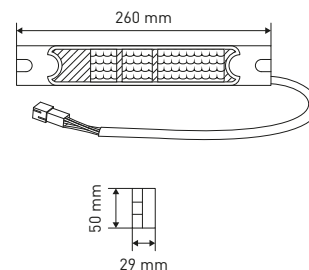

- REF 151TA5966** – 12V
- Technology: LED
  - Mounting: 2 bolts
  - Center distance: 238 mm
  - Wire length: 520 mm
  - Functions: rear, stop, turn, reverse
  - Connector: O6

**TOTAL SOURCE**<sup>®</sup>



## REAR LIGHTS

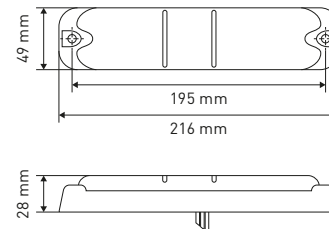

**REF 134TA3713** – 12V single LED light

**REF 134TA3714** – 24V single LED light

- Technology: LED
- Mounting: 2 bolts
- Center distance: 195 mm
- Wire length: 3000 mm
- Functions: rear, stop, turn, reverse

**E-approved**

**TOTAL SOURCE**<sup>®</sup>  
BRAND: SPEAKER

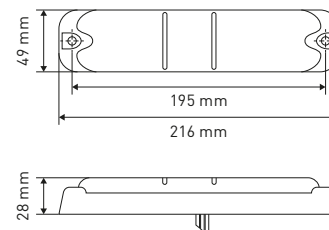

**REF 151TA5964** – 9-56V

- Technology: LED
- Mounting: 2 bolts
- Center distance: 195 mm
- Wire length: 215 mm
- Functions: rear, stop, turn, reverse
- Connector: C6

**TOTAL SOURCE**<sup>®</sup>

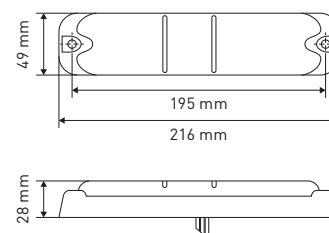

**REF 151TA6030** – Kit: 2 lights + flasher

- Technology: LED
- Mounting: 2 bolts
- Center distance: 195 mm
- Wire length: 310 mm
- Functions: rear, stop, turn, reverse

**REF 151TA6028** – 9-56V

**REF 151TA6029** – Flasher

**TOTAL SOURCE**<sup>®</sup>



## REAR LIGHTS

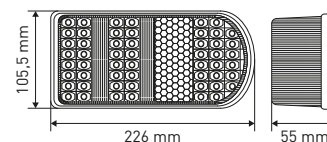

**REF 163TA8806** – 12-24V LH

**REF 163TA8805** – 12-24V RH

- Technology: LED
- Mounting: 2 bolts M6
- Center distance: 150 mm
- Functions LH: rear, stop, turn, fog, license
- Functions RH: rear, stop, turn, reverse, license

**E-approved**

**TOTAL SOURCE®**



**LH**



**RH**

**REF 148TA3521** – 12-24V LH

**REF 148TA3522** – 12-24V RH

- Technology: LED
- Mounting: 2 bolts
- Center distance: 152 mm
- Functions LH: rear, stop, turn, fog, license
- Functions RH: rear, stop, turn, reverse, license, reflector triangle

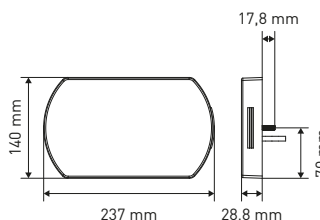

**E-approved**

**TOTAL SOURCE®**



**LH**



**RH**

**REF 148TA3526** – 12-24V LH

**REF 148TA3527** – 12-24V RH

- Technology: LED
- Mounting: 2 bolts
- Center distance: 152 mm
- Functions: rear, stop, turn, fog, reflector

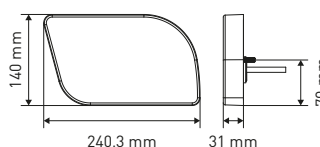

**E-approved**

**TOTAL SOURCE®**



## REAR LIGHTS

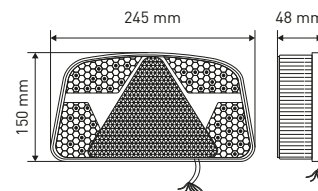

**REF 163TA8803** – 12 LH

**REF 163TA8802** – 12V RH

- Technology: LED
- Mounting: 2 bolts M6
- Center distance: 152 mm
- Functions: rear, stop, turn, reverse, fog, license, reflector triangle

**E-approved**

**TOTAL SOURCE®**

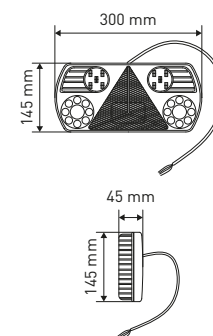

**REF 163TA8801** – 12-24V LH

**REF 163TA8800** – 12-24V RH

- Technology: LED
- Mounting: 2 bolts
- Center distance: 152 mm
- Functions LH: rear, stop, turn, fog, license, reflector triangle
- Functions RH: rear, stop, turn, reverse, license, reflector triangle

**E-approved**

**TOTAL SOURCE®**

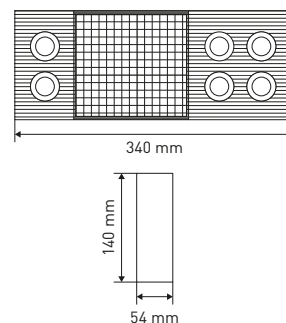

**REF 151TA5972** – 12-24V LH

**REF 151TA5971** – 12-24V RH

- Technology: LED
- Mounting: 2 bolts
- Center distance: 152 mm
- Functions: rear, stop, turn, reverse, DI, reflex
- Connector: A7, 2 x E2 built-in

**E-approved**

**TOTAL SOURCE®**



## REAR LIGHTS

### REF 151TA5993

- Technology: incandescent
- Mounting: 2 bolts
- Center distance: 45 mm
- 12-24V
- Functions: rear, stop, turn
- Bulbs not included

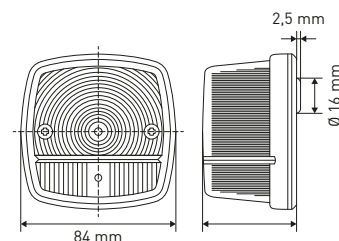

- REF 103TA4537 – Bulb: SV8,5-8 12V 5W
- REF 100TA2215 – Bulb: BA15S 12V 21W
- REF 103TA4539 – Bulb: SV8,5-8 24V 5W
- REF 103TA4603 – Bulb: BA15S 24V 21W



E-approved

### REF 151TA5996

- Technology: incandescent
- Mounting: 2 bolts
- Center distance: 45 mm
- 12-24V
- Functions: stop
- Bulbs not included

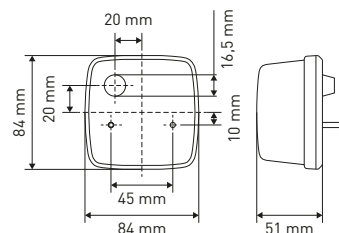

- REF 103TA4537 – Bulb: SV 8,5-8 12V 5W
- REF 100TA2215 – Bulb: BA15S 12V 21W
- REF 103TA4539 – Bulb: SV8,5-8 24V 5W
- REF 103TA4603 – Bulb: BA15S 24V 21W
- REF 151TA5997 – Replacement lens red



E-approved

### REF 151TA5998 – LH

### REF 151TA5999 – RH

- Technology: incandescent
- Mounting: 2 bolts
- Center distance: 45 mm
- 12V
- Functions: rear, stop, turn
- Bulbs not included

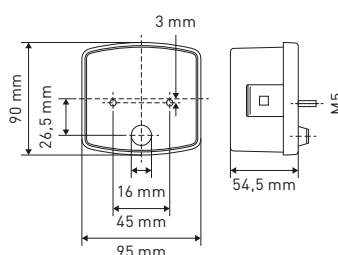

- REF 103TA4596 – Bulb: BA15S 12V 10W
- REF 100TA2215 – Bulb: BA15S 12V 21W
- REF 151TA6000 – Replacement lens LH
- REF 144TA1690 – Replacement lens RH



E-approved



## REAR LIGHTS

**REF 151TA5988** – LH  
**REF 151TA5989** – RH

- Technology: incandescent
- Mounting: 2 bolts
- Center distance: 45 mm
- Horizontal and vertical mount
- 12–24V
- Functions: rear, stop, turn
- Bulbs not included

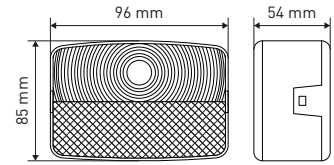

**REF 123TA7983** – Bulb: BA15S 12V 10W  
**REF 100TA2215** – Bulb: BA15S 12V 21W  
**REF 123TA7984** – Bulb: BA15S 24V 10W  
**REF 103TA4603** – Bulb: BA15S 24V 21W  
**REF 151TA5990** – Replacement lens

**E-approved**



**REF 151TA5995**

- Technology: incandescent
- Mounting: 2 bolts
- Center distance: 45 mm
- Horizontal & vertical mount
- 12–24V
- Functions: rear, stop, turn, license
- Bulbs not included

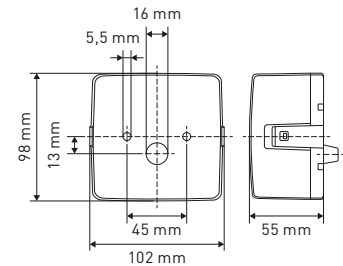

**REF 103TA4596** – Bulb: BA15S 12V 10W  
**REF 100TA2215** – Bulb: BA15S 12V 21W  
**REF 100TA2195** – Bulb: BA15S 24V 10W  
**REF 100TA2218** – Bulb: BA15S 24V 21W  
**REF 150TA3817** – Replacement lens

**E-approved**



**REF 151TA5986**

- Technology: incandescent
- Mounting: 2 bolts
- Center distance: 45 mm
- 12–24V
- Functions: rear, stop, turn, license
- Bulbs not included

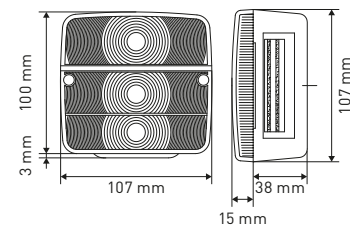

**REF 100TA2215** – Bulb: BA15S 12V 21W  
**REF 103TA4621** – Bulb: BAY15D 12V 21/5W  
**REF 106TA4830** – Bulb: SV8,5 12V 5W  
**REF 103TA4603** – Bulb: BA15S 24V 21W  
**REF 106TA4875** – Bulb: BAY15D 24V 21/5W  
**REF 106TA4540** – Bulb: SV8,5 24V 5W  
**REF 151TA5987** – Replacement lens

**E-approved**

**TOTAL SOURCE®**

BRAND: A.J.B.A





## REAR LIGHTS

### REF 151TA6058

- Technology: incandescent
- Mounting: 2 bolts
- Center distance: 45 mm
- 12-24V
- Functions: rear, stop, turn, license
- Bulbs not included

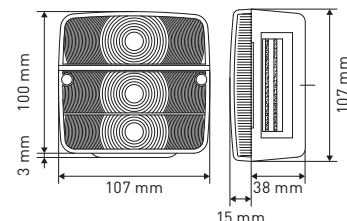

- REF [100TA2215](#) – Bulb: BA15S 12V 21W
- REF [103TA4621](#) – Bulb: BAY15D 12V 21/5W
- REF [103TA4603](#) – Bulb: BA15S 24V 21W
- REF [106TA4875](#) – Bulb: BAY15D 24V 21/5W
- REF [151TA5987](#) – Replacement lens

E-approved

**TOTAL SOURCE**<sup>®</sup>

### REF 151TA6059

- Technology: incandescent
- Mounting: 2 bolts
- Center distance: 45 mm
- 12-24V
- Functions: rear, stop, turn
- Bulbs not included

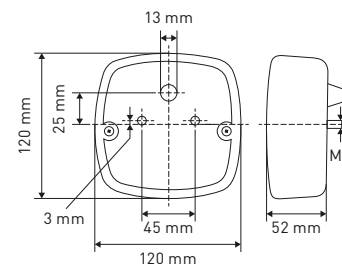

- REF [103TA4596](#) – Bulb: BA15S 12V 10W
- REF [100TA2215](#) – Bulb: BA15S 12V 21W
- REF [100TA2195](#) – Bulb: BA15S 24V 10W
- REF [100TA2218](#) – Bulb: BA15S 24V 21W
- REF [150TA3812](#) – Replacement lens

E-approved



### REF 151TA5992

- Technology: incandescent
- Mounting: 2 bolts
- Center distance: 45 mm
- 12-24V
- Functions: rear, stop, turn, license
- Bulbs not included

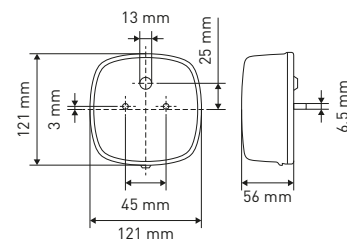

- REF [123TA7983](#) – Bulb: BA15S 12V 10W
- REF [100TA2215](#) – Bulb: BA15S 12V 21W
- REF [123TA7984](#) – Bulb: BA15S 24V 10W
- REF [103TA4603](#) – Bulb: BA15S 24V 21W
- REF [106TA1280](#) – Replacement lens

E-approved





## REVERSE LIGHT

### REF 151TA6002

- Technology: incandescent
- Mounting: 2 bolts
- Center distance: 45 mm
- 12-24V
- Function: reverse
- Bulbs not included

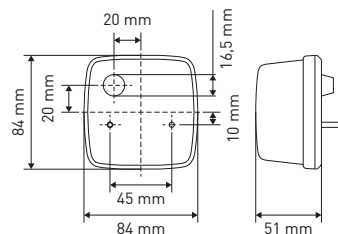

- REF 103TA4537** – Bulb: SV 8,5-8 12V 5W
- REF 100TA2215** – Bulb: BA15S 12V 21W
- REF 103TA4539** – Bulb: SV8,5-8 24V 5W
- REF 103TA4603** – Bulb: BA15S 24V 21W
- REF 151TA6001** – Replacement lens white



E-approved

### REF 151TA6003

- Technology: incandescent
- Mounting: 2 bolts
- Center distance: 45 mm
- 12-24V
- Function: reverse
- Bulbs not included

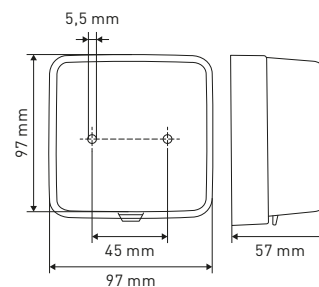

- REF 100TA2215** – Bulb: BA15S 12V 21W
- REF 103TA4603** – Bulb: BA15S 24V 21W



E-approved



## REAR LIGHTS

### REF [151TA6031](#) – 12V

- Technology: incandescent
- Mounting: 2 bolts
- Center distance: 58 mm
- Functions: rear, brake, turn
- Bulbs included

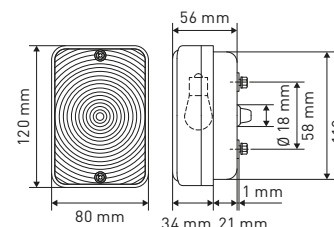

- REF [100TA2215](#) – Bulb: BA15S 12V 21W
- REF [100TA2246](#) – Bulb: BAY15D 12V 21/5W
- REF [151TA6033](#) – Replacement lens



**E-approved**

### REF [151TA6106](#) – 12V

- Technology: incandescent
- Mounting: pedestal
- Wire length: 300 mm
- Function: fog
- Bulb included
- Connector: F2

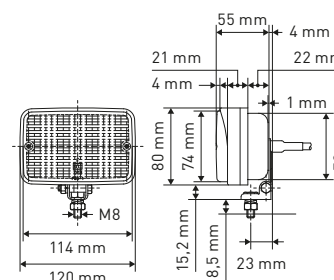

- REF [100TA2215](#) – Bulb: BA15S 12V 21W



### REF [151TA5973](#) – 24V LH REF [151TA5974](#) – 24V RH

- Technology: incandescent
- Mounting: 2 bolts
- Center distance: 88 mm
- Wire length: 80 mm
- Functions: rear, stop, reverse
- Bulbs included
- Connector: K4

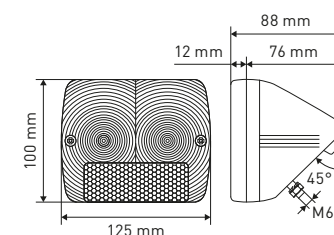

- REF [100TA2218](#) – Bulb: BA15S 24V 21W
- REF [100TA2249](#) – Bulb: BAY15D 24V 21/5W
- REF [150TA3126](#) – Replacement lens LH
- REF [150TA3127](#) – Replacement lens RH



**E-approved**



## REAR LIGHTS

### REF 151TA6081 – 12V

- Technology: incandescent
- Mounting: 2 bolts
- Functions: rear, stop, turn
- Bulbs included

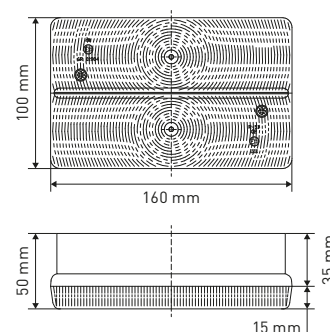

- REF 100TA2215 – Bulb: BA15S 12V 21W
- REF 103TA4621 – Bulb: BAY15D 12V 21/5W
- REF 150TA4534 – Replacement lens

E-approved

**TOTAL SOURCE**<sup>®</sup>  
BRAND: BRITAX

### REF 151TA5921 – 12V

- REF 151TA5922 – 24V
- Technology: incandescent
- Mounting: 2 bolts
- Center distance: 160 mm
- Wire length: 500 mm
- Functions: rear, stop, reverse
- Bulbs included
- Connector: B4

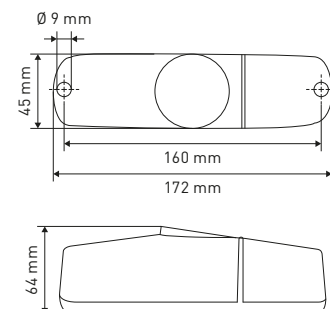

- REF 100TA2119 – Bulb: S8,5 12V 10W
- REF 106TA4904 – Bulb: BAY15D 12V 23/8W
- REF 123TA7984 – Bulb: BA15S 24V 10W
- REF 100TA2250 – Bulb: BAY15D 24V 25/10W
- REF 150TA1265 – Replacement lens white
- REF 150TA1262 – Replacement lens red

**TOTAL SOURCE**<sup>®</sup>

### REF 151TA6015 – 48V

- Technology: incandescent
- Mounting: 2 bolts
- Center distance: 160,5 mm
- Wire length: 295 mm
- Functions: rear, stop, turn
- Bulbs included
- Connector: B4

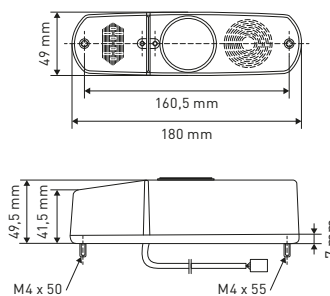

- REF 123TA7986 – Bulb: BAY15D 48V 10W
- REF 123TA7990 – Bulb: BAY15D 48V 25/10W
- REF 150TA1263 – Replacement lens red
- REF 150TA1276 – Replacement lens clear

**TOTAL SOURCE**<sup>®</sup>



## REAR LIGHTS

### REF [151TA5923](#) – 12V

- Technology: incandescent
- Mounting: 2 bolts
- Center distance: 176 mm
- Wire length: 430 mm
- Functions: rear, stop, reverse
- Bulbs included
- Connector: C4

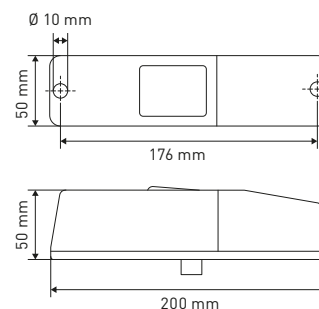

- REF [100TA2215](#) – Bulb: BA15S 12V 21W
- REF [100TA2246](#) – Bulb: BAY15D 12V 21/5W
- REF [151TA3896](#) – Replacement lens

**TOTAL SOURCE®**

### REF [151TA3918](#) – 48V wire length: 160 mm connector: H6

### REF [151TA3895](#) – 48V wire length: 520 mm connector: C4

- Technology: incandescent
- Mounting: 2 bolts
- Center distance: 176 mm
- Wire length: 160 mm
- Functions: rear, stop
- Bulbs included

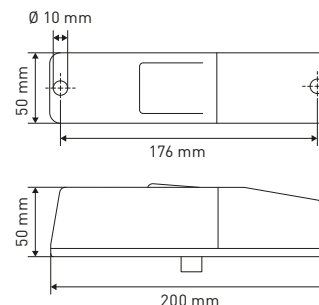

- REF [103TA4598](#) – Bulb: BAY15D 48V 10W
- REF [106TA4877](#) – Bulb: BAY15D 48V 25/10W
- REF [151TA3896](#) – Replacement lens
- REF [151TA3919](#) – Replacement housing

**TOTAL SOURCE®**

### REF [151TA3910](#) – 12V

- Technology: incandescent
- Mounting: 2 bolts
- Center distance: 176 mm
- Wire length: 430 mm
- Functions: rear, stop, turn
- Bulbs included
- Connector: D4

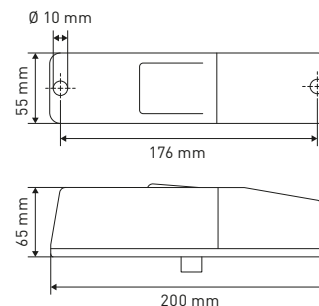

- REF [100TA2215](#) – Bulb: BA15S 12V 21W
- REF [100TA2246](#) – Bulb: BAY15D 12V 21/5W

**TOTAL SOURCE®**



## REAR LIGHTS

### REF [151TA5919](#) – 12V

- Technology: incandescent
- Mounting: 2 bolts
- Center distance: 192 mm
- Wire length: 1000 mm
- Functions: rear, stop, turn, reverse
- Bulbs included
- Connector: A3

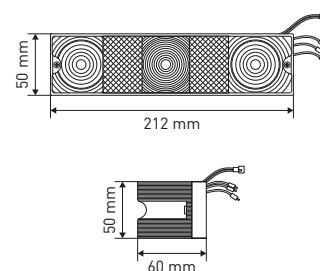

REF [100TA2214](#) – Bulb: BA15S 12V 18W

REF [106TA4904](#) – Bulb: BAY15D 12V 23/8W

REF [150TA9426](#) – Replacement lens kit

**TOTAL SOURCE®**

### REF [151TA5906](#) – 12V

- Technology: incandescent
- Mounting: 2 bolts
- Center distance: 192 mm
- Functions: rear, stop, turn, reverse
- Bulbs included

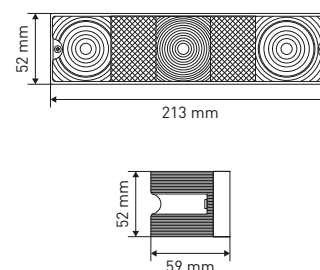

REF [106TA4861](#) – Bulb: BA15S 12V 18W

REF [106TA4904](#) – Bulb: BAY15D 12V 23/8W

REF [150TA9426](#) – Replacement lens kit

REF [151TA5907](#) – Metal guard

**TOTAL SOURCE®**

### REF [151TA3909](#) – 24V

- Technology: incandescent
- Mounting: 2 bolts
- Center distance: 192 mm
- Wire length: 180 mm
- Functions: rear, stop, turn, reverse
- Bulbs included
- Connector: B6

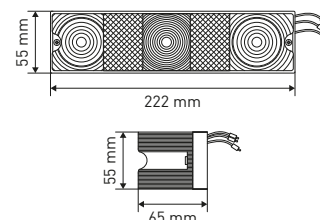

REF [123TA7984](#) – Bulb: BA15S 24V 10W

REF [100TA2249](#) – Bulb: BAY15D 24V 21/5W

REF [103TA4603](#) – Bulb: BA15S 24V 21W

REF [151TA3894](#) – Replacement lens

**TOTAL SOURCE®**



## REAR LIGHTS



### REF [151TA3916](#) – 24V

- Technology: incandescent
- Mounting: 2 bolts
- Center distance: 192 mm
- Wire length: 500 mm
- Functions: rear, stop, turn, reverse
- Bulbs included
- Connector: O6

- REF [123TA7984](#) – Bulb: BA15S 24V 10W
- REF [100TA2250](#) – Bulb: BAY15D 24V 25/10W
- REF [100TA2219](#) – Bulb: BA15S 24V 25W
- REF [151TA3917](#) – Replacement lens kit

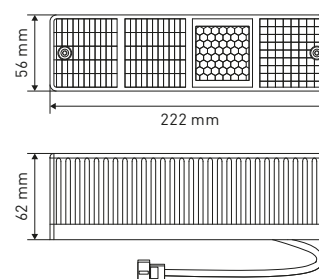

**TOTAL SOURCE®**



### REF [151TA6027](#) – 12V

- Technology: incandescent
- Mounting: 2 bolts
- Center distance: 192 mm
- Wire length: 900 mm
- Functions: rear, stop, turn, reverse
- Bulbs included
- Connector: A3

- REF [106TA1277](#) – Bulb: BA15S 12V 10W
- REF [100TA2246](#) – Bulb: BAY15D 12V 21/5W
- REF [100TA2215](#) – Bulb: BA15S 12V 21W
- REF [151TA3894](#) – Replacement lens

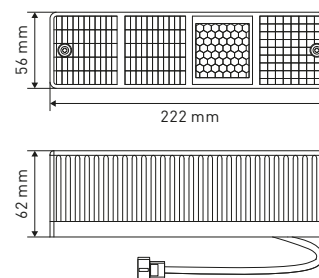

**TOTAL SOURCE®**



## REAR LIGHTS



- REF 151TA5916** – 12V
- REF 151TA5917** – 24V
- REF 151TA5918** – 48V
- Technology: incandescent
- Mounting: 2 bolts
- Center distance: 192 mm
- Wire length: 500 mm
- Functions: rear, stop, turn, reverse
- Bulbs included
- Connector: O6

- REF 123TA7983** – Bulb: BA15S 12V 10W
- REF 100TA2215** – Bulb: BA15S 12V 21W
- REF 100TA2246** – Bulb: BAY15D 12V 21/5W
- REF 123TA7984** – Bulb: BA15S 24V 10W
- REF 100TA2250** – Bulb: BAY15D 24V 25/10W
- REF 100TA2219** – Bulb: BA15S 24V 25W
- REF 123TA7986** – Bulb: BAY15D 48V 10W
- REF 123TA7990** – Bulb: BAT15D 48V 25/10W
- REF 123TA7992** – Bulb: BAY15D 48V 25W
- REF 151TA3894** – Replacement lens
- REF 123TA7992** – Bulb: BAY15D 48V 25W
- REF 151TA3894** – Replacement lens

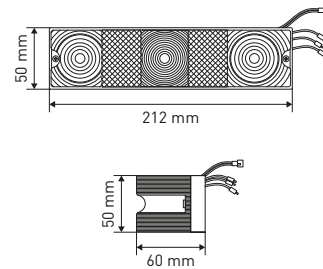

**TOTAL SOURCE®**



- REF 151TA3892** – 24V
- Technology: incandescent
- Mounting: 2 bolts
- Center distance: 192 mm
- Wire length: 205 mm
- Functions: rear, stop, turn, reverse
- Bulbs included
- Connector: B6

- REF 123TA7984** – Bulb: BA15S 24V 10W
- REF 100TA2249** – Bulb: BAY15D 24V 21/5W
- REF 103TA4603** – Bulb: BA15S 24V 21W

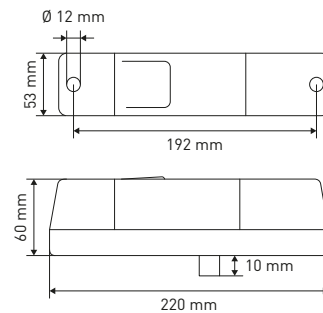

**TOTAL SOURCE®**





## REAR LIGHTS

### REF [151TA3893](#) – 48V

- Technology: incandescent
- Mounting: 2 bolts
- Center distance: 192 mm
- Wire length: 250 mm
- Functions: rear, stop, turn, reverse
- Bulbs included
- Connector: F6

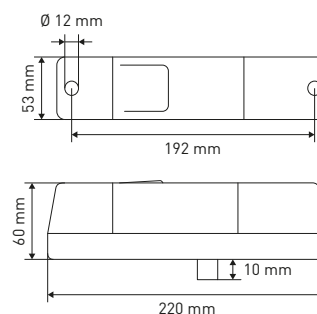

- REF [119TA8919](#) – Bulb: BA15D 48V 10W
- REF [123TA7990](#) – Bulb: BAT15D 48V 25/10W
- REF [123TA7992](#) – Bulb: BAY15D 48V 25W
- REF [151TA3894](#) – Replacement lens

**TOTAL SOURCE®**

### REF [151TA3897](#) – 12V

- REF [151TA3898](#) – 12V wire length: 1230 mm
- Technology: incandescent
- Mounting: 2 bolts
- Center distance: 190 mm
- Functions: rear, stop, turn, reverse
- Bulbs included
- Connector: G6

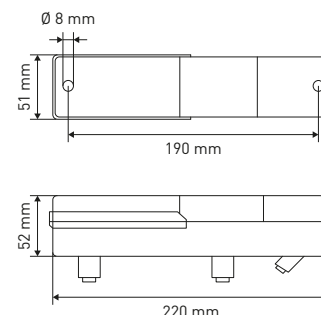

- REF [100TA2191](#) – Bulb: BA15S 12V 10W
- REF [103TA4601](#) – Bulb: BA15S 12V 23W
- REF [106TA4904](#) – Bulb: BAY15D 12V 23/8W
- REF [151TA3899](#) – Replacement lens

**TOTAL SOURCE®**

### REF [151TA3900](#) – 12V

- REF [151TA3901](#) – 24V
- Technology: incandescent
- Mounting: 2 bolts
- Center distance: 190 mm
- Wire length: 500 mm
- Functions: rear, stop, turn, reverse
- Bulbs included
- Connector: D3

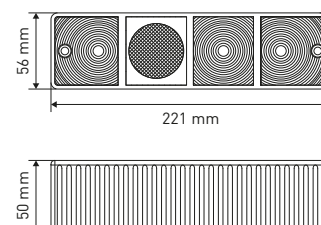

- REF [100TA2191](#) – Bulb: BA15S 12V 10W
- REF [103TA4601](#) – Bulb: BA15S 12V 23W
- REF [106TA4904](#) – Bulb: BAY15D 12V 23/8W
- REF [106TA4860](#) – Bulb: BA15S 10W
- REF [103TA4604](#) – Bulb: BA15S 24V 25W
- REF [103TA4623](#) – Bulb: BAY15D 24V 25/10W
- REF [151TA3902](#) – Replacement lens

**TOTAL SOURCE®**



## REAR LIGHTS

### REF [151TA5920](#) – 12V

- Technology: incandescent
- Mounting: 2 bolts
- Center distance: 190 mm
- Wire length: 1020 mm
- Functions: rear, stop, turn, reverse, license
- Bulbs included
- Connector: L6

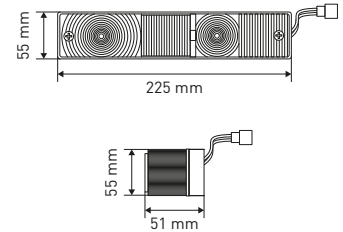

### REF [123TA7983](#) – Bulb: BA15S 12V 10W

### REF [100TA2215](#) – Bulb: BA15S 12V 21W

### REF [123TA7988](#) – Bulb: BAY15D 12V 21/5W

### REF [151TA3899](#) – Replacement lens

**TOTAL SOURCE®**

### REF [151TA5908](#) – 12V wire length: 710 mm

### REF [151TA5909](#) – 12V wire length: 770 mm

### REF [151TA5911](#) – 12V wire length: 1100 mm

### REF [151TA5910](#) – 24V wire length: 770 mm

- Technology: incandescent
- Mounting: 2 bolts
- Center distance: 190 mm
- Functions: rear, stop, turn, reverse
- Bulbs included
- Connector: G6

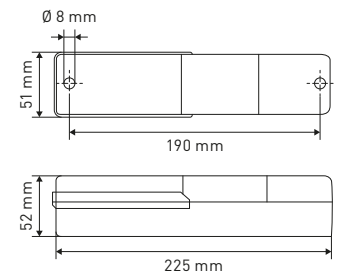

### REF [103TA4596](#) – Bulb: BA15S 12V 10W

### REF [100TA2215](#) – Bulb: BA15S 12V 21W

### REF [123TA7988](#) – Bulb: BAY15D 12V 21/5W

### REF [123TA7984](#) – Bulb: BA15S 24V 10W

### REF [103TA4603](#) – Bulb: BA15S 24V 21W

### REF [103TA4623](#) – Bulb: BAY15D 24V 25/10W

### REF [151TA3899](#) – Replacement lens

**TOTAL SOURCE®**

### REF [151TA3908](#) – 12V

- Technology: incandescent
- Mounting: 2 bolts
- Center distance: 190 mm
- Wire length: 185 mm
- Functions: rear, stop, turn, reverse
- Bulbs included
- Used for Hyundai
- Connector: L6

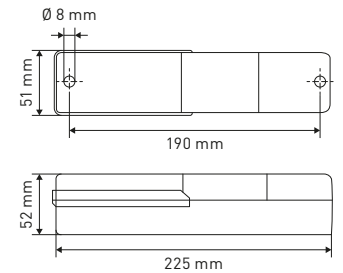

### REF [100TA2191](#) – Bulb: BA15S 12V 10W

### REF [100TA2215](#) – Bulb: BA15S 12V 21W

### REF [100TA2246](#) – Bulb: BAY15D 12V 21/5W

**TOTAL SOURCE®**



## REAR LIGHTS



**REF 151TA5924** – 12V

- Technology: incandescent
- Mounting: 2 bolts
- Center distance: 190 mm
- Wire length: 180 mm
- Functions: rear, stop, turn, reverse
- Bulbs included
- Connector: N6

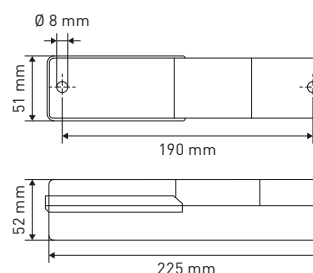

- REF 100TA2191** – Bulb: BA15S 12V 10W
- REF 100TA2215** – Bulb: BA15S 12V 21W
- REF 123TA7988** – Bulb: BAY15D 12V 21/5W

**TOTAL SOURCE®**



**REF 151TA3905** – 12V

**REF 151TA3906** – 24V

- Technology: incandescent
- Mounting: 2 bolts
- Center distance: 100 mm
- Wire length: 54 mm
- Functions: rear, stop, turn, reverse
- Bulbs included
- Connector: D4

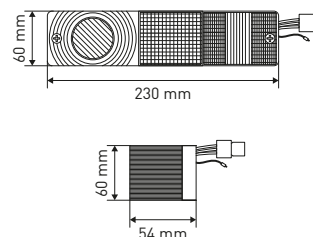

- REF 103TA4596** – Bulb: BA15S 12V 10W
- REF 100TA2215** – Bulb: BA15S 12V 21W
- REF 106TA4877** – Bulb: BAY15D 12V 21/5W
- REF 123TA7984** – Bulb: BA15S 24V 10W
- REF 103TA4603** – Bulb: BA15S 24V 21W
- REF 142TA1225** – Bulb: BA15D 24V 21/5W

**TOTAL SOURCE®**



## REAR LIGHTS

- REF 151TA5899** – 12V wire length: 770 mm
- REF 151TA5900** – 12V wire length: 1300 mm
- REF 151TA5901** – 24V wire length: 710 mm
- REF 151TA5902** – 36V wire length: 740 mm
- REF 151TA5903** – 48V wire length: 800 mm
- REF 151TA5904** – 48V wire length: 1050 mm

- Technology: incandescent
- Mounting: 2 bolts
- Center distance: 216 mm
- Functions: rear, stop, turn, reverse
- Bulbs included
- Connector: L2

- REF 106TA1277** – Bulb: BA15S 12V 10W
- REF 103TA4611** – Bulb: BA15D 12V 21W
- REF 106TA4874** – Bulb: BAY15D 12V 23/8W
- REF 123TA7984** – Bulb: BA15S 24V 10W
- REF 103TA4603** – Bulb: BA15S 24V 21W
- REF 100TA2249** – Bulb: BAY15D 24V 21/5W
- REF 100TA2197** – Bulb: BA15S 36V 10W
- REF 100TA2257** – Bulb: BAY15D 36V 25W
- REF 106TA4876** – Bulb: BAY15D 36V 25/10W
- REF 123TA7985** – Bulb: BA15S 48V 10W
- REF 106TA4865** – Bulb: BAY15D 48V 25W
- REF 106TA4877** – Bulb: BAY15D 48V 25/10W
- REF 106TA1391** – Replacement lens

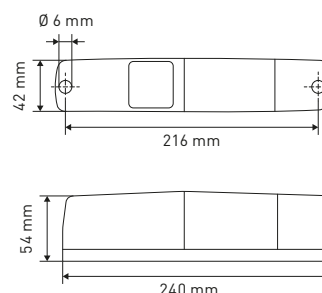

**TOTAL SOURCE®**



- REF 151TA3886** – 48V
- Technology: incandescent
- Mounting: 2 bolts
- Center distance: 216 mm
- Wire length: 980 mm
- Functions: rear, stop, turn, reverse
- Bulbs included
- Connector: 1 x D1, 2 x G1, 2 x H1

- REF 141TA9772** – Bulb: BA15S 48V 10W
- REF 106TA4865** – Bulb: BA15S 48V 25W
- REF 106TA4877** – Bulb: BAY15D 48V 25/10W
- REF 150TA1089** – Replacement lens white
- REF 150TA1090** – Replacement lens orange
- REF 149TA8737** – Replacement lens red
- REF 151TA3887** – Replacement guard

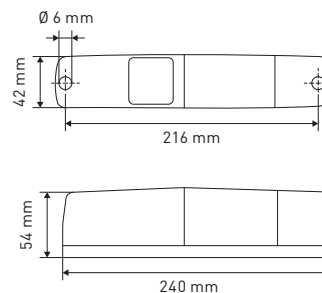

**TOTAL SOURCE®**



## REAR LIGHTS

**REF 151TA3921** – 12V

**REF 151TA3922** – 24V

**REF 151TA3923** – 36V

**REF 151TA3924** – 48V

- Technology: incandescent
- Mounting: 2 bolts
- Center distance: 240 mm
- Functions: rear, stop, turn, reverse
- Bulbs included
- Connector: O6

**REF 100TA2191** – Bulb: BA15S 12V 10W

**REF 100TA2215** – Bulb: BA15S 12V 21W

**REF 123TA7988** – Bulb: BAY15D 12V 21/5W

**REF 106TA4860** – Bulb: BA15S 24V 10W

**REF 100TA2218** – Bulb: BA15S 24V 21W

**REF 123TA7989** – Bulb: BAY15D 24V 21/5W

**REF 122TA9120** – Bulb: BAY15D 36V 8W

**REF 100TA2257** – Bulb: BAY15D 36V 25W

**REF 100TA2251** – Bulb: BAY15D 36V 25/10W

**REF 141TA9772** – Bulb: BA15S 48V 10W

**REF 144TA5468** – Bulb: BA15S 48V 25W

**REF 106TA4877** – Bulb: BAY15D 48V 25/10W

**REF 151TA3925** – Support

**REF 151TA3926** – Replacement lens

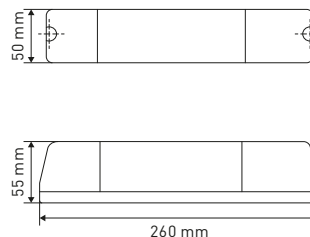

**TOTAL SOURCE®**

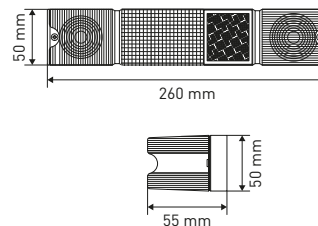

**REF 151TA3914** – 12V wire length: 360 mm

**REF 151TA3915** – 12V wire length: 740 mm

- Technology: incandescent
- Mounting: 2 bolts
- Center distance: 240 mm
- Functions: rear, stop, turn, reverse
- Bulbs included
- Connector: M6

**REF 100TA2191** – Bulb: BA15S 12V 10W

**REF 100TA2215** – Bulb: BA15S 12V 21W

**REF 123TA7988** – Bulb: BA15S 12V 21W

**REF 151TA3926** – Replacement lens

**TOTAL SOURCE®**



## REAR LIGHTS

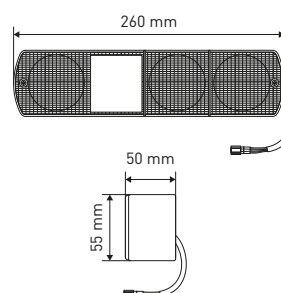

**REF 151TA6066** – 12V

- Technology: incandescent
- Mounting: 2 bolts
- Wire length: 190 mm
- Functions: rear, stop, turn, reverse
- Bulbs included
- Connector: O6

**REF 100TA2191** – Bulb: BA15S 12V 10W

**REF 100TA2215** – Bulb: BA15S 12V 21W

**REF 123TA7988** – Bulb: BA15S 12V 21W

**REF 150TA3536** – Replacement lens

**TOTAL SOURCE®**

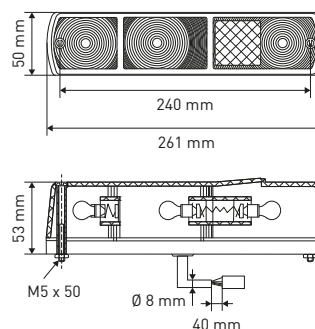

**REF 151TA3888** – 12V

**REF 151TA3889** – 24V

**REF 151TA3890** – 48V

- Technology: incandescent
- Mounting: 2 bolts
- Center distance: 240 mm
- Wire length: 490 mm
- Functions: rear, stop, turn, reverse
- Bulbs included
- Used for Mitsubishi
- Connector: O6

**REF 100TA2191** – Bulb: BA15S 12V 10W

**REF 103TA4602** – Bulb: BA15S 12V 25W

**REF 106TA4904** – Bulb: BAY15D 12V 23/8W

**REF 123TA7984** – Bulb: BA15S 24V 10W

**REF 103TA4604** – Bulb: BA15S 24V 25W

**REF 100TA2250** – Bulb: BAY15D 24V 25/10W

**REF 161TA6024** – Bulb: BA15S 48V 10W

**REF 144TA5468** – Bulb: BA15S 48V 25W

**REF 106TA4877** – Bulb: BAY15D 48V 25/10W

**REF 151TA3891** – Replacement lens

**REF 151TA3891** – Replacement lens kit

**TOTAL SOURCE®**



## REAR LIGHTS

### REF [151TA3907](#) – 48V

- Technology: incandescent
- Mounting: 2 bolts
- Center distance: 240 mm
- Wire length: 145 mm
- Functions: rear, stop, turn, reverse
- Bulbs included
- Used for TCM
- Connector: O6

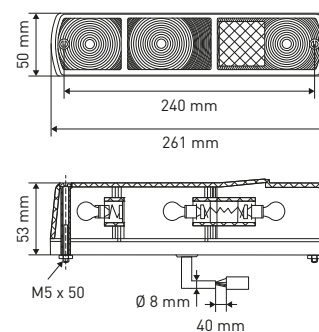

### REF [161TA6024](#) – Bulb: BA15S 48V 10W

### REF [144TA5468](#) – Bulb: BA15S 48V 25W

### REF [144TA5615](#) – Bulb: BAY15D 48V 25/10W

### REF [151TA3891](#) – Replacement lens

**TOTAL SOURCE®**

### REF [151TA6041](#) – 12V

- Technology: incandescent
- Mounting: 2 bolts
- Center distance: 240 mm
- Wire length: 200 mm
- Functions: rear, stop, turn, reverse
- Bulbs included
- Connector: A5

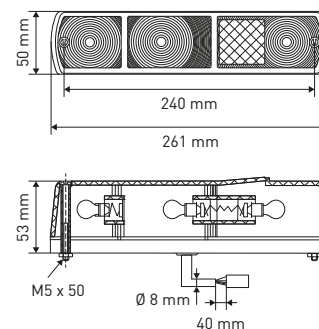

### REF [100TA2191](#) – Bulb: BA15S 12V 10W

### REF [101TA9495](#) – Bulb: BA15S 12V 25W

### REF [106TA4904](#) – Bulb: BAY15D 12V 23/8W

### REF [151TA3904](#) – Replacement lens

**TOTAL SOURCE®**

### REF [151TA3903](#) – 12V

- Technology: incandescent
- Mounting: 2 bolts
- Center distance: 240 mm
- Wire length: 145 mm
- Functions: rear, stop, turn, reverse
- Bulbs included

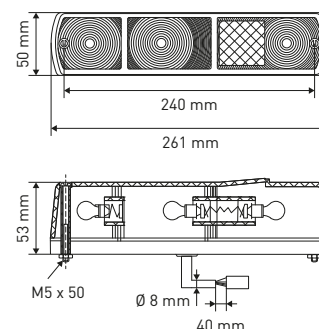

### REF [100TA2191](#) – Bulb: BA15S 12V 10W

### REF [101TA9495](#) – Bulb: BA15S 12V 25W

### REF [106TA4904](#) – Bulb: BAY15D 12V 23/8W

### REF [151TA3904](#) – Replacement lens

**TOTAL SOURCE®**



## REAR LIGHTS

**REF 151TA6046** – 12V

**REF 151TA6047** – 24V

- Technology: incandescent
- Mounting: 2 bolts
- Center distance: 230 mm
- Wire length: 235 mm
- Functions: rear, stop, turn, reverse
- Bulbs included
- Connector: M6

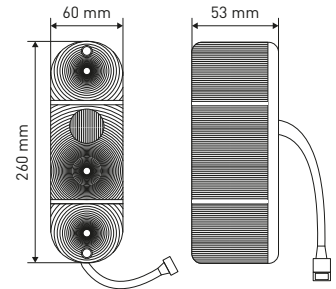

**REF 100TA2191** – Bulb: BA15S 12V 10W

**REF 100TA2216** – Bulb: BA15S 12V 23W

**REF 106TA4904** – Bulb: BAY15D 12V 23/8W

**REF 106TA4854** – Bulb: BA15S 24V 10W

**REF 100TA2219** – Bulb: BA15S 24V 25W

**REF 144TA5502** – Bulb: BAY15D 24V 25/10W

**REF 150TA4601** – Replacement lens

**TOTAL SOURCE®**

**REF 151TA3911** – 12V

**REF 151TA3912** – 24V

**REF 151TA3913** – 48V

- Technology: incandescent
- Mounting: 2 bolts
- Center distance: 250 mm
- Functions: rear, stop, turn, reverse
- Bulbs included
- Connector: B5, K1 built-in

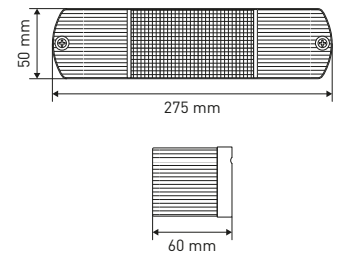

**REF 100TA2215** – Bulb: BA15S 12V 21W

**REF 123TA7988** – Bulb: BAY15D 12V 21/5W

**REF 100TA2218** – Bulb: BA15S 24V 21W

**REF 123TA7989** – Bulb: BAY15D 24V 21/5W

**REF 123TA7987** – Bulb: BA15S 48V 25W

**REF 123TA7990** – Bulb: BAT15D 48V 25/10W

**REF 150TA1302** – Replacement lens red

**REF 150TA1305** – Replacement lens white

**REF 150TA1304** – Replacement lens orange

**TOTAL SOURCE®**

**REF 151TA6101** – Without bulbs

**REF 151TA6100** – 12V

**REF 151TA6099** – 48V

- Technology: incandescent
- Mounting: 2 bolts
- Center distance: 253 mm
- Functions: rear, stop, turn, reverse
- Bulbs included
- Connector: B5, K1 built-in

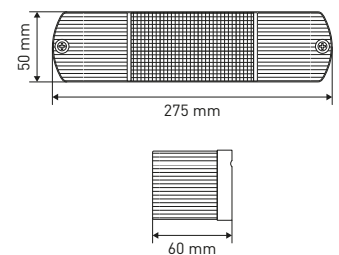

**REF 100TA2246** – Bulb: BAY15D 12V 21/5W

**REF 100TA2215** – Bulb: BA15S 12V 21W

**REF 144TA5468** – Bulb: BA15S 48V 25W

**REF 144TA5615** – Bulb: BAY15D 48V 25/10W

**REF 150TA2100** – Replacement lens kit

**TOTAL SOURCE®**





## REAR LIGHTS

- REF 151TA6011** – LH  
**REF 151TA6009** – RH
- Technology: incandescent
  - Mounting: 2 bolts
  - Center distance: 45 mm
  - 12–24V
  - Functions: rear, stop, turn
  - Bulbs not included

- REF 103TA4596** – Bulb: BA15S 12V 10W  
**REF 122TA9113** – Bulb: BA15S 12V 21W  
**REF 106TA4860** – Bulb: BA15S 24V 10W  
**REF 103TA4603** – Bulb: BA15S 24V 21W  
**REF 151TA6109** – Replacement lens LH  
**REF 151TA6110** – Replacement lens RH



LH

RH

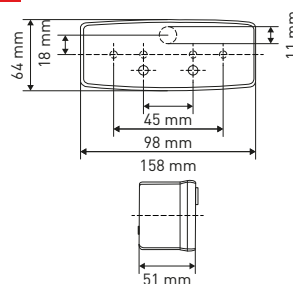

E-approved

- REF 151TA6020** – 12V  
**REF 151TA6021** – 24V with AMP-connector
- Technology: incandescent
  - Mounting: 2 bolts
  - Center distance: 57 mm
  - Functions: rear, stop, reverse
  - Bulbs included

- REF 123TA7988** – Bulb: BAY15D 12V 21/5W  
**REF 122TA9113** – Bulb: BA15S 12V 21W  
**REF 100TA2249** – Bulb: BAY15D 24V 21/5W  
**REF 103TA4603** – Bulb: BA15S 24V 21W  
**REF 150TA2229** – Replacement lens

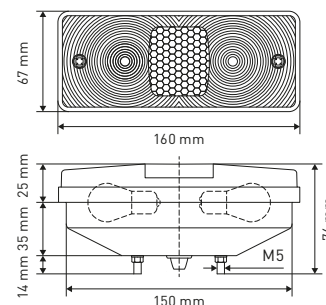

E-approved

- REF 151TA5938** – 12V  
**REF 151TA5939** – Without bulbs
- Technology: incandescent
  - Mounting: 2 bolts
  - Center distance: 57 mm
  - Functions: rear, stop, turn

- REF 103TA4621** – Bulb: BAY15D 12V 21/5W  
**REF 100TA2215** – Bulb: BA15S 12V 21W

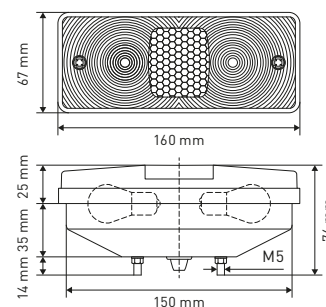

E-approved



## REAR LIGHTS

- REF 151TA6005** – LH  
**REF 151TA6006** – RH
- Technology: incandescent
  - Mounting: 2 bolts
  - Center distance: 70 mm
  - 12–24V
  - Functions: rear, stop, turn
  - Bulbs not included



LH



RH

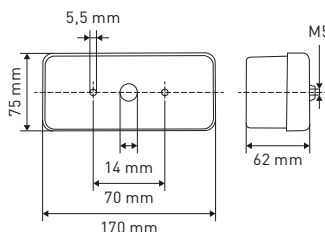

- REF 103TA4596** – Bulb: BA15S 12V 10W  
**REF 122TA9113** – Bulb: BA15S 12V 21W  
**REF 106TA4860** – Bulb: BA15S 24V 10W  
**REF 103TA4603** – Bulb: BA15S 24V 21W  
**REF 151TA6007** – Replacement lens LH  
**REF 151TA6008** – Replacement lens RH



E-approved

- REF 151TA6032** – 24V
- Technology: incandescent
  - Mounting: 2 bolts
  - Center distance: 134 mm
  - Wire length: 150 mm
  - Functions: rear, stop, reverse
  - Bulbs included
  - Connector: K4

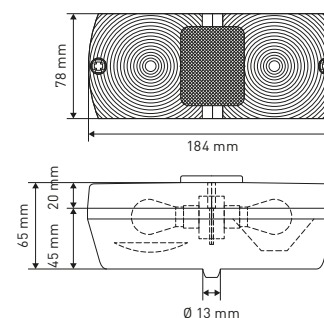

- REF 103TA4603** – Bulb: BA15S 24V 21W  
**REF 100TA2249** – Bulb: BAY15D 24V 21/5W  
**REF 150TA2230** – Replacement lens



E-approved

- REF 151TA6012**
- Technology: incandescent
  - Mounting: 2 bolts
  - Center distance: 134 mm
  - 12V
  - Functions: rear, stop, reverse
  - Bulbs not included

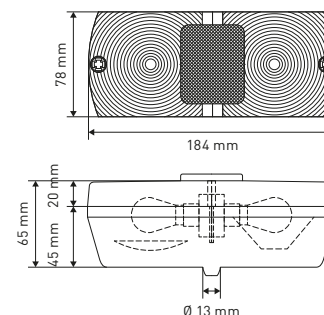

- REF 100TA2215** – Bulb: BA15S 12V 21W  
**REF 100TA2246** – Bulb: BAY15D 12V 21/5W  
**REF 103TA4603** – Bulb: BA15S 24V 21W  
**REF 100TA2249** – Bulb: BAY15D 24V 21/5W  
**REF 151TA6014** – Replacement lens  
**REF 151TA6013** – Bracket



E-approved



## REAR LIGHTS

- REF 151TA6022** – 12V with wire length: 200 mm  
**REF 151TA6023** – 12V with wire length: 640 mm
- Technology: incandescent
  - Mounting: 2 bolts
  - Center distance: 134 mm
  - Functions: rear, stop, turn
  - Bulbs included
  - Connector: H4

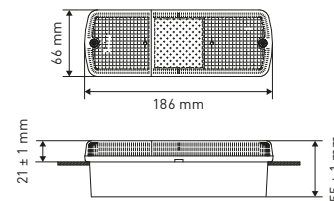

- REF 100TA2246** – Bulb: BAY15D 12V 21/5W  
**REF 100TA2215** – Bulb: BA15S 12V 21W  
**REF 127TA2919** – Replacement lens

E-approved

**TOTAL SOURCE®**

- REF 151TA5976** – 12V LH with fog  
**REF 151TA5975** – 12V LH with reverse  
**REF 151TA5977** – 12V RH

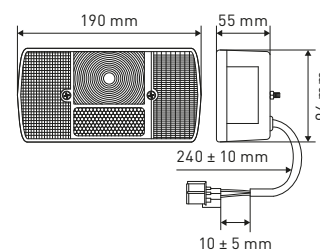

- REF 100TA2215** – Bulb: BA15S 12V 21W  
**REF 100TA2246** – Bulb: BAY15D 12V 21/5W  
**REF 150TA4542** – Replacement lens LH  
**REF 150TA4543** – Replacement lens RH

E-approved

**TOTAL SOURCE®**

- REF 151TA6080** – LH  
**REF 151TA6079** – RH
- Technology: incandescent
  - Mounting: 2 bolts
  - Center distance: 55 mm
  - 12–24V
  - Functions: rear, stop, turn, reverse, license
  - Bulbs not included

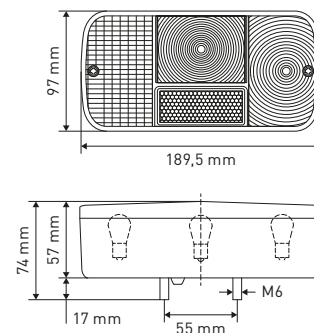

- REF 100TA2246** – Bulb: BAY15D 12V 21/5 W  
**REF 100TA2215** – Bulb: BA15S 12V 21W  
**REF 103TA4603** – Bulb: BA15S 24V 21W  
**REF 100TA2249** – Bulb: BAY15D 24V 21/5W  
**REF 150TA4542** – Replacement lens LH  
**REF 150TA4706** – Replacement lens RH

E-approved

**COBO®**  
*group*



## REAR LIGHTS

**REF 151TA6087** – LH

**REF 151TA6088** – RH

- Technology: incandescent
- Mounting: 2 bolts
- Center distance: 55 mm
- Wire length: 315 mm
- 12-24V
- Functions: rear, stop, turn, reverse
- Bulbs not included
- Connector: P6

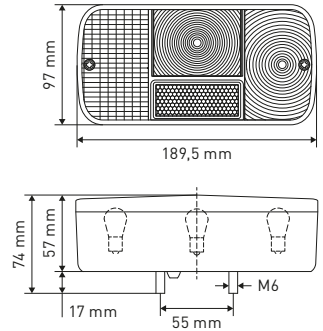

**REF 100TA2246** – Bulb: BAY15D 12V 21/5 W

**REF 100TA2215** – Bulb: BA15S 12V 21W

**REF 103TA4603** – Bulb: BA15S 24V 21W

**REF 100TA2249** – Bulb: BAY15D 24V 21/5W

**REF 150TA4542** – Replacement lens LH

**REF 150TA4706** – Replacement lens RH



**E-approved**

**REF 151TA6024** – 12V

- Technology: incandescent
- Mounting: 2 bolts
- Center distance: 154 mm
- Functions: rear, stop, turn
- Bulbs included

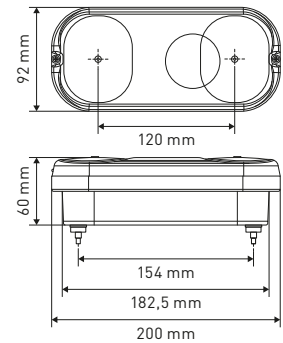

**REF 100TA2246** – Bulb: BAY15D 12V 21/5 W

**REF 100TA2215** – Bulb: BA15S 12V 21W

**REF 151TA6025** – Replacement lens



**E-approved**

**REF 151TA5945** – 12V

- Technology: incandescent
- Mounting: 2 bolts
- Center distance: 177 mm
- Wire length: 160 mm
- Functions: rear, stop, turn, reverse
- Bulbs included
- Connector: H6

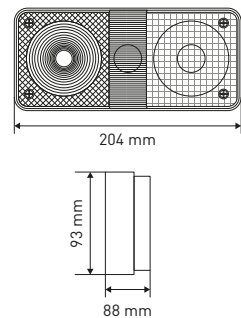

**REF 106TA1277** – Bulb: BA15S 12V 10W

**REF 123TA7988** – Bulb: BAY15D 12V 21/5 W





## REAR LIGHTS

**REF 151TA6089** – 12V LH

**REF 151TA6090** – 12V RH with back-up light

- Technology: incandescent
- Mounting: 2 bolts
- Center distance: 152 mm
- Functions: rear, stop, turn, reverse
- Bulbs included
- Connector: J6

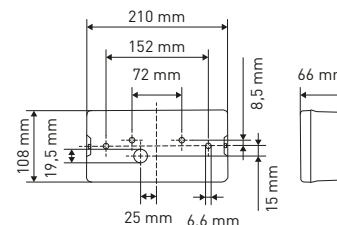

**REF 103TA4596** – Bulb: BA15S 12V 10W

**REF 100TA2215** – Bulb: BA15S 12V 21W

**E-approved**



**REF 151TA6082** – LH

- Technology: incandescent
- Mounting: 2 bolts
- Center distance: 152 mm
- 12–24V
- Functions: rear, stop, turn, reverse
- Bulbs not included

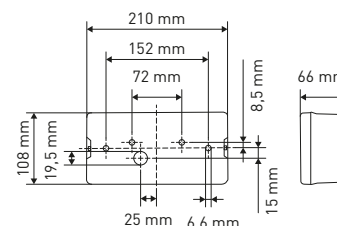

**REF 103TA4596** – Bulb: BA15S 12V 10W

**REF 100TA2215** – Bulb: BA15S 12V 21W

**REF 106TA4860** – Bulb: BA15S 24V 10W

**REF 103TA4603** – Bulb: BA15S 24V 21W

**E-approved**



**REF 151TA6062** – LH

**REF 151TA6063** – RH

- Technology: incandescent
- Mounting: 2 bolts
- Center distance: 152 mm
- 12–24V
- Functions: rear, stop, turn, fog
- Bulbs not included

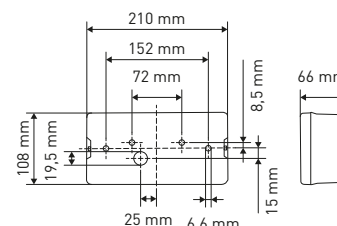

**REF 103TA4596** – Bulb: BA15S 12V 10W

**REF 100TA2215** – Bulb: BA15S 12V 21W

**REF 106TA4860** – Bulb: BA15S 24V 10W

**REF 103TA4603** – Bulb: BA15S 24V 21W

**REF 151TA6083** – Replacement lens LH

**REF 151TA6065** – Replacement lens RH

**E-approved**





## REAR LIGHTS

- REF 151TA6086** – 24V without wire  
**REF 151TA6085** – 24V wire length: 910 mm
- Technology: incandescent
  - Mounting: 2 bolts
  - Center distance: 155 mm
  - Functions: rear, stop, turn, reverse,
  - Bulbs included
  - Used for Hyster and Yale
  - Connector: D6

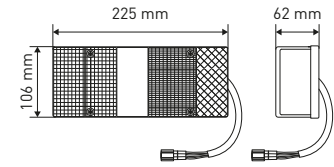

- REF 100TA2209** – Bulb: BA15S 24V 5W  
**REF 100TA2218** – Bulb: BA15S 24V 21W (3x)

**E-approved**

**TOTAL SOURCE®**

- REF 151TA6103** – 12V LH  
**REF 151TA6102** – 12V RH
- Technology: incandescent
  - Mounting: 2 bolts
  - Center distance: 49 mm
  - Functions LH: rear, stop, turn, fog
  - Functions RH: rear, stop, turn, reverse
  - Bulbs included
  - Connector: D6 built-in

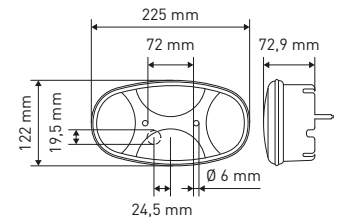

- REF 103TA4596** – Bulb: BA15S 12V 10W  
**REF 100TA2215** – Bulb: BA15S 12V 21W  
**REF 151TA6105** – Replacement lens LH  
**REF 151TA6104** – Replacement lens RH

**E-approved**



- REF 151TA6034** – 12V LH  
**REF 151TA6035** – 12V RH + reverse
- Technology: incandescent
  - Mounting: 2 bolts
  - Center distance: 152 mm
  - Functions: rear, stop, turn, fog, license
  - Bulbs included
  - Connector: C6 built-in

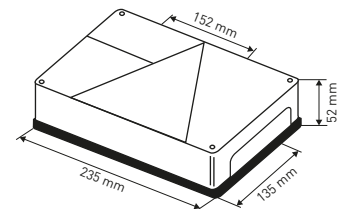

- REF 100TA2246** – Bulb: BAY15D 12V 21/5W  
**REF 100TA2215** – Bulb: BA15S 12V 21W  
**REF 100TA2218** – Bulb: BA15S 24V 21W (3x)  
**REF 150TA4720** – Replacement lens RH

**E-approved**

**TOTAL SOURCE®**



## REAR LIGHTS

**REF 151TA6093** – 12V LH

**REF 151TA6094** – 12V RH

- Technology: incandescent
- Mounting: 2 bolts
- Center distance: 152 mm
- Functions: rear, stop, turn, reverse, fog, license, reflector triangle
- Bulbs included
- Connector: A8

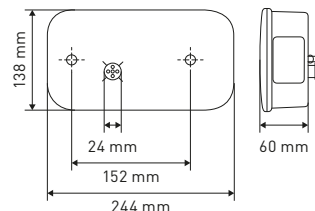

**REF 100TA2118** – Bulb: SV 8,5-8 12V 5W

**REF 100TA2215** – Bulb: BA15S 12V 21W

**REF 123TA7988** – Bulb: BAY15D 12V 21/5W

E-approved

**TOTAL SOURCE**<sup>®</sup>

**REF 151TA6084** – 12V

- Technology: incandescent
- Mounting: 2 bolts
- Center distance: 152 mm
- Functions: rear, stop, turn, reverse, fog
- Bulbs included
- Connector: E6 & E2

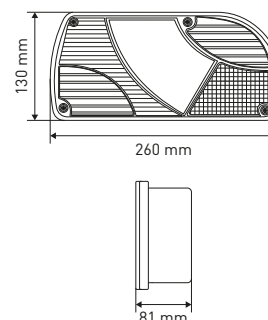

**REF 115TA4602** – Bulb: BA15S 12V 5W

**REF 140TA8980** – Bulb: BAU15S 12V 21W orange

**REF 100TA2215** – Bulb: BA15S 12V 21W

**REF 150TA6357** – Replacement lens

E-approved

**COBO**<sup>®</sup>  
*group*

**REF 151TA6091** – 12V LH

**REF 151TA6094** – 12V RH

- Technology: incandescent
- Mounting: 4 bolts
- Center distance: 190 mm
- Functions: rear, stop, turn, fog
- Bulbs included
- Connector: Q6

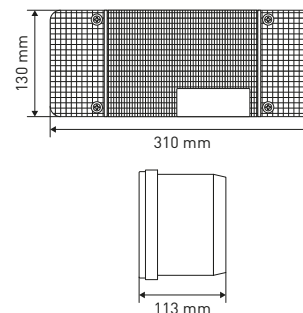

**REF 161TA6075** – Bulb: BA15S 12V 5W

**REF 100TA2215** – Bulb: BA15S 12V 21W

**REF 150TA4540** – Replacement lens

E-approved

**COBO**<sup>®</sup>  
*group*



## REAR LIGHTS

**REF 151TA6049** – LH

**REF 151TA6048** – RH

- Technology: incandescent
- Mounting: 2 bolts
- Center distance: 152 mm
- 12–24V
- Functions: rear, stop, turn, reverse, fog
- Bulbs not included

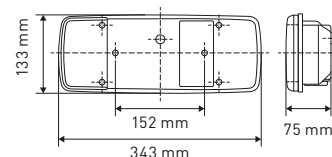

**REF 103TA4596** – Bulb: BA15S 12V 10W

**REF 100TA2215** – Bulb: BA15S 12V 21W

**REF 100TA2195** – Bulb: BA15S 24V 10W

**REF 100TA2218** – Bulb: BA15S 24V 21W

**REF 150TA5799** – Replacement lens



**E-approved**

**REF 151TA6018**

- Technology: incandescent
- Mounting: 2 bolts
- Center distance: 152 mm
- 12–24V
- Functions: rear, stop, turn, reverse, fog
- Bulbs not included

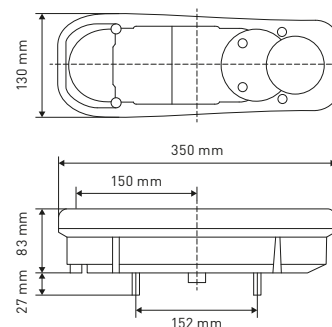

**REF 103TA4596** – Bulb: BA15S 12V 10W

**REF 100TA2215** – Bulb: BA15S 12V 21W

**REF 106TA4860** – Bulb: BA15S 24V 10W

**REF 103TA4603** – Bulb: BA15S 24V 21W

**REF 151TA6019** – Replacement lens

**E-approved**

**TOTAL SOURCE®**

**REF 151TA6042** – 12V

- Technology: incandescent
- Mounting: internal
- Functions: rear, stop, reverse
- Bulbs included

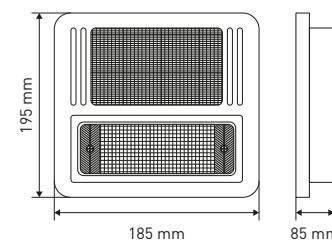

**REF 142TA1296** – Bulb: W2.1x9.5D 12V 10W

**REF 100TA2215** – Bulb: BA15S 12V 21W

**REF 151TA6043** – Replacement lens red

**TOTAL SOURCE®**





## REAR LIGHTS

### REF 151TA6004 – 24V

- Technology: LED
- Mounting: 2 bolts
- Center distance: 80 mm
- Wire length: 260 mm
- Function: rear
- Connector: G2

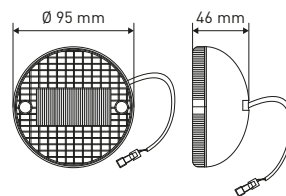

E-approved

**TOTAL SOURCE**<sup>®</sup>  
BRAND: JOKON

### REF 151TA5960 – 12V without connector

### REF 151TA5959 – 12V with connector K4

- Technology: LED
- Mounting: 2 bolts
- Center distance: 45 mm
- Wire length: 230 mm
- Functions: rear, turn, stop

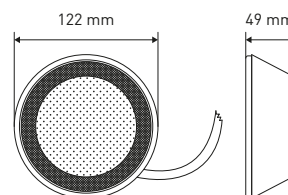

E-approved

**TOTAL SOURCE**<sup>®</sup>

### REF 163TA8807 – 10-24V

- Technology: LED
- Mounting: 2 bolts
- Center distance: 45 mm
- Functions: rear, stop, turn

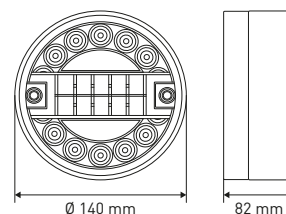

E-approved

**TOTAL SOURCE**<sup>®</sup>



## REAR LIGHTS

- REF 151TA5962** – 24V without connector
- REF 151TA5961** – 24V with Deutsch connector A4
- REF 151TA5963** – 12–24V without connector
- Technology: LED
- Mounting: 2 bolts
- Center distance: 45 mm
- Wire length: 280 mm
- Functions: rear, stop, turn

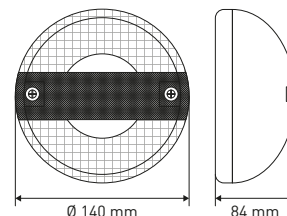

**E-approved**

**TOTAL SOURCE®**

- REF 151TA5984** – 12V
- Technology: incandescent
- Mounting: internal
- Wire length: 250 mm
- Functions: rear, stop
- Bulb not included

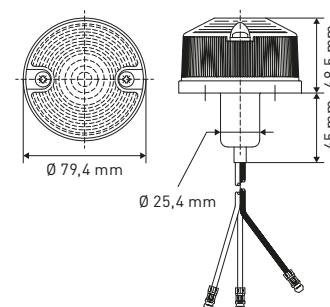

- REF 100TA2246** – Bulb: BAY15D 12V 21/5W
- REF 150TA5235** – Replacement lens

**E-approved**

**TOTAL SOURCE®**

BRAND: BRITAX

- REF 151TA5982**
- Technology: incandescent
- Mounting: 2 bolts
- Center distance: 45 mm
- 12–24V
- Functions: rear
- Bulb not included

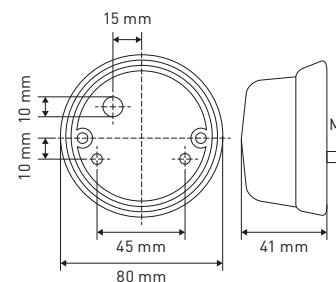

Amber version, see page 43 (REF 151TA3944)  
Green version, see page 155 (REF 151TA3265)

- REF 100TA2126** – Bulb: SV8,5-8 12V 18W
- REF 106TA4833** – Bulb: SV8,5-8 24V 18W

**E-approved**





## REAR LIGHTS

### REF 151TA5950

- Technology: incandescent
- Mounting: 2 bolts
- Center distance: 45 mm
- 12V
- Functions: rear, stop, turn
- Bulbs not included

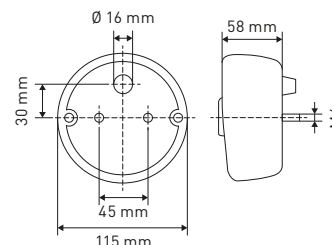

REF 106TA4831 – Bulb: SV 8,5-8 12V 10W

REF 151TA3266 – Bulb: SV 8,5-8 12V 18W

REF 151TA5949 – Replacement lens



E-approved

### REF 151TA5948 – 12V

### REF 151TA5947 – 24V

- Technology: incandescent
- Mounting: 2 bolts
- Center distance: 45 mm
- Wire length: 490 mm
- Functions: rear, stop, turn
- Bulbs included

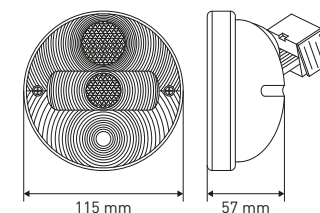

REF 106TA4831 – Bulb: SV 8,5-8 12V 10W

REF 106TA4896 – Bulb: S8,5 12V 21W

REF 106TA4907 – Bulb: SV8,5-8 24V 10W

REF 106TA4833 – Bulb: SV8,5-8 24V 18W

REF 151TA5949 – Replacement lens



### REF 151TA5979

REF 151TA5980 – 24V with bulbs wire length: 390 mm

REF 151TA5981 – 12V bulb included

- Technology: incandescent
- Mounting: 2 bolts
- Center distance: 45 mm
- Functions: rear, stop, turn, reverse
- No bulbs included

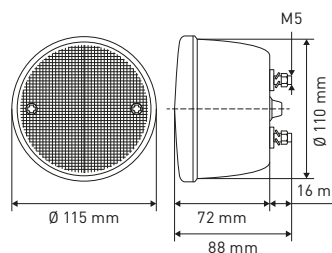

REF 100TA2215 – Bulb: BA15S 12V 21W

REF 103TA4621 – Bulb: BAY15D 12V 21/5W

REF 103TA4603 – Bulb: BA15S 24V 21W

REF 106TA4875 – Bulb: BAY15D 24V 21/5W

REF 150TA4704 – Replacement lens



E-approved



## REAR LIGHTS

- REF 151TA6061** – 12V without cable  
**REF 151TA6060** – 12V wire length: 390 mm  
**REF 151TA5946** – 24V wire length: 210 mm
- Technology: incandescent
  - Mounting: 2 bolts
  - Center distance: 45 mm
  - Functions: rear, stop, turn
  - Bulbs included

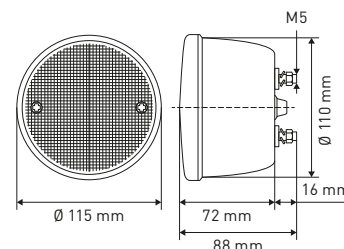

- REF 106TA4831** – Bulb: SV 8,5-8 12V 10W  
**REF 100TA2215** – Bulb: BA15S 12V 21W  
**REF 106TA4907** – Bulb: SV8,5-8 24V 10W  
**REF 103TA4603** – Bulb: BA15S 24V 21W  
**REF 150TA3405** – Replacement lens



E-approved

- REF 151TA5954**
- Technology: incandescent
  - Mounting: 2 bolts
  - Center distance: 45 mm
  - 12–24V
  - Functions: rear, stop, turn
  - Bulbs not included

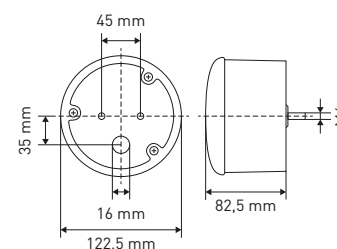

- REF 100TA2215** – Bulb: BA15S 12V 21W  
**REF 123TA7988** – Bulb: BAY15D 12V 21/5 W  
**REF 103TA4603** – Bulb: BA15S 24V 21W  
**REF 123TA7989** – Bulb: BAY15D 24V 21/5W  
**REF 151TA5955** – Replacement lens



E-approved

- REF 151TA5952** – Without license function  
**REF 151TA5953** – Including license function
- Technology: incandescent
  - Mounting: 2 bolts
  - Center distance: 45 mm
  - 12–24V
  - Functions: rear, stop, turn
  - Bulbs not included

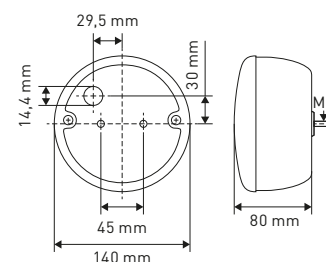

- REF 115TA4602** – Bulb: BA15S 12V 5W  
**REF 100TA2215** – Bulb: BA15S 12V 21W  
**REF 103TA4597** – Bulb: BA15S 24V 5W  
**REF 115TA4603** – Bulb: BA15S 24V 21W  
**REF 144TA1688** – Replacement lens



E-approved



## REAR LIGHTS

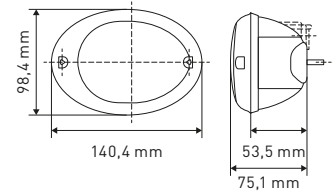

**REF 151TA6078** – 12V

- Technology: incandescent
- Mounting: 2 bolts
- Center distance: 45 mm
- Functions: rear, stop, turn
- Bulbs included

**REF 100TA2215** – Bulb: BA15S 12V 21W



E-approved

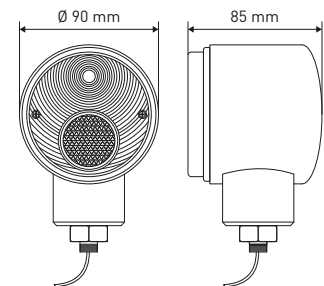

**REF 151TA5951** – 24V

- Technology: incandescent
- Mounting: single bolt
- Wire length: 90 mm
- Functions: rear, stop
- Bulbs included
- Used for Nissan

**REF 100TA2249** – Bulb: BAY15D 24V 21/5W

**REF 151TA3951** – Replacement lens back

**REF 150TA1099** – Replacement lens front

**TOTAL SOURCE**®



## BUILT-IN

**REF 151TA6037** – LH

**REF 151TA6038** – RH

- Technology: incandescent
- Mounting: internal
- 24V
- Functions: rear, stop, turn, reverse
- Bulbs not included

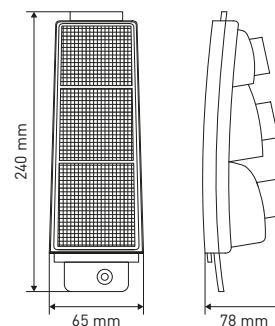

**REF 144TA5560** – Bulb: BAU15S 24V 21W orange

**REF 123TA7989** – Bulb: BAY15D 24V 21/5W

E-approved



**REF 151TA6074** – 12V

- Technology: incandescent
- Mounting: internal
- Wire length: 500 mm
- Functions: rear, stop, turn, reverse
- Bulbs included
- Connector: O6

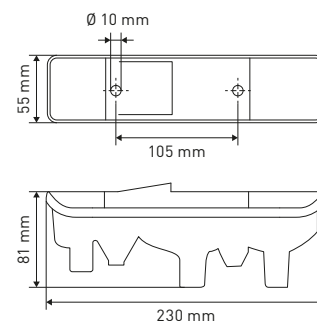

**REF 151TA5944** – Bulb: BA15S 12V 10W

**REF 100TA2215** – Bulb: BA15S 12V 21W

**REF 123TA7988** – Bulb: BAY15D 12V 21/5W

**REF 151TA6075** – Replacement lens orange

**REF 151TA6076** – Replacement lens red

**REF 151TA6077** – Replacement lens white

**TOTAL SOURCE®**

**REF 151TA6067** – 12V

**REF 151TA6068** – 48V

- Technology: incandescent
- Mounting: internal
- Functions: rear, stop, turn, reverse
- Bulbs included
- Connector: I3+J2

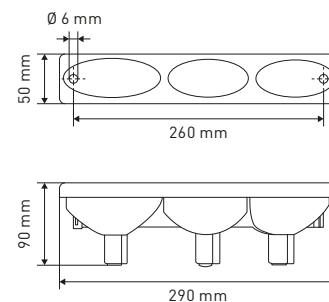

**REF 103TA4586** – Bulb: BA15S 12V 10W

**REF 103TA4602** – Bulb: BA15S 12V 25W

**REF 103TA4621** – Bulb: BAY15D 12V 21/5W

**REF 161TA6024** – Bulb: BA15S 48V 10W

**REF 144TA5468** – Bulb: BA15S 48V 25W

**REF 106TA4877** – Bulb: BAY15D 48V 25/10W

**REF 151TA6069** – Replacement lens

**TOTAL SOURCE®**



## BUILT-IN

- REF 151TA5940** – 12V LH  
**REF 151TA5941** – 12V RH
- Technology: incandescent
  - Mounting: internal 4 bolts
  - Center distance: 98 mm
  - Wire length: 345 mm
  - Functions: rear, stop, turn
  - Bulbs included
  - Connector: M4

- REF 151TA5944** – Bulb: BA15S 12V 10W  
**REF 100TA2246** – Bulb: BAY15D 12V 21/5 W  
**REF 151TA5942** – Replacement lens

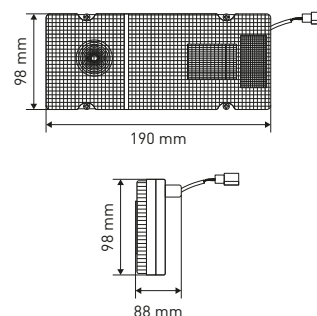

**TOTAL SOURCE®**

- REF 151TA6017** – 12V LH  
**REF 151TA6016** – 12V RH
- Technology: incandescent
  - Mounting: internal
  - Wire length: 310 mm
  - Functions: rear, stop, turn
  - Connector: I4

- REF 106TA1277** – Bulb: BA15S 12V 10W  
**REF 123TA7988** – Bulb: BAY15D 12V 21/5W  
**REF 150TA5353** – Replacement lens

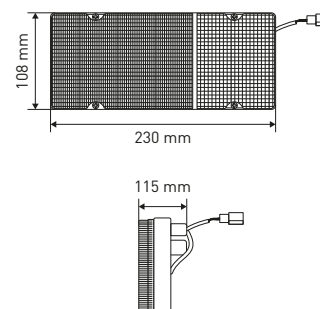

**TOTAL SOURCE®**

- REF 151TA5936** – 24V LH  
**REF 151TA5937** – 24V RH
- Technology: incandescent
  - Mounting: internal
  - Wire length: 800 mm
  - Functions: rear, stop, turn, reverse
  - Bulbs included
  - Connector: H6

- REF 103TA4603** – Bulb: BA15S 24V 21W  
**REF 123TA7989** – Bulb: BAY15D 24V 21/5W  
**REF 150TA2553** – Replacement lens LH  
**REF 150TA2552** – Replacement lens RH

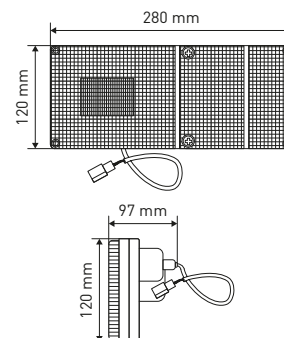

**TOTAL SOURCE®**

E-approved



## BUILT-IN

**REF 151TA6108** – 24V LH

**REF 151TA6107** – 24V RH

- Technology: incandescent
- Mounting: internal
- Functions: rear, stop, turn, reverse
- Bulbs included

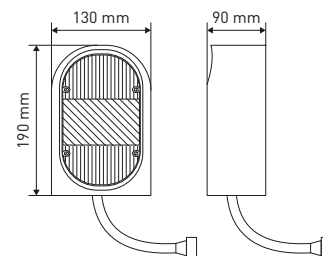

**REF 100TA2249** – Bulb: BAY15D 24V 21/5W

**REF 100TA2218** – Bulb: BA15S 24V 21W

**REF 140TA8979** – Bulb: BAU15S 24V 21W orange

**REF 150TA3112** – Replacement lens

E-approved

**TOTAL SOURCE**<sup>®</sup>

**REF 151TA6072** – 12V LH

**REF 151TA6073** – 12V RH

- Technology: incandescent
- Mounting: internal
- Functions: rear, stop, turn
- Bulbs included

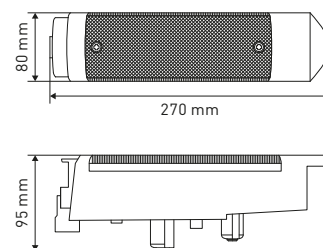

**REF 100TA2246** – Bulb: BAY15D 12V 21/5W

**REF 100TA2215** – Bulb: BA15S 12V 21W

**REF 150TA3718** – Replacement lens kit LH

**REF 150TA9423** – Replacement lens kit RH

**TOTAL SOURCE**<sup>®</sup>

**REF 151TA5934** – 12V LH

**REF 151TA5935** – 12V RH

**REF 151TA5932** – 48V LH

**REF 151TA5933** – 48V RH

- Technology: incandescent
- Mounting: internal
- Wire length: 210 mm
- Functions LH: rear, stop, turn
- Functions RH: rear, stop, turn, reverse
- Bulbs included
- Used for Toyota 7-series (light grey housing)

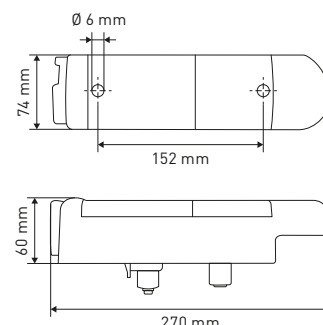

**REF 106TA1277** – Bulb: BA15S 12V 10W

**REF 100TA2246** – Bulb: BAY15D 12V 21/5W

**REF 144TA5468** – Bulb: BA15S 48V 25W

**REF 123TA7990** – Bulb: BAY15D 48V 25/10W

**REF 151TA5929** – Replacement lens amber

**REF 151TA5930** – Replacement lens red

**REF 151TA5931** – Replacement lens white

**TOTAL SOURCE**<sup>®</sup>





## BUILT-IN

- REF [151TA5927](#) – 12V LH
- REF [151TA5928](#) – 12V RH
- REF [151TA5925](#) – 48V LH
- REF [151TA5926](#) – 48V RH
- Technology: incandescent
- Mounting: internal
- Functions LH: rear, stop, turn
- Functions RH: rear, stop, turn, reverse
- Bulbs included
- Used for Toyota 7-series (dark grey housing)

- REF [106TA1277](#) – Bulb: BA15S 12V 10W
- REF [100TA2246](#) – Bulb: BAY15D 12V 21/5W
- REF [144TA5468](#) – Bulb: BA15S 48V 25W
- REF [123TA7990](#) – Bulb: BAY15D 48V 25/10W
- REF [151TA5929](#) – Replacement lens amber
- REF [151TA5930](#) – Replacement lens red
- REF [151TA5931](#) – Replacement lens white



LH



RH

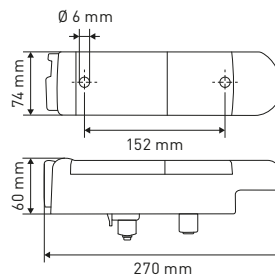

**TOTAL SOURCE®**

- REF [151TA6044](#) – 12V
- REF [151TA6045](#) – 12V with fog lamp
- Technology: incandescent
- Mounting: 2 bolts
- Center distance: 222 mm
- Functions: rear, stop, turn, reverse
- Bulbs included
- Connector: C6

- REF [100TA2215](#) – Bulb: BA15S 12V 21W
- REF [123TA7988](#) – Bulb: BAY15D 12V 21/5 W
- REF [141TA1566](#) – Replacement lens white
- REF [150TA6250](#) – Replacement lens red
- REF [161TA6000](#) – Replacement lens orange

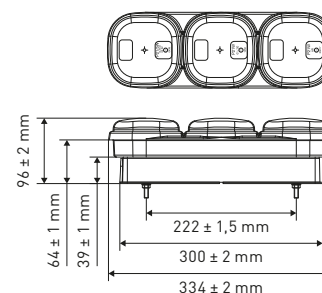

E-approved

**TOTAL SOURCE®**



## REAR RAMP

### REF 150TA9504 – 12V

- Technology: LED
- Mounting: 2 bolts
- Center distance 790 mm
- Wire length: 4000 mm with male plug with 7 plastic road studs
- Functions: rear, stop, turn, license, reflector and triangle reflector
- Certified CE E11



E-approved

**TOTAL SOURCE**<sup>®</sup>



# REFLECTORS



## NICE TO KNOW – REFLECTORS

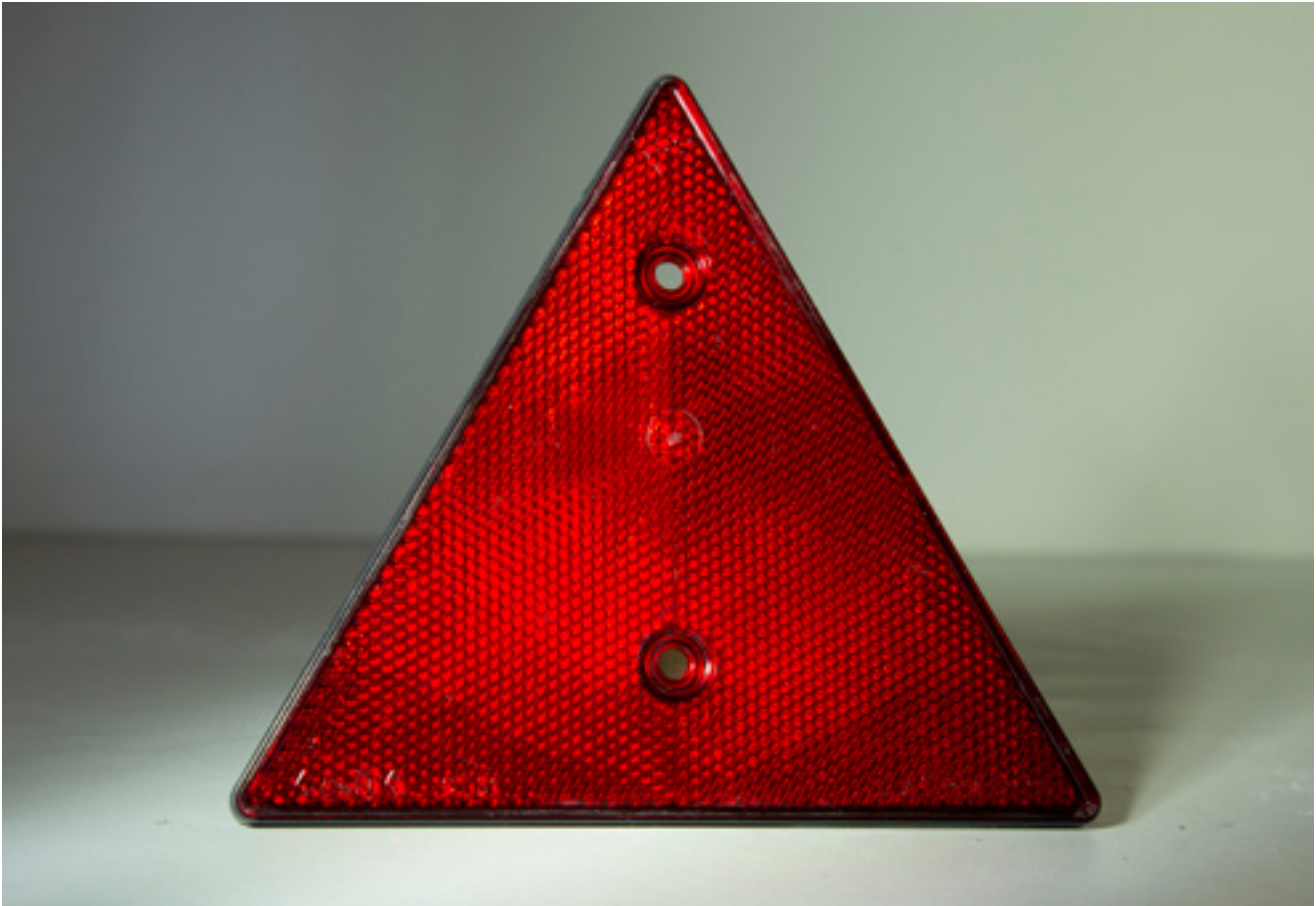

A reflector reflects the incoming light in the same direction. This way, lights of surrounding vehicles can make even a stationary vehicle visible in the dark.

Reflectors exist in a number of different colours and shapes. The installation is done by means of stickers or bolts, depending on the model.

In certain countries it is mandatory to attach a reflective triangle to the back of the vehicle in case of use on public roads. Depending on the country, this reflector must be part of the rear light or it can be attached to the back of the vehicle as a separate reflector. The road regulations of the country in question must be observed in this case.



## REFLECTORS

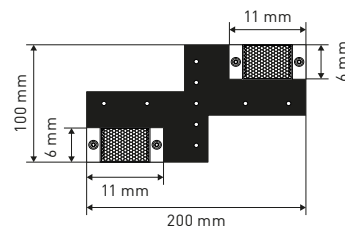

### REF 150TA7927

- Colour: white
- Shape: mainly rectangular/square
- Mounting: screws
- Center distance: 180 mm
- Spare reflectors (REF 150TA7930)

**TOTAL SOURCE**<sup>®</sup>

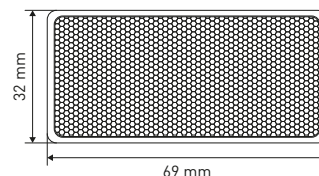
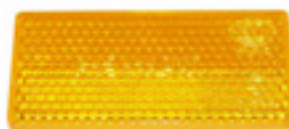

### REF 150TA7838

- Colour: orange
- Shape: rectangular
- Mounting: adhesive



**E-approved**

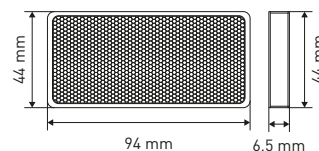

### REF 150TA7837

- Colour: orange
- Shape: rectangular
- Mounting: adhesive

**TOTAL SOURCE**<sup>®</sup>

**E-approved**

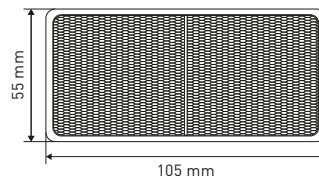

### REF 150TA8456

- Colour: orange
- Shape: rectangular
- Mounting: adhesive

**TOTAL SOURCE**<sup>®</sup>

**E-approved**



## REFLECTORS

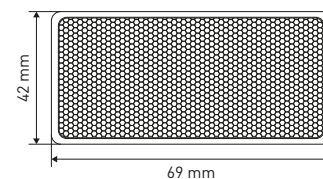

**REF 150TA7518**

- Colour: red
- Shape: rectangular
- Mounting: adhesive

**E-approved**

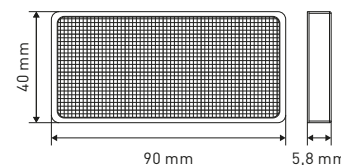

**REF 152TA1646**

- Colour: red
- Shape: rectangular
- Mounting: adhesive

**E-approved**

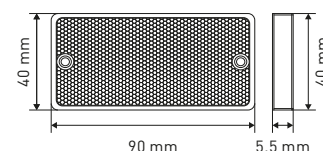

**REF 150TA7958**

- Colour: orange
- Shape: rectangular
- Mounting: screws
- Center distance: 79 mm

**E-approved**

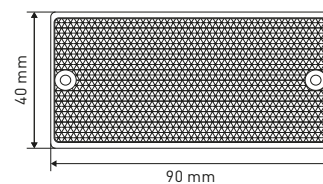

**REF 150TA7948**

- Colour: red
- Shape: rectangular
- Mounting: screws/adhesive
- Center distance: 79 mm

**E-approved**





## REFLECTORS

### REF 150TA8502

- Colour: red
- Shape: rectangular
- Mounting: screws
- Center distance: 70 mm

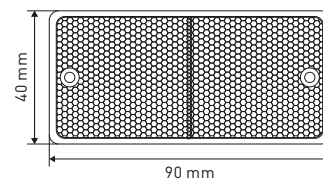

E-approved

**TOTAL SOURCE**<sup>®</sup>

### REF 150TA8400

- Colour: white
- Shape: rectangular
- Mounting: screws
- Center distance: 70 mm

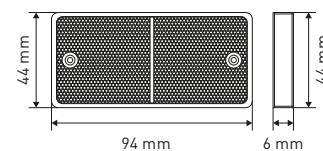
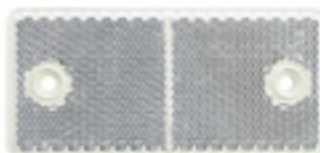

E-approved



### REF 152TA1649

- Colour: white
- Shape: rectangular
- Mounting: screws
- Center distance: 70 mm

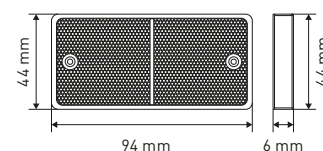
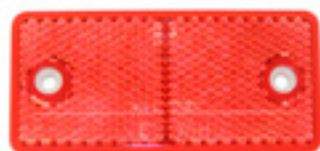

E-approved



### REF 150TA7770

- Colour: red
- Shape: rectangular
- Mounting: screws
- Center distance: 45,5 mm
- Used on Deutz

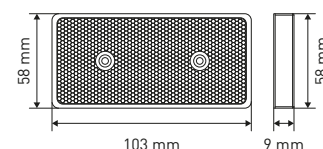

E-approved

**TOTAL SOURCE**<sup>®</sup>



## REFLECTORS

### REF 150TA7144

- Colour: red
- Shape: rectangular
- Mounting: one central screw M6
- Used on Nissan

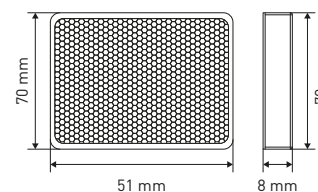

E-approved

**TOTAL SOURCE**<sup>®</sup>

### REF 150TA9071

- Colour: red
- Shape: rectangular
- Mounting: screws M4
- Center distance: 50 mm

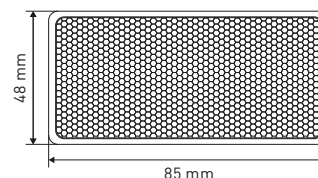

E-approved

**TOTAL SOURCE**<sup>®</sup>

### REF 150TA7954

- Colour: red
- Shape: rectangular
- Mounting: screws
- Center distance: 115 mm

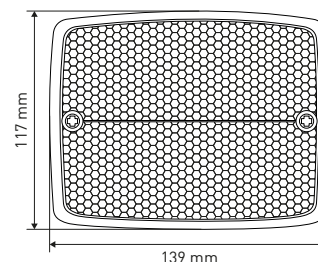

E-approved

**TOTAL SOURCE**<sup>®</sup>

### REF 150TA7055

- Colour: white
- Shape: rectangular
- Mounting: adhesive

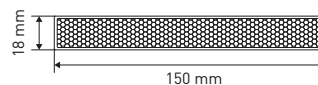





## REFLECTORS

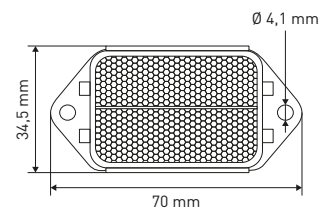

**REF 150TA7796**

- Colour: white
- Shape: rectangular
- Mounting: 2 screws
- Center distance: 60 mm

**TOTAL SOURCE®**

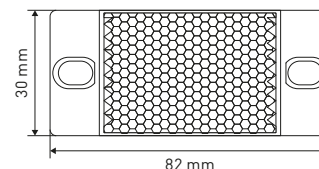

**REF 150TA7930**

- Colour: white
- Shape: rectangular
- Mounting: 2 screws
- Center distance: 69,5 mm

**TOTAL SOURCE®**

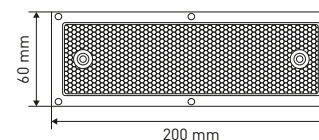

**REF 150TA7798**

- Colour: white
- Shape: rectangular
- Mounting: screws
- Center distance: 192 mm

**TOTAL SOURCE®**

**E-approved**

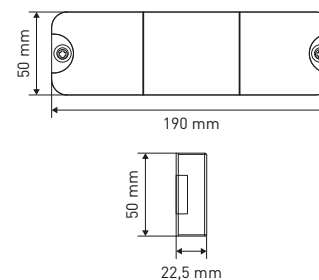

**REF 150TA7044**

- Colour: red
- Shape: rectangular
- Mounting: screws
- Center distance: 174 mm

**TOTAL SOURCE®**



## REFLECTORS

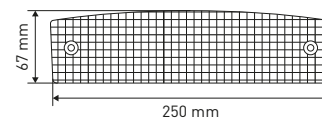

**REF 150TA7520**

- Colour: red
- Shape: rectangular
- Mounting: screws
- Center distance: 210 mm

**TOTAL SOURCE®**

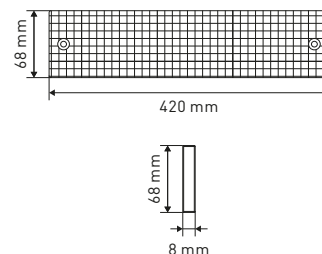

**REF 152TA1647**

- Colour: red
- Shape: rectangular
- Mounting: screws
- Center distance: 378 mm

**TOTAL SOURCE®**

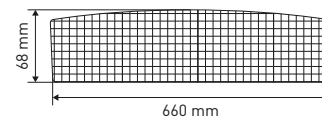

**REF 150TA7521**

- Colour: red
- Shape: rectangular
- Mounting: internal

**TOTAL SOURCE®**

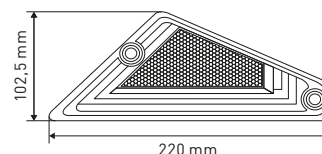

**REF 150TA8911 – LH**

**REF 150TA8910 – RH**

- Colour: red
- Shape: special
- Mounting: screws
- Center distance: 147 mm

**E-approved**

**TOTAL SOURCE®**



## REFLECTORS

### REF 150TA8808

- Colour: red
- Shape: triangular
- Mounting: screws
- center distance: 70 mm

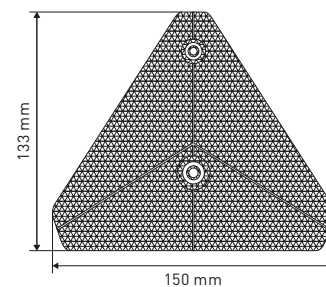

E-approved

**TOTAL SOURCE**<sup>®</sup>

### REF 152TA1650

- Colour: red
- Shape: triangular
- Mounting: screws
- Center distance: 70 mm

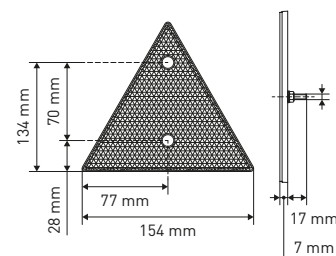

E-approved

**TOTAL SOURCE**<sup>®</sup>

- REF 150TA7832 – White
- REF 152TA1653 – Orange
- REF 152TA1645 – Red

- Colour: white
- Shape: round
- Mounting: adhesive

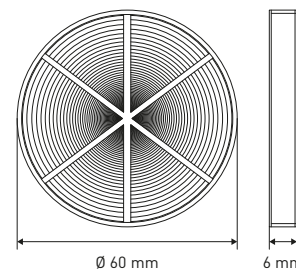

E-approved

### REF 150TA7802

- Colour: red
- Shape: round
- Mounting: adhesive

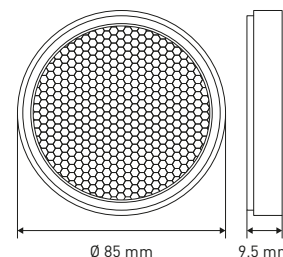

E-approved



## REFLECTORS

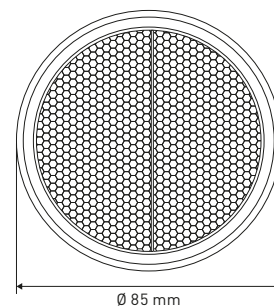

**REF 150TA8168**

- Colour: orange
- Shape: round
- Mounting: adhesive

**E-approved**

**TOTAL SOURCE®**

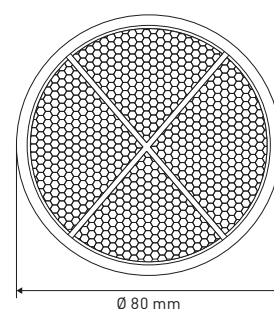

**REF 151TA5978**

- Colour: red
- Shape: round
- Mounting: adhesive

**E-approved**

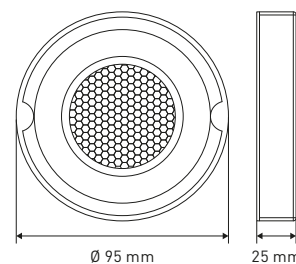

**REF 150TA8062**

- Colour: red
- Shape: round
- Mounting: screws
- Center distance: 80 mm

**E-approved**

**TOTAL SOURCE®**

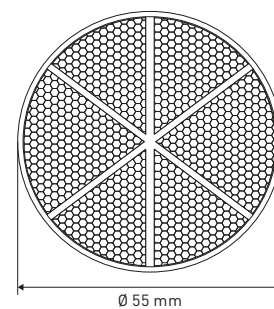

**REF 152TA1648**

- Colour: red
- Shape: round
- Mounting: one central screw M5

**E-approved**



## REFLECTORS

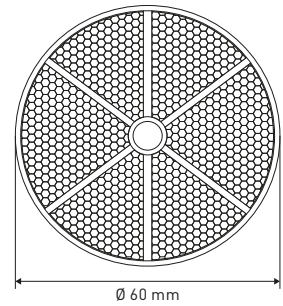

**REF 150TA7064**

- Colour: red
- Shape: round
- Mounting: screw

E-approved

**TOTAL SOURCE**<sup>®</sup>

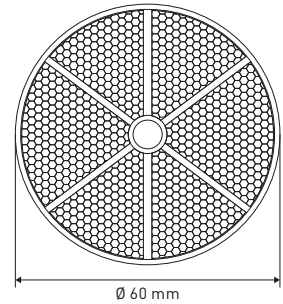

**REF 152TA1656**

- Colour: orange
- Shape: round
- Mounting: screw

E-approved

**TOTAL SOURCE**<sup>®</sup>

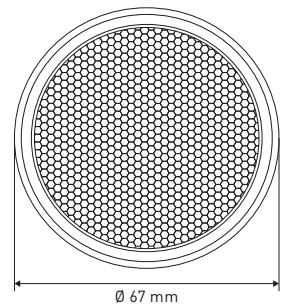

**REF 150TA8828**

- Colour: red
- Shape: round
- Mounting: screw

**TOTAL SOURCE**<sup>®</sup>

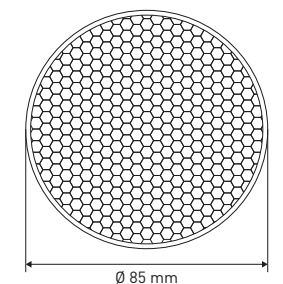

**REF 150TA7511**

- Colour: red
- Shape: round
- Mounting: screw

E-approved





## REFLECTORS

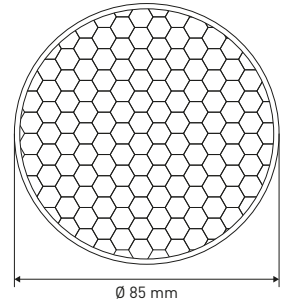

**REF 150TA7820**

- Colour: red
- Shape: round
- Mounting: screw

**TOTAL SOURCE**<sup>®</sup>

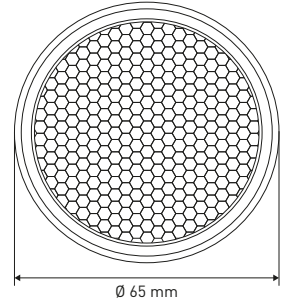

**REF 150TA7790**

- Colour: red
- Shape: round
- Mounting: screw





## REFLECTORS

### REF [164TA5483](#)

- Dimensions (L x W): 423 x 423 mm
- Zinc plated metal

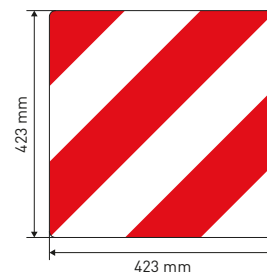

German parking panel

**TOTAL SOURCE**<sup>®</sup>

### REF [164TA5484](#)

- Panel indicating agricultural equipment
- Dimensions (L x W): 423 x 423 mm
- Zinc plated metal

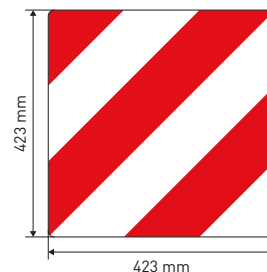

DIN 11050 – class 1 film

**TOTAL SOURCE**<sup>®</sup>

### REF [144TA5880](#)

- Kit of 2 right and left square panels, with reflecting red and white film class 1 – homologated TPESC
- Regulations for French agricultural vehicles
- Dimensions (L x W): 423 x 423 x 1 mm
- Material: aluminium

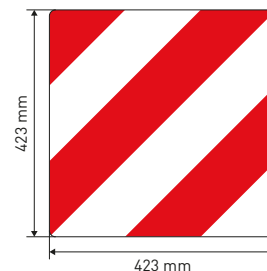

TPESC – class 1 film

**TOTAL SOURCE**<sup>®</sup>



## WARNING REFLECTORS

- REF 152TA2237** – Alu panel set 2 pcs  
**REF 164TA6489** – Vinyl kit 2 trailer decals
- Aluminium kit 2 trailer panels
  - Panels  $\geq$  3500 kg
  - ECE 70 01
  - Panel or decal: reflecting/fluorescent
  - Dimensions (L x W x H): 565 x 196 x 1 mm

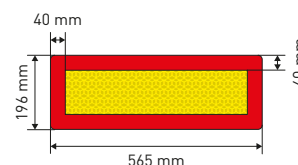

### Trailer panels

**TOTAL SOURCE**<sup>®</sup>

- REF 163TA6806**
- Single panel  $\geq$  3500 kg
  - ECE 70 01
  - Panel reflecting/reflecting
  - Dimensions (L x W x H): 1130 x 196 x 1 mm

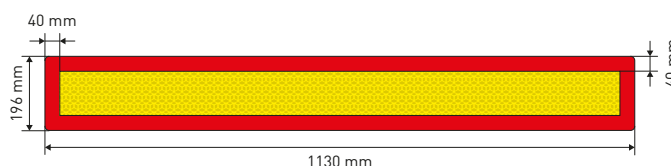

### Trailer panels

**TOTAL SOURCE**<sup>®</sup>

- REF 152TA2236** – Aluminium – kit 2 truck panels  
**REF 164TA6490** – Vinyl – kit 2 truck decals
- Panel  $\geq$  3500 kg
  - ECE 70 01
  - Panel reflecting/reflecting
  - Dimensions (L x W x H): 565 x 196 x 1 mm

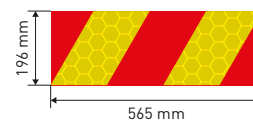

### Truck panels

**TOTAL SOURCE**<sup>®</sup>





# MARKER LIGHTS



## NICE TO KNOW – MARKER LIGHTS



Marker lights are used to inform the surroundings of the length and width of the vehicle and its potential load. These lights are attached to the side of the vehicle and to a potential load or trailer. Some models can be used on both sides of the vehicle, these are mainly orange side markers. In addition, there are also models with a rubber intermediate section in which the red and white lens can be exchanged and be mounted on both sides. The lights are mounted with screws, either with a rubber spacer or without (depending on the design of the light). Both LED marker lights and marker lights with incandescent bulbs are available.



## MARKER LIGHTS

**REF 151TA3161** – 12-24V

- Technology: incandescent
- Mounting: 2 bolts
- Center distance: 45 mm
- Function: position and turn function
- Bulbs not included

**REF 103TA4537** – Bulb: SV8,5-8 12V 5W

**REF 122TA9113** – Bulb: BA15S 12V 21W

**REF 103TA4539** – Bulb: SV8,5-8 24V 5W

**REF 103TA4603** – Bulb: BA15S 24V 21W

**REF 150TA3704** – Replacement lens

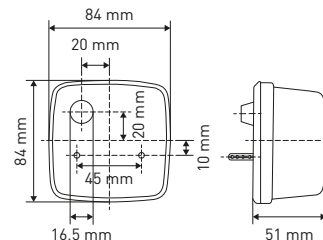

E-approved

**REF 151TA3323** – 12-24V white

- Technology: incandescent
- Mounting: 2 bolts
- Center distance: 45 mm
- Bulb not included

**REF 122TA9113** – Bulb: BA15S 12V 21W

**REF 131TA4772** – Bulb: BA15S 24V 18W

**REF 151TA3324** – Replacement lens

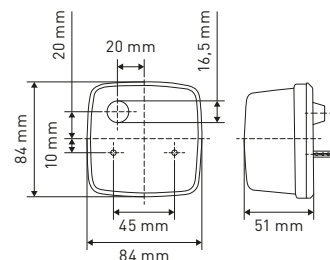
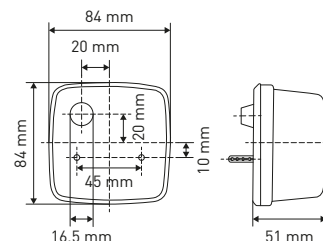

**REF 161TA5992** – 12-24V red

- Technology: incandescent
- Mounting: 2 bolts
- Center distance: 45 mm
- Bulb not included

**REF 122TA9113** – Bulb: BA15S 12V 21W

**REF 131TA4772** – Bulb: BA15S 24V 18W





## MARKER LIGHTS

**REF 151TA3331** – Bulbs not included

**REF 151TA3271** – 12V

- Technology: incandescent
- Mounting: 2 bolts
- Center distance: 45 mm
- Bulbs included

**REF 123TA7982** – Bulb: BA15S 12V 5W

**REF 100TA2215** – Bulb: BA15S 12V 21W

**REF 103TA4587** – Bulb: BA15S 24V 5W

**REF 103TA4603** – Bulb: BA15S 24V 21W

**REF 151TA3272** – Replacement lens

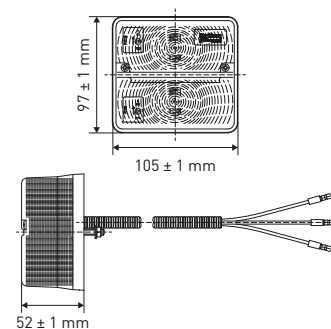

E-approved

**TOTAL SOURCE**®

**REF 151TA3311** – 12-24V

- Technology: incandescent
- Mounting: 2 bolts
- Center distance: 58 mm
- Bulbs not included

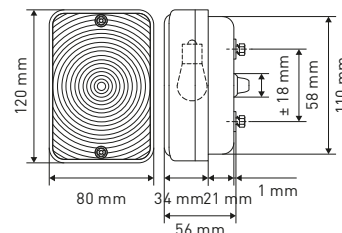

**REF 100TA2215** – Bulb: BA15S 12V 21W

**REF 123TA7982** – Bulb: BA15S 12V 5W

**REF 103TA4603** – Bulb: BA15S 24V 21W

**REF 103TA4587** – Bulb: BA15S 24V 5W

**REF 151TA3312** – Replacement lens

E-approved

**COBO**  
*grow*

**REF 151TA3313** – 12V

- Technology: incandescent
- Mounting: 2 bolts
- Wire length: 250 mm
- Bulbs included
- Used for Nissan
- Connector: type 4, F1 and type 8

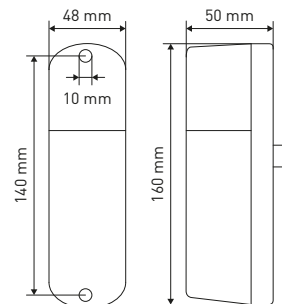

**REF 100TA2191** – Bulb: BA15S 12V 10W

**REF 103TA4602** – Bulb: BA15S 12V 25W

**REF 151TA3314** – Replacement lens

**REF 151TA2994** – Bracket

**TOTAL SOURCE**®



## MARKER LIGHTS

**REF 151TA3262** – 12-24V

- Technology: incandescent
- Mounting: 2 bolts
- Center distance: 58 mm
- Bulbs not included

**REF 115TA4601** – Bulb: BA9S 12V 5W

**REF 100TA2215** – Bulb: BA15S 12V 21W

**REF 103TA4577** – Bulb: BA9S 24V 4W

**REF 103TA4603** – Bulb: BA15S 24V 21W

**REF 150TA4943** – Replacement lens

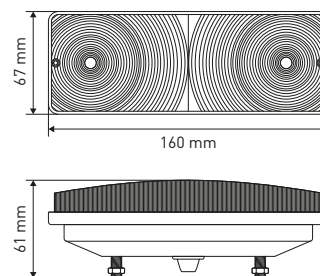

E-approved

**REF 151TA3315** – 12V

- Technology: incandescent
- Mounting: 2 bolts
- Center distance: 133 mm
- Wire length: 220 mm
- Bulbs included
- Connector: 2 x F1 and G1

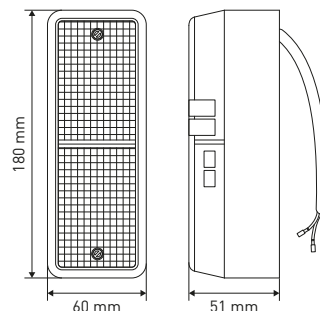

E-approved

**REF 103TA4585** – Bulb: BA15S 12V 5W

**REF 100TA2215** – Bulb: BA15S 12V 21W

**REF 150TA1016** – Replacement lens

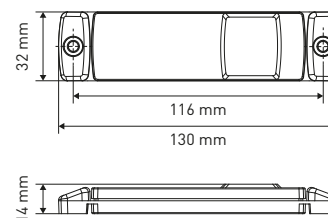

**REF 149TA2888** – 12-24V

- Technology: LED
- Mounting: 2 bolts
- Center distance: 116 mm
- Wire length: 500 mm
- Colour: orange
- Function: side reflex



## MARKER LIGHTS

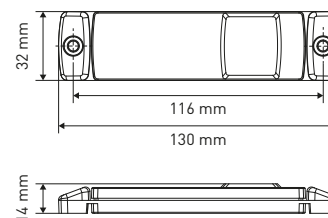

**REF 149TA2889** – 12-24V

- Technology: LED
- Mounting: 2 bolts
- Center distance: 116 mm
- Wire length: 500 mm
- Colour: white
- Function: front reflex

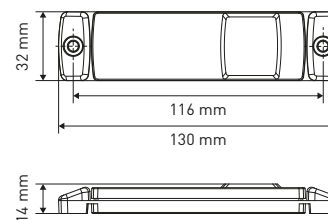

**REF 149TA2890** – 12-24V

- Technology: LED
- Mounting: 2 bolts
- Center distance: 116 mm
- Wire length: 500 mm
- Colour: orange
- Function: rear reflex

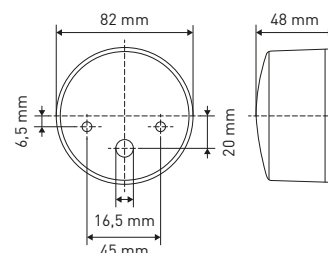

**REF 151TA3162** – 12-24V

- Technology: incandescent
- Mounting: 2 bolts
- Center distance: 45 mm
- Lens: plastic
- Bulbs not included

**REF 103TA4537** – Bulb: SV8,5-8 12V 5W

**REF 122TA9113** – Bulb: BA15S 12V 21W

**REF 103TA4539** – Bulb: SV8,5-8 24V 5W

**REF 103TA4603** – Bulb: BA15S 24V 21W

**REF 150TA4732** – Replacement lens





## MARKER LIGHTS

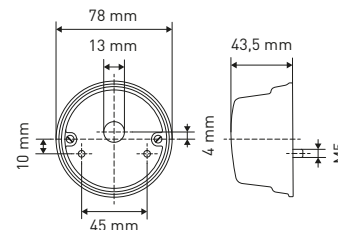

**REF 151TA3318**

- Type of technology: incandescent
- Mounting: 2 bolts
- Center distance: 45 mm
- Bulbs not included
- 12V

**REF 103TA4541** – Bulb: SV8,5-8 12V 18W

**REF 103TA4533** – Bulb: SV7-8 12V 3W

**REF 151TA3319** – Replacement lens

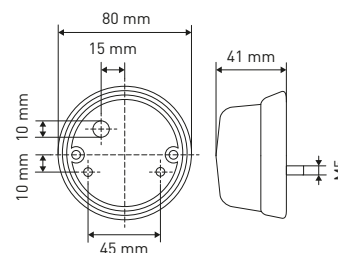

**REF 151TA3265**

- Technology: incandescent
- Mounting: 2 bolts
- Center distance: 45 mm
- Bulbs not included
- 12-24V
- Green

Amber version, see page 43 (REF 151TA3944)

Red version, see page 126 (REF 151TA5982)

**REF 106TA4833** – Bulb: SV8,5-8 24V 18W

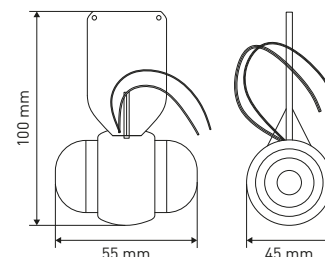

**REF 163TA8597** – 12-24V

- Technology: LED (red/white)
- Mounting: 2 bolts
- Center distance: 32 mm
- Wire length: 350 mm
- IP67
- Certified CE R7





## MARKER LIGHTS

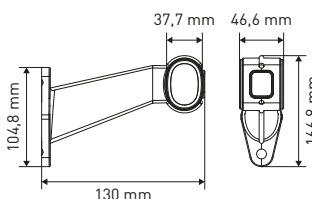

**REF 149TA2893** – 12-24V

- Technology: LED
- Mounting: 2 bolts
- Center distance: 78 mm
- Wire length: 300 mm

**TOTAL SOURCE**<sup>®</sup>



1 Pull

2 Turn

3 Push

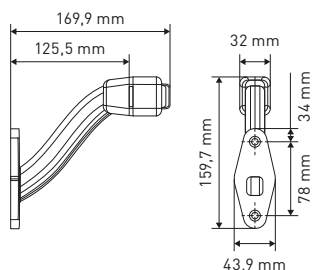

**REF 149TA2894** – 12-24V

- Technology: LED
- Mounting: 2 bolts
- Center distance: 78 mm
- Wire length: 300 mm

**TOTAL SOURCE**<sup>®</sup>

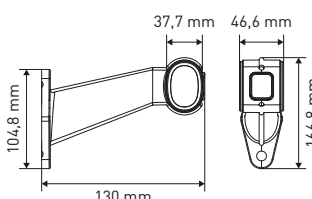

**REF 149TA2891** – 12-24V LH

**REF 149TA2892** – 12-24V RH

- Technology: LED
- Mounting: 2 bolts
- Wire length: 500 mm

**TOTAL SOURCE**<sup>®</sup>





## MARKER LIGHTS

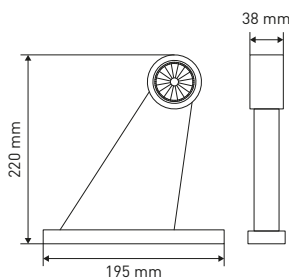

**REF 163TA8598** – 10–30V

- Technology: LED
- Mounting: 2 bolts
- Center distance: 78 mm
- Wire length: 350 mm
- IP67

**TOTAL SOURCE**®

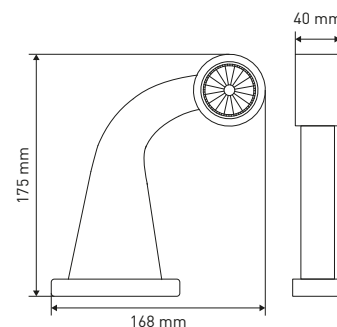

**REF 163TA8599** – 10–30V

- Technology: LED
- Mounting: 2 bolts
- Center distance: 78 mm
- Wire length: 300 mm
- IP67
- Lenses are interchangeable

**TOTAL SOURCE**®

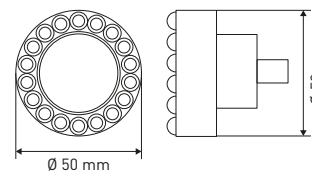

**REF 151TA6121** – Green

**REF 151TA6128** – Red

**REF 148TA4052** – Yellow

- Technology: LED
- Mounting: central bolt
- 12–30V
- Connector pins: 4
- Bulb not replaceable
- Used on Kalmar, container spreader

**TOTAL SOURCE**®



## LED MARKER 4-PIN

- REF 151TA6112** – Green
- REF 151TA6113** – Red
- REF 151TA6115** – Yellow
- REF 151TA6117** – Blue
- REF 151TA6119** – White

- Technology: LED
- Mounting: central bolt
- 12–30V
- Connector pins: 4
- Used on Bromma

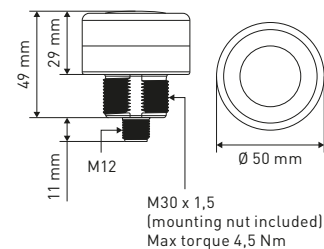

**TOTAL SOURCE®**

## LED MARKER 3-PIN

- REF 151TA6111** – Green
- REF 151TA6114** – Red
- REF 151TA6116** – Yellow
- REF 151TA6118** – Blue
- REF 151TA6120** – White

- Technology: LED
- Mounting: central bolt
- 90–240V
- Connector pins: 3
- Used on Bromma

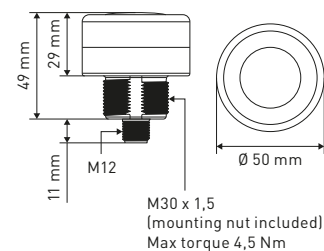

**TOTAL SOURCE®**



# LICENSE PLATE LIGHTS



## NICE TO KNOW – LICENSE PLATE LIGHTS



It is important to be able to visibly identify a vehicle.

Number plate lighting can be installed as a loose module, but is sometimes also installed in the rear light. This lighting must always be lit simultaneously with the main beam headlights, dimmed headlights, parking lights or fog lights of the rear lighting.

It is available in LED technology and as a model equipped with an incandescent bulb.

The number plate lighting can't illuminate the side of the vehicle, nor an area behind the vehicle.



## LICENSE PLATE LIGHTS

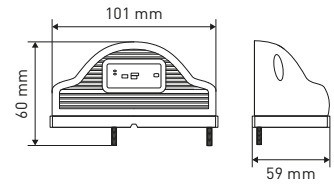

**REF 163TA8596** – 12-24V

- Technology: LED
- Mounting: 2 bolts
- Center distance: 71 mm
- Wire length: 500 mm
- IP68
- Certified CE R7

**E-approved**

**TOTAL SOURCE®**

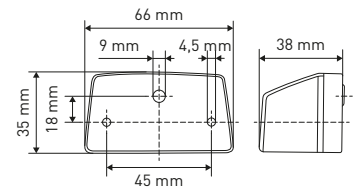

**REF 151TA6039** – 12V

- Technology: incandescent
- Mounting: 2 bolts
- Center distance: 43 mm
- Wire length: 135 mm
- Bulb included
- Connector: Deutsch

**REF 103TA4537** – Bulb: SV8,5-8 12V 5W

**E-approved**

**TOTAL SOURCE®**

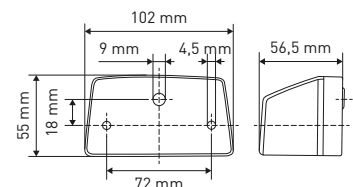

**REF 151TA6097**

- Technology: incandescent
- Mounting: 2 holes
- Center distance: 72 mm
- 12-24V
- Bulb not included

**REF 100TA2190** – Bulb: BA15S 12V 5W

**REF 103TA4587** – Bulb: BA15S 24V 5W

**REF 150TA6407** – Replacement lens

**E-approved**





## LICENSE PLATE LIGHTS

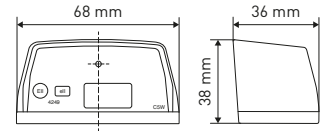

- REF 148TA2024** – 12V
- Technology: incandescent
  - Mounting: 2 bolts
  - Center distance: 45 mm
  - Bulb included

**REF 103TA4537** – Bulb: SV8,5-8 12V 5W

**E-approved**

**TOTAL SOURCE®**

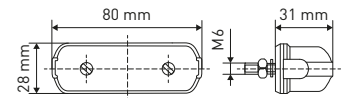

- REF 151TA6070**
- Technology: incandescent
  - Mounting: 2 bolts
  - Center distance: 45 mm
  - 12-24V
  - Bulb not included

**REF 100TA2118** – Bulb: SV8,5-8 12V 5W

**REF 106TA4829** – Bulb: SV8,5-8 24V 10W

**E-approved**

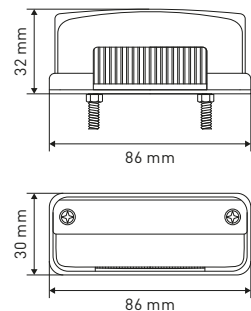

- REF 151TA6098**
- Technology: incandescent
  - Mounting: 2 bolts
  - Center distance: 44 mm
  - 12-24V
  - Bulb not included

**REF 100TA2118** – Bulb: SV8,5-8 12V 5W

**REF 106TA4829** – Bulb: SV8,5-8 24V 10W

**E-approved**





# SAFETY LIGHTS



## NICE TO KNOW – SAFETY LIGHTS



Safety lights warn bystanders of the presence of an approaching machine by means of a visual warning signal. The blue spot and red spot warning lights project a blue/red spot or arrow onto the floor, a few metres in front of or behind the machine (depending on where it was installed). In addition, there is also a 'red zone' light that projects a solid line onto the floor to mark a forbidden zone alongside a vehicle. By combining these lights, a complete area can be surrounded by using light.





## BLUE SPOT LIGHTS

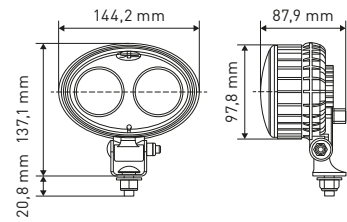
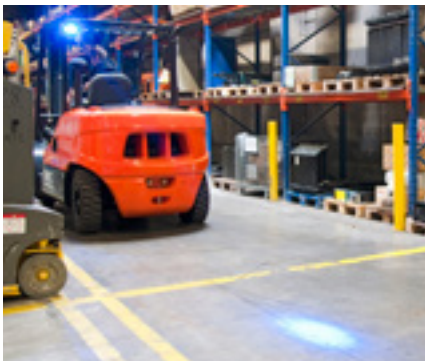

**REF 147TA3431** – 12-110V

- Technology: LED 2 pieces
- Mounting: pedestal M10
- Colour: blue
- Nominal power: 10W
- IP67
- Connector: J2 built-in

**TOTAL SOURCE**<sup>®</sup>

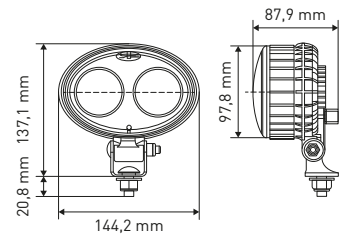
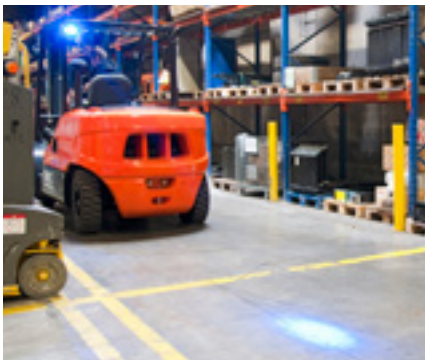

**REF 140TA2243** – 12-110V

- Technology: LED 2 pieces
- Mounting: pedestal M10
- Colour: blue
- Nominal power: 10W
- IP67
- Connector: J2 built-in

**TOTAL SOURCE**<sup>®</sup>

BRAND: SPEAKER

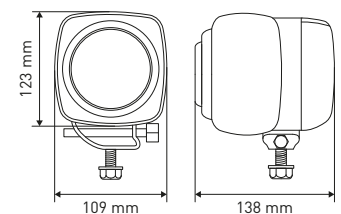

**REF 141TA6749** – 12-100V

- Technology: LED 1 piece
- Mounting: pedestal M10
- Colour: blue
- Nominal power: 6W
- IP68
- Connector: J2 built-in

**ABL**



## BLUE SPOT LIGHTS

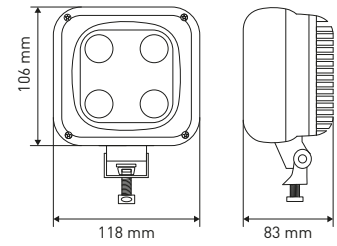
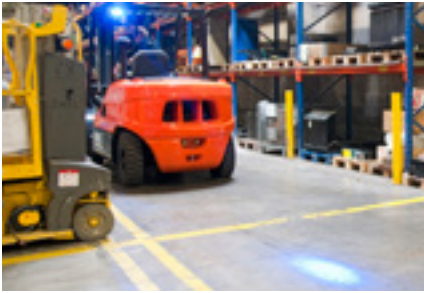

- REF 152TA1662** – 12-48V
- Technology: LED 4 pieces
  - Mounting: pedestal M10
  - Colour: blue
  - Wire length: 1020 mm
  - Nominal power: 15W
  - IP69
  - Connector: J2 built-in



## BLUE ARROW SPOT LIGHT

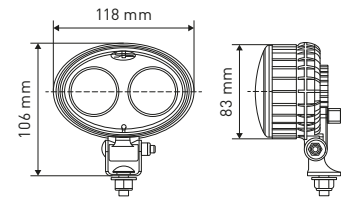

- REF 148TA8124** – 12-48V
- Technology: LED 2 pieces
  - Mounting: pedestal M10
  - Colour: blue arrow spot
  - Wire length: 1020 mm
  - Nominal power: 15W
  - IP69
  - Connector: J2 built-in





## RED SPOT LIGHTS



**REF 148TA9614** – 12-110V

- Technology: LED 2 pieces
- Mounting: pedestal M10
- Colour: red
- Nominal power: 10W
- IP67
- Connector: J2 built-in

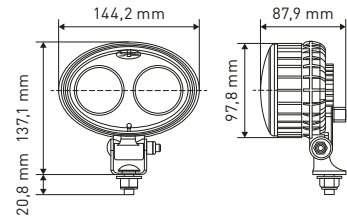

**TOTAL SOURCE**<sup>®</sup>

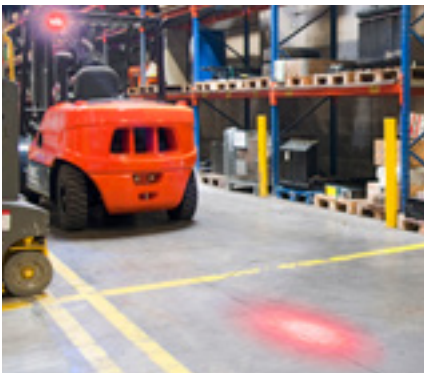

**REF 141TA6748** – 12-80V

- Technology: LED 2 pieces
- Mounting: pedestal M10
- Colour: red
- Nominal power: 10W
- IP67
- Connector: J2 built-in

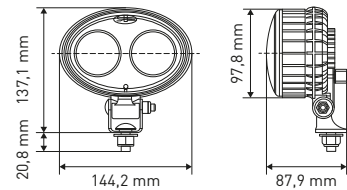

**TOTAL SOURCE**<sup>®</sup>

BRAND: SPEAKER



## RED SAFETY ZONE WARNING LIGHT

**NEW!**

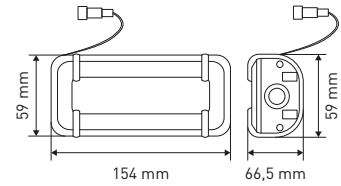

- REF 163TA8854** – 9–60V
- Technology: LED 6 pieces
  - Mounting: brackets
  - Colour: red line
  - Nominal power: 30W
  - IP67

One light needed on each side

**TOTAL SOURCE**<sup>®</sup>

## BLUE SAFETY ZONE WARNING LIGHT

**NEW!**

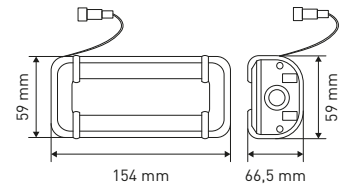

- REF 164TA9700** – 9–60V
- Technology: LED 6 pieces
  - Mounting: brackets
  - Colour: blue line
  - Nominal power: 30W
  - IP67

One light needed on each side

**TOTAL SOURCE**<sup>®</sup>



# WORK LIGHTS



## NICE TO KNOW – WORK LIGHTS



Work lights are used to illuminate the work area. These can only be used off-road and can't be used on public roads. Work lights are available with LED technology as well as with halogen, xenon, and incandescent bulb technology, in square, rectangular or round shape.

### LED work lights

LED work lights are split up into 2 types:

- Flood beam: illuminates a wide area over a short distance
- Spot beam: illuminates a long, narrow area over a longer distance. The intensity of the light is higher in comparison with a flood beam light.

The light output of LED work lights is indicated in a value of lumen. The flood beam worklight is most common and most used. If a worklight has a spot beam or is available in both versions, this will be mentioned in the title or specifications. In all other situations the light shown will have a flood beam.

### Advantages of LED

- Long lifespan: up to 100x the lifespan of a halogen bulb
- Maintenance-free
- Low power consumption
- Waterproof
- Vibration-resistant
- Robust

### Halogen/incandescent bulb work lights

For work lights that use halogen or incandescent bulb technology, the light output isn't expressed in lumen but the power of the used bulb is stated. This means there are different voltages possible as well, all possible replacement bulbs are listed as spare part. In order to be able to compare the light output in lumen to the wattage of an incandescent bulb, you can use below table:

Lumen	Incandescent bulb (wattage)	Fluorescent lamp (wattage)	LED (wattage)
450	40	± 10	± 8
850	60	± 15	± 10
1500	80-85	± 20	± 15
1800	100	± 25	± 18
2800	150	± 45	± 27

### Installation

There are models that require either a standing (pedestal) or a hanging (pendant) installation. Some work lights even require a lateral installation.

### Flood beam

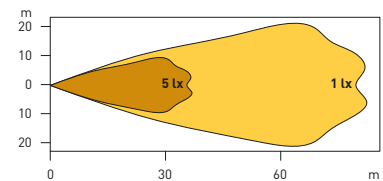

### Spot beam

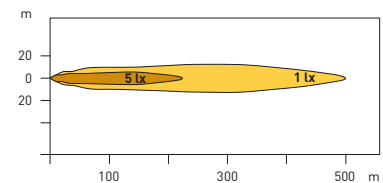



## FLOOD/SPOT WORK LIGHTS

**REF 152TA1657** – 12-48V

**REF 152TA1658** – 12-80V

- Technology: LED 4 pieces
- Mounting: pedestal M12
- Wire length: 300 mm
- Theoretical output: 850 lumen
- Operating light output: 450 lumen
- Nominal power: 8,5W
- IP66

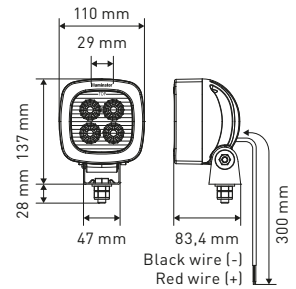

**Illuminator**®

## SPOT WORK LIGHTS

**REF 152TA1659** – 9-32V

- Technology: LED
- Mounting: pedestal M8
- Wire length: 400 mm
- Theoretical output: 900 lumen
- Operating light output: 680 lumen
- Nominal power: 10W
- IP67

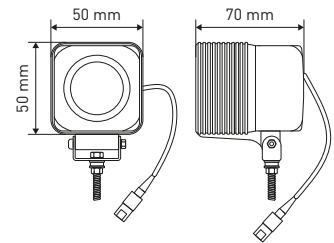

**TOTAL SOURCE**®

**REF 152TA1661** – 10-48V

- Technology: LED 4 pieces
- Mounting: pedestal M10
- Wire length: 510 mm
- Theoretical light output: 2100 lumen
- Operating light output: 1600 lumen
- Nominal power: 20W
- IP67

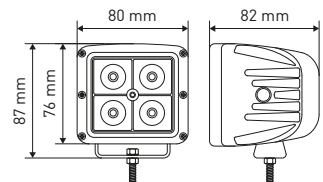

**TOTAL SOURCE**®



## FLOOD/SPOT WORK LIGHTS

**REF 152TA1694** – Flood beam

**REF 152TA1695** – Spot beam

- Technology: LED 5 pieces
- Mounting: pedestal M8
- Extra: 4-point bracket included
- Wire length: 395 mm
- 9–32V
- Theoretical output: 900 lumen
- Operating light output: 675 lumen
- Nominal power: 15W
- IP68

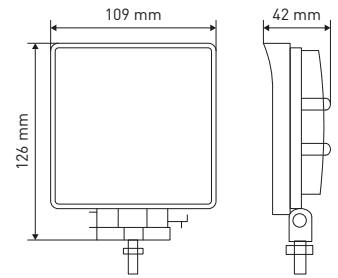

**TOTAL SOURCE**®

**REF 152TA1701** – Flood beam

- Technology: LED 5 pieces
- Mounting: pedestal M10
- Extra: 4-point bracket included
- Wire length: 460 mm
- 9–32V
- Theoretical output: 900 lumen
- Operating light output: 675 lumen
- Nominal power: 15W
- IP67

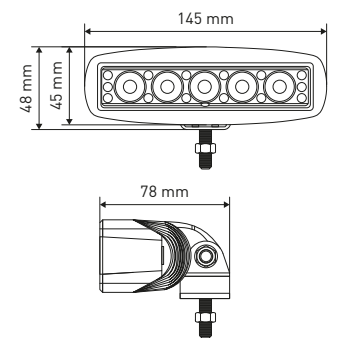

**TOTAL SOURCE**®

**REF 152TA1700** – Flood beam

- Technology: LED 12 pieces
- Mounting: pedestal M8
- Wire length: 185 mm
- 12–48V
- Theoretical output: 900 lumen
- Operating light output: 750 lumen
- Nominal power: 24W
- IP67

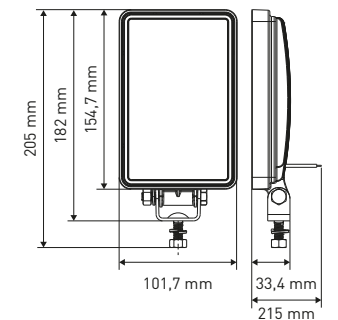

**TOTAL SOURCE**®

**REF 152TA1666** – Flood beam

- Technology: LED
- Mounting: pedestal M8
- Wire length: 5000 mm
- 12–48V
- Theoretical output: 900 lumen
- Operating light output: 600 lumen
- Nominal power: 38W
- IP69

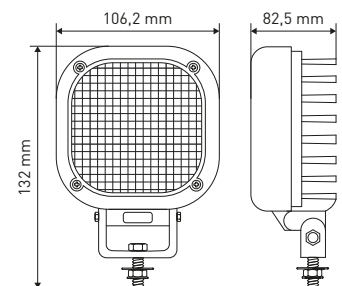

**TYRI**





## FLOOD/SPOT WORK LIGHTS

### REF 152TA1660 – 10–30V

- Technology: LED 12 pieces
- Mounting: pedestal M10
- Theoretical output: 1000 lumen
- Operating light output: 850 lumen
- Nominal power: 11W
- IP68
- Connector: J2

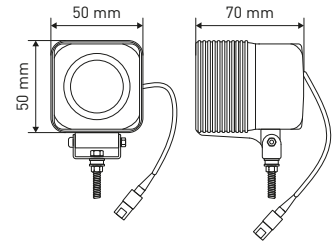

### REF 152TA1663 – 12–80V

- Technology: LED 4 pieces
- Mounting: pedestal M10
- Theoretical light output: 1100 lumen
- Operating light output: 750 lumen
- Nominal power: 17W
- IP68
- Connector: E2 built-in

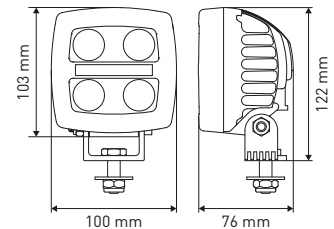

### REF 152TA1664 – 12–100V

- Technology: LED 5 pieces
- Mounting: pedestal M10
- Theoretical light output: 1200 lumen
- Operating light output: 1000 lumen
- Nominal power: 20W
- IP68
- Connector: J2 built-in

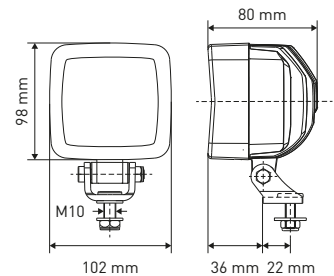

### REF 152TA1698 – Flood beam

### REF 152TA1699 – Spot beam

- Technology: LED 9 pieces
- Mounting: pedestal M10
- Extra: 4-point bracket included
- Wire length: 475 mm
- 10–30V
- Theoretical output: 1650 lumen
- Operating light output: 1226 lumen
- Nominal power: 27W
- IP68

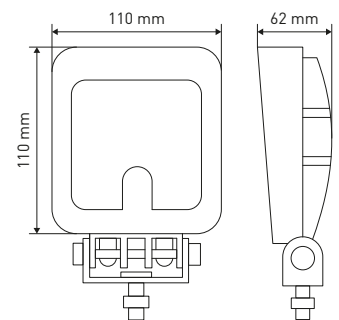



## FLOOD/SPOT WORK LIGHTS

**REF 152TA1668** – Flood beam

**REF 152TA1669** – Spot beam

- Technology: LED 4 pieces
- Mounting: pedestal M10
- Wire length: 460 mm
- 9–40V
- Theoretical output: 4000 lumen
- Operating light output: 2800 lumen
- Nominal power: 40W
- IP68

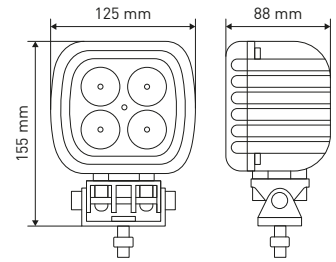

**TOTAL SOURCE**<sup>®</sup>

**REF 152TA1670** – Flood beam

**REF 152TA1671** – Spot beam

- Technology: LED 16 pieces
- Mounting: pedestal M10
- Wire length: 465 mm
- 12–30V
- Theoretical output: 4800 lumen
- Operating light output: 3450 lumen
- Nominal power: 48W
- IP68

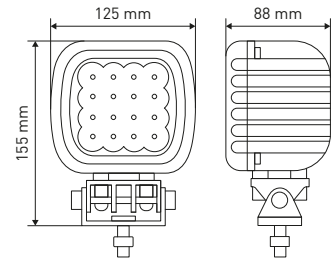

**TOTAL SOURCE**<sup>®</sup>

**REF 152TA1690** – Flood beam

**REF 152TA1691** – Spot beam

- Technology: LED 10 pieces
- Mounting: pendant
- 12–24V
- Theoretical output: 6700 lumen
- Operating light output: 4200 lumen
- Nominal power: 50W
- IP68
- Connector: E2 built-in
- Heavy-duty damping

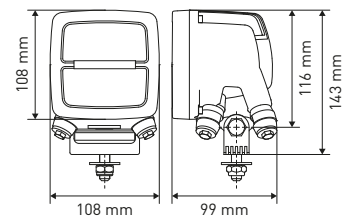

**TOTAL SOURCE**<sup>®</sup>

BRAND: NORDIC LIGHTS

**REF 143TA7877** – Flood beam

**REF 143TA7878** – Spot beam

- Technology: LED 8 pieces
- Mounting: pedestal M10
- Extra: 4-point bracket included
- 24V
- Theoretical output: 9600 lumen
- Operating light output: 6000 lumen
- Nominal power: 85W
- IP68
- Connector: E2 built-in

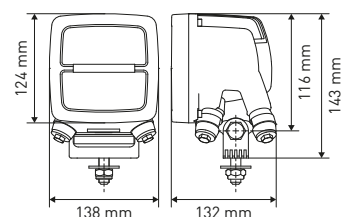

**TOTAL SOURCE**<sup>®</sup>

BRAND: NORDIC LIGHTS



## FLOOD/SPOT WORK LIGHTS

**REF 152TA1704** – Vertical oval

**REF 152TA1705** – Horizontal oval

- Technology: LED 6 pieces
- Mounting: pedestal M8
- Wire length: 320 mm
- 12–48V
- Theoretical output: 900 lumen
- Operating light output: 700 lumen
- Nominal power: 12W
- IP67

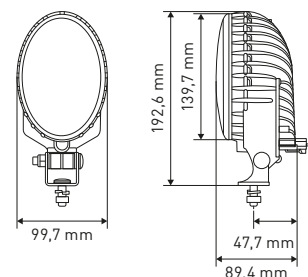

**TOTAL SOURCE**<sup>®</sup>

BRAND : SPEAKER

**REF 152TA1706** – 12–48V round

**REF 152TA1707** – 12–80V round

- Technology: LED 4 pieces
- Mounting: pedestal M12
- Wire length: 290 mm
- Theoretical output: 800 lumen
- Operating light output: 450 lumen
- Nominal power: 12W
- IP66

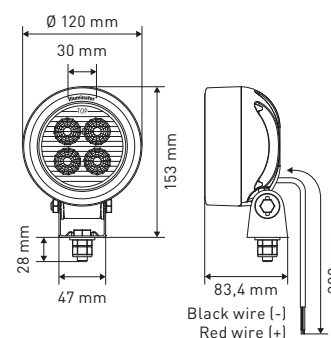

**Illuminator**<sup>®</sup>

**REF 152TA1708** – 9–60V

- Technology: LED
- Mounting: pedestal M10
- Extra: handlebar mount included
- Wire length: 450 mm
- Theoretical output: 1000 lumen
- Operating light output: 750 lumen
- Nominal power: 10W
- IP68

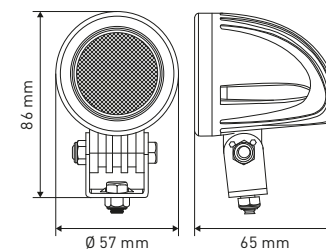

**TOTAL SOURCE**<sup>®</sup>

**REF 152TA1709** – 12–100V

- Technology: LED 4 pieces
- Mounting: pedestal M8
- Theoretical output: 1000 lumen
- Operating light output: 850 lumen
- Nominal power: 12W
- IP68
- Connector: E2 built-in

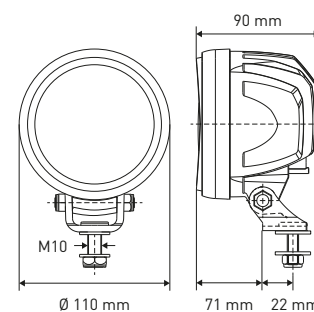

**ABL**



## FLOOD/SPOT WORK LIGHTS

**REF 152TA1712** – Flood beam 10–30V

**REF 152TA1713** – Spot beam 10–30V

**REF 152TA1715** – 12–48V

- Technology: LED 6 pieces
- Mounting: pedestal M10
- Extra: 4-point bracket included
- Wire length: 500 mm
- Theoretical output: 1080 lumen
- Operating light output: 810 lumen
- Nominal power: 18W
- IP68

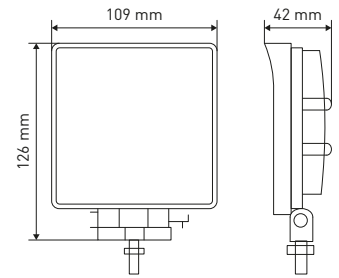

**TOTAL SOURCE®**

**REF 152TA1716** – Flood beam

**REF 152TA1717** – Spot beam

- Technology: LED 9 pieces
- Mounting: pedestal M10
- Extra: 4-point bracket included
- Wire length: 490 mm
- 9–32V
- Theoretical output: 1650 lumen
- Operating light output: 1226 lumen
- Nominal power: 27W
- IP68

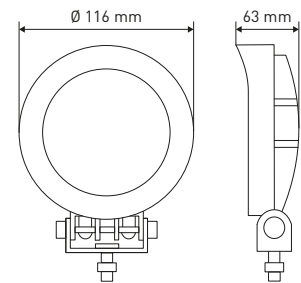

**TOTAL SOURCE®**

**REF 152TA1710** – Flood beam

**REF 152TA1711** – Spot beam

- Technology: LED 4 pieces
- Mounting: pedestal M8
- Wire length: 460 mm
- 9–40V
- Theoretical output: 4000 lumen
- Operating light output: 2800 lumen
- Nominal power: 40W
- IP68

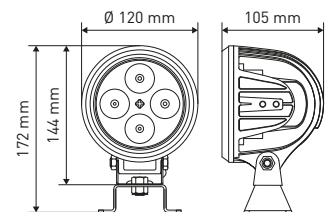

**TOTAL SOURCE®**

## XENON HID WORK LIGHT

**REF 152TA1720** – 12–24V

- Technology: xenon
- Mounting: pedestal M8
- Wire length: 1075 mm
- Nominal power: 35W
- Tube included (REF 164TA9408)

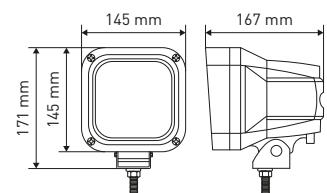

**TOTAL SOURCE®**



## WORK LIGHTS

### REF 147TA3112

- Technology: halogen
- Mounting: pedestal M10
- 12-24-36-48V
- IP67
- Bulb not included
- Connector: J2 built-in

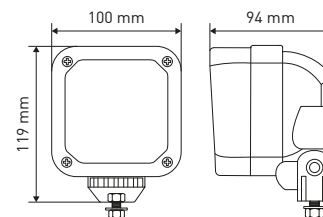

REF 161TA6105 – Bulb: H3 12V 55W

REF 161TA6106 – Bulb: H3 24V 70W

REF 142TA1218 – Bulb: H3 36V 45W

REF 144TA5499 – Bulb: H3 48V 45W

**TOTAL SOURCE**<sup>®</sup>

BRAND: NORDIC LIGHTS

REF 152TA1895 – Without bulb

REF 152TA1896 – 12V

REF 152TA1897 – 24V

- Technology: halogen
- Mounting: pedestal M10
- IP66
- Bulb included

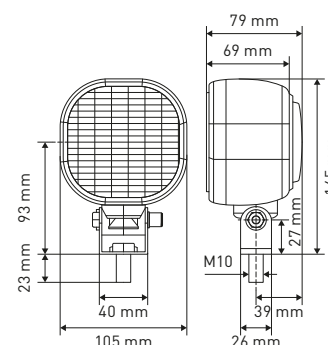

**COBO**<sup>®</sup>  
group

REF 123TA8007 – Bulb: H3 12V 55W

REF 123TA8008 – Bulb: H3 24V 70W

### REF 152TA1726

- Technology: halogen
- Mounting: pedestal M10
- 12-24-36V
- IP54
- Bulb not included

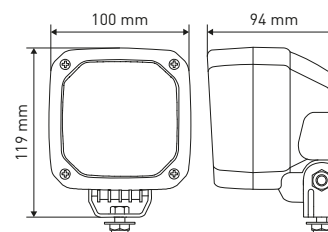

REF 161TA6105 – Bulb: H3 12V 55W

REF 161TA6106 – Bulb: H3 24V 70W

REF 142TA1218 – Bulb: H3 36V 45W

REF 152TA1727 – Small bracket

**ABL**

REF 152TA1876 – 24V

- Technology: halogen
- Mounting: pedestal M10
- Nominal power: 70W
- IP66-69K
- Bulb included
- Connector: E2 built-in

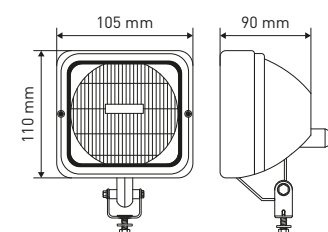

REF 161TA6106 – Bulb: H3 24V 70W

**ABL**



## WORK LIGHTS

**REF 152TA1672** – 12V

- Technology: halogen
- Mounting: side M8
- Nominal power: 55W
- IP69K
- Bulb included
- Connector: E2 built-in

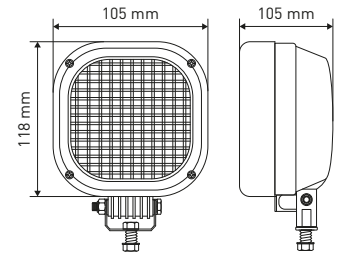

**REF 161TA6105** – Bulb: H3 12V 55W

**REF 152TA1877** – 12V

- Technology: halogen
- Mounting: side M8
- Nominal power: 55W
- IP69
- Bulb included
- Connector: E2 built-in

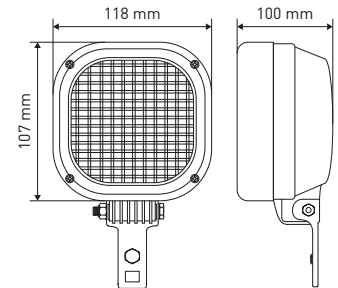

**REF 161TA6105** – Bulb: H3 12V 55W

**REF 152TA1879**

- Technology: halogen
- Mounting: 4 point bracket
- 12–24V
- IP66
- Bulb not included
- Connector: J2 built-in

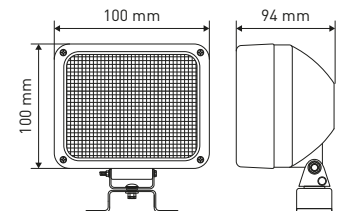

**REF 161TA6004** – Bulb: H3 12V 55W

**REF 123TA8008** – Bulb: H3 24V 70W

**REF 152TA2449** – 12V

- Technology: halogen (spot)
- Mounting: pedestal M10
- Wire length: 350 mm
- Nominal power: 55W
- Bulb included

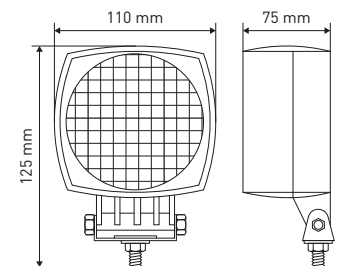

**REF 161TA6105** – Bulb: H3 12V 55W



## WORK LIGHTS

**REF 152TA1880** – 12V without bulb

**REF 152TA1884** – 24V

- Technology: halogen
- Mounting: pedestal M10
- IP5K9K
- Bulb not included
- Connector: E2 built-in

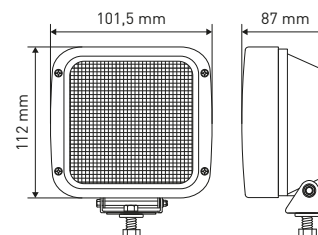

**REF 123TA8007** – Bulb: H3 12V 55W

**REF 123TA8008** – Bulb: H3 24V 70W

**REF 152TA1882** – Without bulb

**REF 152TA1883** – 12V

**REF 152TA1881** – 24V

- Technology: halogen
- Mounting: pedestal M10
- IP6K9K
- Bulb included
- Connector: J2

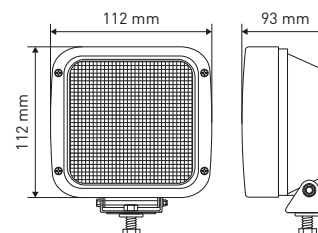

**TOTAL SOURCE®**

**REF 123TA8007** – Bulb: H3 12V 55W

**REF 123TA8008** – Bulb: H3 24V 70W

**REF 152TA1885** – 12V

- Technology: halogen
- Mounting: pedestal M10
- Wire length: 250 mm
- Nominal power: 55W
- Bulb included

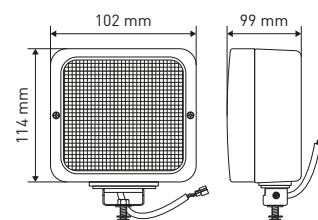

**TOTAL SOURCE®**

**REF 123TA8007** – Bulb: H3 12V 55W

**REF 152TA1886** – Without bulb

**REF 152TA1887** – 12V

**REF 148TA9047** – 24V

**REF 148TA9048** – 36V

**REF 148TA9049** – 48V

- Technology: halogen
- Mounting: pedestal M10
- Extra: 4 point bracket
- Wire length: 200 mm
- Bulb included

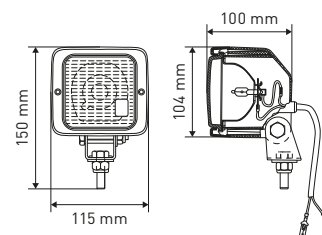

**TOTAL SOURCE®**

**REF 161TA6105** – Bulb: H3 12V 55W

**REF 161TA6106** – Bulb: H3 24V 70W

**REF 144TA5547** – Bulb: H3 36V 45W

**REF 144TA5499** – Bulb: H3 48V 45W



## WORK LIGHTS

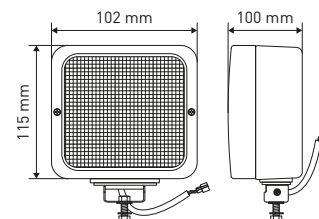

- REF 152TA1888** – 12V
- Technology: halogen
  - Mounting: pedestal M10
  - Wire length: 150 mm
  - Bulb included

**REF 161TA6105** – Bulb: H3 12V 55W

**TOTAL SOURCE**®

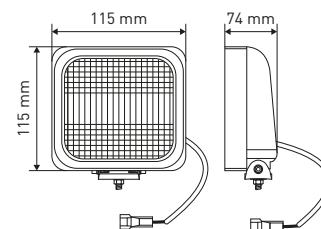

- REF 152TA1894** – 12V
- Technology: halogen
  - Mounting: pedestal M8
  - Wire length: 300 mm
  - Nominal power: 55W
  - Bulb included

**REF 123TA8007** – Bulb: H3 12V 55W

**TOTAL SOURCE**®

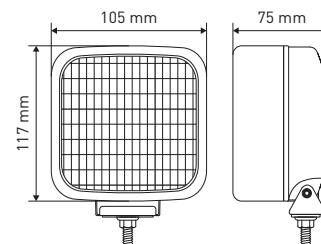

- REF 152TA1889** – 12V
- Technology: halogen
  - Mounting: pedestal M8
  - Wire length: 300 mm
  - Nominal power: 55W
  - Bulb included

**REF 161TA6105** – Bulb: H3 12V 55W

**REF 150TA1246** – Replacement lens

**TOTAL SOURCE**®

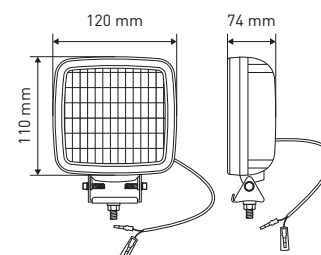

- REF 152TA1892** – 12V
- Technology: halogen
  - Mounting: pedestal M8
  - Wire length: 300 mm
  - Nominal power: 55W
  - IP64
  - Bulb included

**REF 161TA6105** – Bulb: H3 12V 55W

**TOTAL SOURCE**®





## WORK LIGHTS

**REF 152TA1898** – 12V

- Technology: halogen
- Mounting: pedestal M12
- Wire length: 450 mm
- Nominal power: 55W
- Bulb included

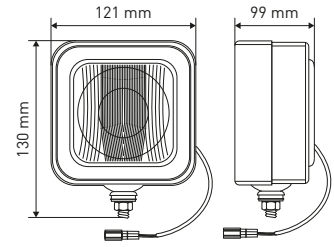

**REF 123TA8007** – Bulb: H3 12V 55W

**TOTAL SOURCE®**

**REF 152TA1900** – 12V

- Technology: incandescent
- Mounting: pedestal M8
- Wire length: 200 mm
- Nominal power: 35W
- Bulb included

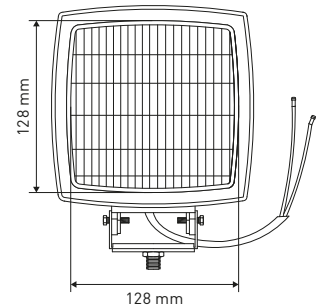

**REF 144TA5443** – Bulb: BA15S 12V 35W

**REF 151TA3214** – Replacement lens

**TOTAL SOURCE®**

**REF 152TA1901** – 24V

- Technology: incandescent
- Mounting: pedestal M8
- Wire length: 200 mm
- Nominal power: 36W
- IP65
- Bulb included

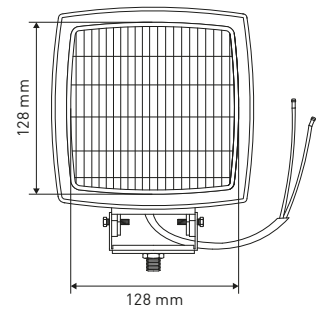

**REF 141TA9856** – Bulb: BA15S 24V 36W

**REF 151TA3214** – Replacement lens

**TOTAL SOURCE®**

**REF 152TA2398** – 24V

- Technology: incandescent
- Mounting: pedestal M8
- Wire length: 250 mm
- Nominal power: 36W
- Bulb included

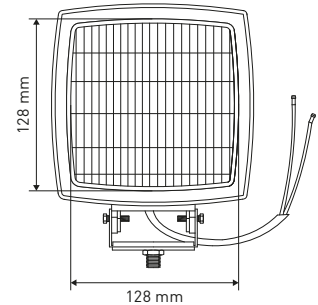

**REF 141TA9856** – Bulb: BA15S 24V 36W

**REF 151TA3214** – Replacement lens

**TOTAL SOURCE®**



## WORK LIGHTS

REF [152TA2399](#) – Without bulb

REF [147TA6951](#) – 12V

REF [148TA9280](#) – 24V

REF [148TA9153](#) – 48V

REF [148TA9154](#) – 80V

- Technology: halogen
- Mounting: pedestal M8
- IP67
- Bulb included

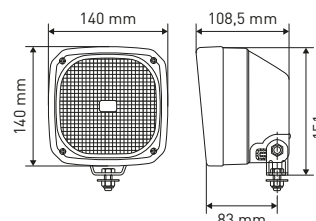

**TOTAL SOURCE®**

BRAND: NORDIC LIGHTS

REF [123TA8007](#) – Bulb: H3 12V 55W

REF [123TA8008](#) – Bulb: H3 24V 70W

REF [123TA8011](#) – Bulb: H3 48V 60W

REF [103TA4675](#) – Bulb: H3 80V 55W

REF [152TA1899](#) – 12V

REF [149TA2096](#) – 24V

- Technology: halogen

- Mounting: pedestal M8

- Wire length: 240 mm

- IP54

- Bulb not included

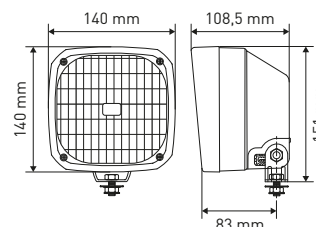

**ABL**

REF [123TA8007](#) – Bulb: H3 12V 55W

REF [123TA8008](#) – Bulb: H3 24V 70W

REF [152TA2422](#) – 12V

REF [152TA2423](#) – 24V

REF [152TA2424](#) – 48V

REF [152TA2425](#) – 80V

- Technology: halogen
- Mounting: pedestal M8
- Wire length: 300 mm
- Bulb included

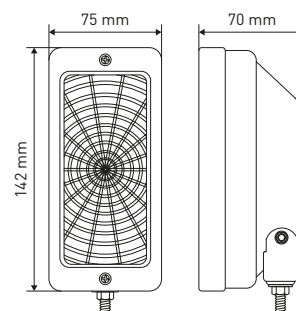

**TOTAL SOURCE®**

REF [161TA6105](#) – Bulb: H3 12V 55W

REF [161TA6106](#) – Bulb: H3 24V 70W

REF [144TA5499](#) – Bulb: H3 48V 45W

REF [103TA4675](#) – Bulb: H3 80V 55W

REF [152TA2426](#) – 12V

REF [152TA2427](#) – 24V

REF [152TA2428](#) – 48V

REF [152TA2429](#) – 80V

- Technology: halogen
- Mounting: pedestal M8
- Wire length: 300 mm
- Bulb included

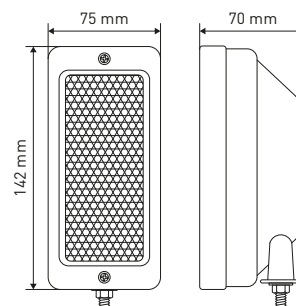

**TOTAL SOURCE®**

REF [161TA6105](#) – Bulb: H3 12V 55W

REF [161TA6106](#) – Bulb: H3 24V 70W

REF [144TA5499](#) – Bulb: H3 48V 45W

REF [103TA4675](#) – Bulb: H3 80V 55W



## WORK LIGHTS

### REF [152TA2434](#)

- Technology: halogen
- Mounting: pedestal M8
- 12–24V
- IP65
- Bulb not included

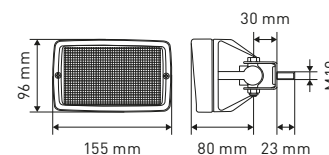

REF [123TA8007](#) – Bulb: H3 12V 55W

REF [123TA8008](#) – Bulb: H3 24V 70W

**TOTAL SOURCE®**

### REF [152TA2443](#) – 48V

- Technology: incandescent
- Mounting: pedestal M8
- Wire length: 250 mm
- Nominal power: 25W
- IP65
- Bulb included

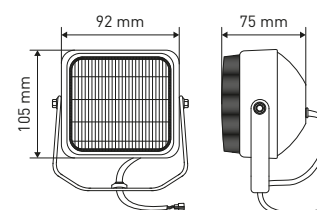

REF [144TA5559](#) – Bulb: BAY15D 48V 25W

REF [152TA2444](#) – Replacement lens

**TOTAL SOURCE®**

REF [152TA2439](#) – 48V without connector

REF [152TA2440](#) – 48V

- Technology: incandescent
- Mounting: pedestal M10
- Wire length: 250 mm
- Nominal power: 40W
- IP65
- Bulb included

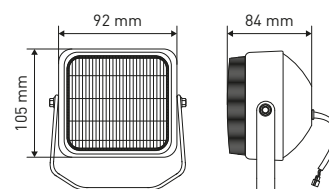

REF [100TA2273](#) – Bulb: BAY15D 48V 40W

REF [152TA2442](#) – Replacement lens

**TOTAL SOURCE®**

### REF [152TA1893](#) – 12V

- Technology: halogen
- Mounting: pedestal M10
- Wire length: 225 mm
- Nominal power: 55W
- Bulb included

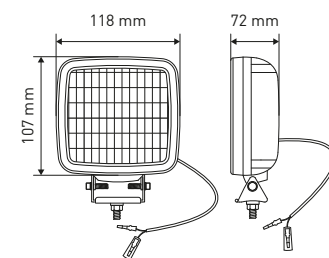

REF [161TA6105](#) – Bulb: H3 12V 55W

REF [150TA1246](#) – Replacement lens

**TOTAL SOURCE®**



## WORK LIGHTS

### REF 152TA2405

- Technology: incandescent
- Mounting: pendant
- Nominal power: 21W
- 12V
- IP55
- Bulb not included

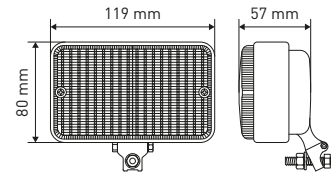

**COBO**  
*group*

REF 100TA2215 – Bulb: BA15S 12V 21W

REF 149TA8594 – Replacement lens

### REF 152TA1721 – 36V

### REF 152TA2407 – 48V

- Technology: incandescent
- Mounting: pedestal M10
- Wire length: 200 mm
- Nominal power: 25W
- 36–48V
- Bulb included

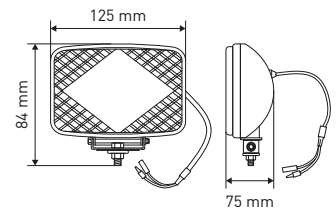
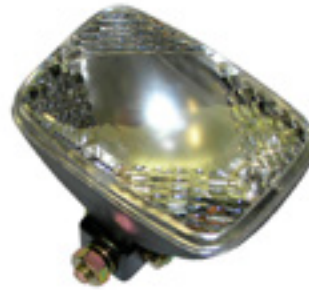

REF 122TA9125 – Bulb: BA15S 36V 25W

REF 144TA5468 – Bulb: BA15S 48V 25W

REF 152TA2408 – Replacement guard

**TOTAL SOURCE**<sup>®</sup>

### REF 152TA2410 – 12V

- Technology: halogen
- Mounting: built-in
- Nominal power: 35W
- Bulb included

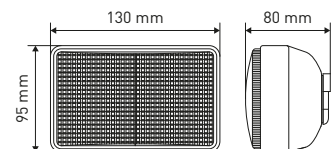

REF 142TA1228 – Bulb: PGJ13 12V 35W

**TOTAL SOURCE**<sup>®</sup>

### REF 152TA2411 – 12V

- Technology: halogen
- Mounting: pedestal M10
- Wire length: 200 mm
- Nominal power: 37,5W
- Bulb included

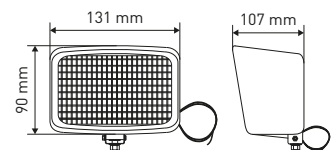

REF 144TA5518 – Bulb: PGJ13 12V 37,5W

**TOTAL SOURCE**<sup>®</sup>



## WORK LIGHTS

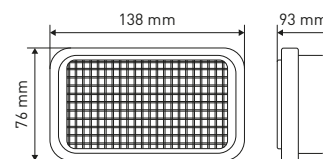

- REF 152TA2412** – 12V
- Technology: halogen
  - Mounting: built-in
  - Nominal power: 37W
  - Bulb included

**REF 122TA9145** – Bulb: PGJ13 12V 37,5W

**TOTAL SOURCE®**

BRAND: SPEAKER

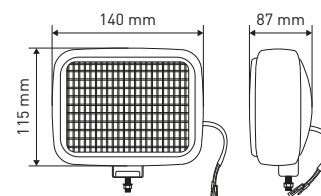

- REF 152TA2414** – 24V
- Technology: incandescent
  - Mounting: pedestal M8
  - Wire length: 150 mm
  - Nominal power: 60W
  - Bulb included

**REF 106TA4884** – Bulb: BA15S 24V 60W  
**REF 152TA2415** – Replacement lens

**TOTAL SOURCE®**

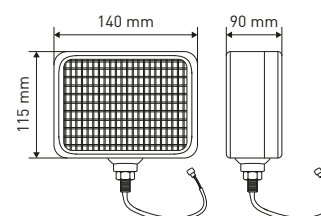

- REF 152TA2420** – 12V  
**REF 148TA7681** – 24V
- Technology: halogen
  - Mounting: pedestal M10
  - Wire length: 250 mm
  - Nominal power: 55W
  - IP64
  - Bulb included

**REF 123TA8007** – Bulb: H3 12V 55W  
**REF 161TA6106** – Bulb: H3 24V 70W  
**REF 152TA2421** – Replacement lens

**TOTAL SOURCE®**

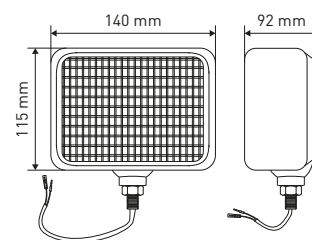

- REF 152TA2416** – 12V  
**REF 148TA9717** – 48V
- Technology: incandescent
  - Mounting: pedestal M12
  - Wire length: 200 mm
  - Nominal power: 35W
  - Bulb included

**REF 103TA4626** – Bulb: BA15S 12V 35W  
**REF 103TA4632** – Bulb: BA15S 48V 45W  
**REF 152TA2415** – Replacement lens

**TOTAL SOURCE®**



## WORK LIGHTS

**REF 152TA2419** – 56V

- Technology: incandescent
- Mounting: pedestal M8
- Wire length: 200 mm
- Nominal power: 40W
- Bulb included

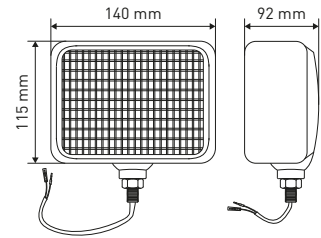

**REF 103TA4637** – Bulb: BAY15D 56V 40W

**TOTAL SOURCE**®

**REF 152TA2406** – 12V

**REF 148TA7665** – 24V

**REF 147TA3097** – 48V

- Technology: incandescent
- Mounting: pedestal M10
- Wire length: 300 mm
- Bulb included

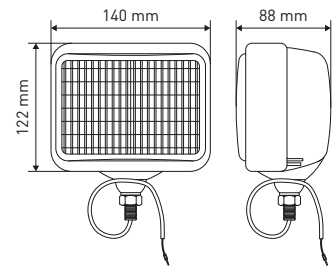

**REF 100TA2215** – Bulb: BA15S 12V 21W

**REF 103TA4630** – Bulb: BA15S 24V 36W

**REF 103TA4634** – Bulb: BA15D 48V 35W

**REF 152TA2415** – Replacement lens

**TOTAL SOURCE**®

**REF 152TA2418** – 48V

- Technology: incandescent
- Mounting: pedestal M8
- Wire length: 200 mm
- Nominal power: 40W
- IP64
- Bulb included

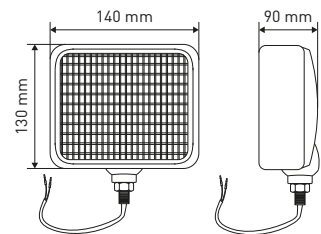

**REF 103TA4636** – Bulb: BAY15D 48V 40W

**TOTAL SOURCE**®

**REF 152TA2413** – 12V

- Technology: halogen
- Mounting: pedestal M8
- Wire length: 240 mm
- Nominal power: 37,5W
- Bulb included

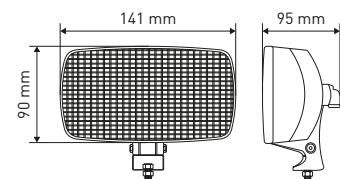

**REF 122TA9145** – Bulb: PGJ 12V 37,5W

**TOTAL SOURCE**®



## WORK LIGHTS

### REF [152TA2430](#) – 12V

- Technology: halogen
- Mounting: pedestal M10
- Wire length: 260 mm
- Nominal power: 35W
- Bulb included
- Bracket not included

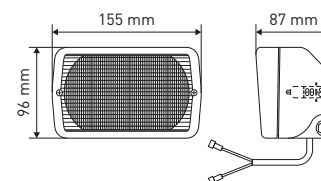

**TOTAL SOURCE**<sup>®</sup>

### REF [161TA6105](#) – Bulb: H3 12V 35W

### REF [152TA2431](#)

- Technology: halogen
- Mounting: pedestal M8
- 12–24–36–48V
- IP67
- Bulb not included
- Extra: vibration damper

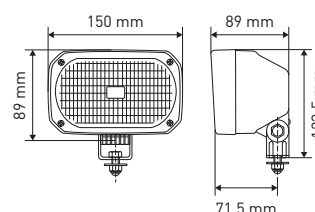

**TOTAL SOURCE**<sup>®</sup>

BRAND: NORDIC LIGHTS

### REF [161TA6105](#) – Bulb: H3 12V 55W

### REF [161TA6106](#) – Bulb: H3 24V 70W

### REF [142TA1218](#) – Bulb: H3 36V 45W

### REF [144TA5499](#) – Bulb: H3 48V 45W

### REF [152TA2402](#) – 12V

- Technology: halogen
- Mounting: pedestal M8
- Wire length: 300 mm
- Nominal power: 55W
- IP67
- Bulb included

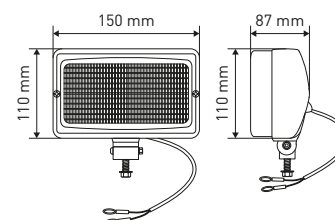

**TOTAL SOURCE**<sup>®</sup>

### REF [123TA8007](#) – Bulb: H3 12V 55W

### REF [152TA2432](#) – Without bulb

### REF [152TA2401](#) – 12V

### REF [126TA6016](#) – 24V

### REF [164TA7821](#) – 36V

- Technology: halogen
- Mounting: pedestal M10
- Wire length: 200 mm
- Bulb not included

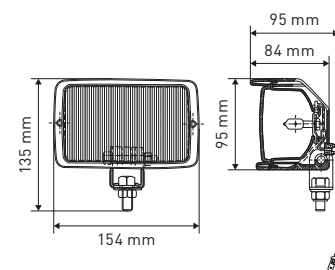

**TOTAL SOURCE**<sup>®</sup>

### REF [161TA6105](#) – Bulb: H3 12V 55W

### REF [161TA6106](#) – Bulb: H3 24V 70W

### REF [142TA1218](#) – Bulb: H3 36V 45W



## WORK LIGHTS

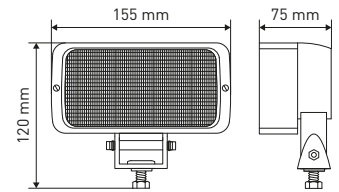

**REF 152TA2433**

- Technology: halogen
- Mounting: pedestal M10
- 12–24V
- IP5K4K
- Bulb not included

REF **123TA8007** – Bulb: H3 12V 55W

REF **161TA6106** – Bulb: H3 24V 70W

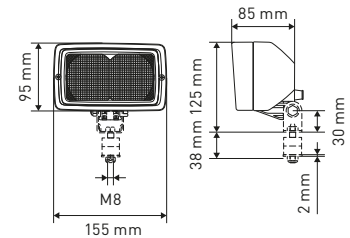

**REF 152TA2435**

- Technology: halogen
- Mounting: pedestal M8
- 12–24V
- IP54
- Bulb not included

REF **123TA8007** – Bulb: H3 12V 55W

REF **161TA6106** – Bulb: H3 24V 70W

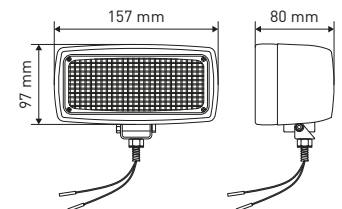

**REF 152TA2403** – 12V

- Technology: halogen
- Mounting: pedestal M10
- Wire length: 150 mm
- Nominal power: 55W
- IP65
- Bulb included

REF **123TA8007** – Bulb: H3 12V 55W

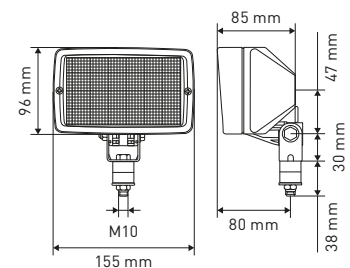

**REF 152TA2436**

- Technology: halogen
- Mounting: pedestal M8
- Extra: vibration damping
- 12–24V
- IP54
- Bulb not included

REF **123TA8007** – Bulb: H3 12V 55W

REF **161TA6106** – Bulb: H3 24V 70W







## WORK LIGHTS

**REF 152TA2437** – 12V

**REF 152TA2438** – 24V

- Technology: halogen
- Mounting: pedestal M8
- Wire length: 80 mm
- Extra: iron handle
- Bulb included

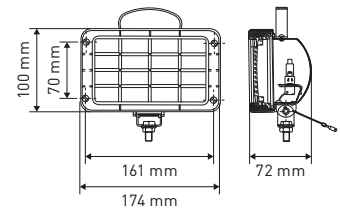

**REF 123TA8007** – Bulb: H3 12V 55W

**REF 161TA6106** – Bulb: H3 24V 70W

**TOTAL SOURCE®**

**REF 152TA2404** – 24V

- Technology: sealed beam
- Mounting: pedestal M10
- Wire length: 150 mm
- Nominal power: 60W
- Sealed beam included
- Not replaceable

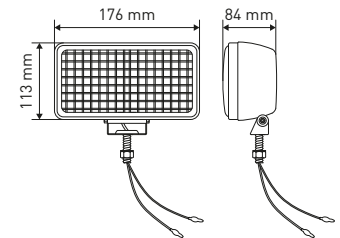

**TOTAL SOURCE®**



## WORK LIGHTS

- REF 152TA2448** – Without bulb  
**REF 164TA7941** – 12V  
**REF 148TA8199** – 24V
- Technology: halogen
  - Mounting: bracket
  - IP65
  - Bulb not included
  - Extra: 4-point bracket included

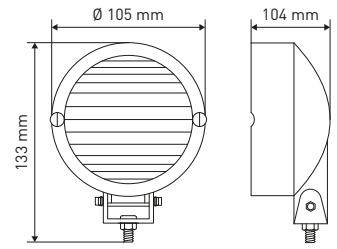

- REF 161TA6105** – Bulb: H3 12V 55W  
**REF 161TA6106** – Bulb: H3 24V 70W

**TOTAL SOURCE®**

- REF 152TA2446**
- Technology: halogen
  - Mounting: pedestal M8
  - Wire length: 140 mm
  - 12–24V
  - Bulb not included

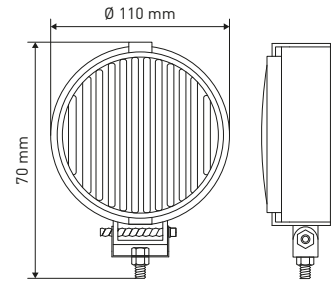

- REF 123TA8007** – Bulb: H3 12V 55W  
**REF 123TA8008** – Bulb: H3 24V 70W

**TOTAL SOURCE®**

- REF 152TA2447** – 12V
- Technology: halogen
  - Mounting: pedestal M8
  - Wire length: 240 mm
  - Nominal power: 55W
  - Bulb included

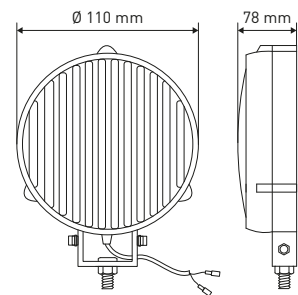

- REF 161TA6105** – Bulb: H3 12V 55W

**TOTAL SOURCE®**

- REF 152TA2450** – 12V  
**REF 152TA2451** – 24V
- Technology: sealed beam
  - Mounting: pedestal M8
  - Wire length: 230 mm
  - Sealed beam included

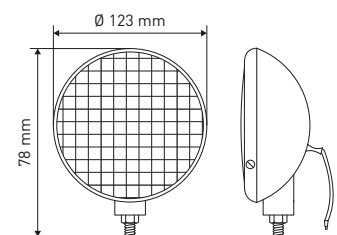

- REF 150TA2410** – Sealed beam: 12V 35W  
**REF 122TA7693** – Sealed beam: 24V 50W  
**REF 150TA6376** – Sealed beam: 24V 80W

**TOTAL SOURCE®**



## WORK LIGHTS

- REF [152TA2456](#) – 12V
- REF [152TA2457](#) – 24V
- REF [152TA2458](#) – 36V
- Technology: sealed beam
- Mounting: pedestal M10
- Wire length: 360 mm
- Sealed beam included

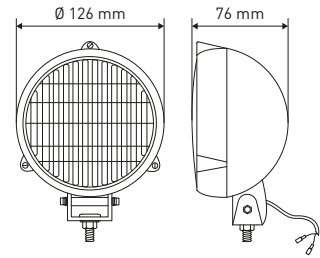

- REF [106TA1269](#) – Sealed beam: 12V 35 W
- REF [122TA7693](#) – Sealed beam: 24V 50W
- REF [131TA8892](#) – Sealed beam: 36V 60W

**TOTAL SOURCE®**

- REF [152TA2460](#) – 12V
- Technology: incandescent
- Mounting: pedestal M10
- Wire length: 160 mm
- Nominal power: 35W
- Bulb included

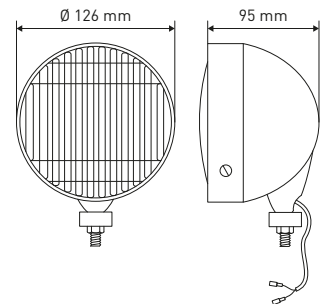

- REF [142TA1295](#) – Bulb: P15D 12V 35/35W
- REF [152TA2461](#) – Replacement lens

**TOTAL SOURCE®**

- REF [152TA2452](#) – 12V
- REF [152TA2453](#) – 24V
- REF [152TA2454](#) – 36V
- REF [152TA2455](#) – 48V
- Technology: halogen
- Mounting: pedestal M8
- Wire length: 150 mm
- Bulb included

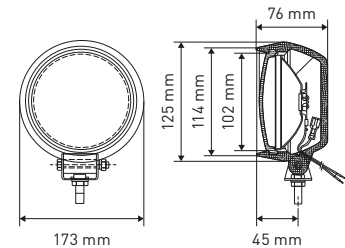

- REF [123TA8007](#) – Bulb: H3 12V 55W
- REF [123TA8008](#) – Bulb: H3 24V 70W
- REF [123TA8009](#) – Bulb: H3 36V 45W
- REF [123TA8010](#) – Bulb: H3 48V 45W

**TOTAL SOURCE®**

- REF [152TA2465](#) – 12V
- Technology: sealed beam
- Mounting: pedestal M10
- Wire length: 250 mm
- Nominal power: 35W
- Sealed beam not replaceable

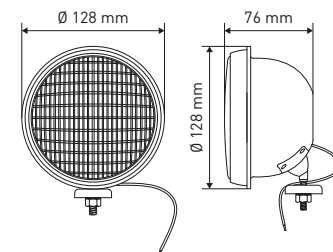

- REF [150TA2410](#) – Sealed beam: 12V 35 W
- REF [152TA2493](#) – Protection support

**TOTAL SOURCE®**



## WORK LIGHTS

- REF 152TA2462** – 12V  
**REF 152TA2463** – 24V
- Technology: incandescent
  - Mounting: pedestal M10
  - Wire length: 200 mm
  - Nominal power: 48W

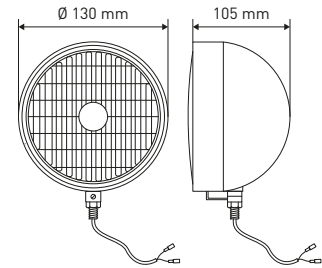

- REF 131TA4781** – Bulb: BA15D 12V 36W  
**REF 131TA4783** – Bulb: BA15D 24V 36W

**TOTAL SOURCE®**

- REF 152TA2464** – 12V
- Technology: incandescent
  - Mounting: pedestal M12
  - Wire length: 1400 mm
  - Nominal power: 35W
  - Bulb included

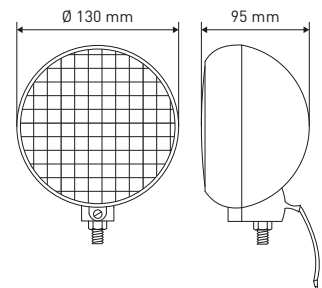

- REF 106TA1267** – Bulb: BA20D 12V 35W  
**REF 149TA7846** – Replacement lens and mirror

**TOTAL SOURCE®**

- REF 152TA2466**
- Technology: incandescent
  - Mounting: central bolt
  - 12–24V
  - Bulb not included

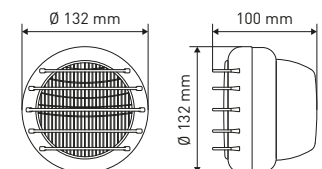

- REF 123TA7997** – Bulb: BA20D 12V 35W  
**REF 122TA9135** – Bulb: BA20D 24V 25W



- REF 152TA2468** – 12V
- Technology: halogen
  - Mounting: pedestal M12
  - Wire length: 300 mm
  - Nominal power: 55W
  - Bulb included

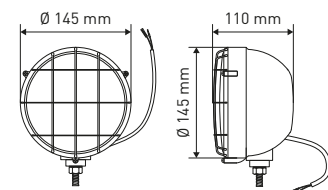

- REF 123TA8007** – Bulb: H3 12V 55W  
**REF 152TA2469** – Optical unit  
**REF 152TA2470** – Protection guard  
**REF 152TA2492** – Protection support

**TOTAL SOURCE®**



## WORK LIGHTS

### REF 152TA2472

- Technology: halogen
- Mounting: pedestal M12
- Nominal power: 45W
- 12–24V
- Bulb not included

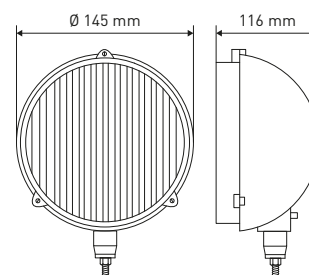

REF 106TA4826 – Bulb: R2 12V 40/45W

REF 106TA4827 – Bulb: R2 24V 50/50W

REF 152TA2473 – Optical unit



### REF 152TA2474

- Technology: halogen
- Mounting: 2-point bracket
- 12–24V
- Bulb not included
- Extra: handle and on/off switch

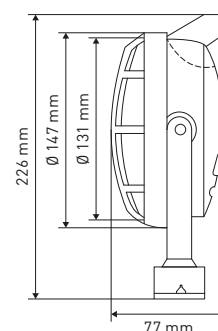

REF 123TA8007 – Bulb: H3 12V 55W

REF 123TA8008 – Bulb: H3 24V 70W

**TOTAL SOURCE®**

REF 152TA2485 – 12V

REF 152TA2486 – 24V

- Technology: incandescent
- Mounting: 4-point bracket
- Wire length: 100 mm
- Bulb included
- Extra: on/off switch

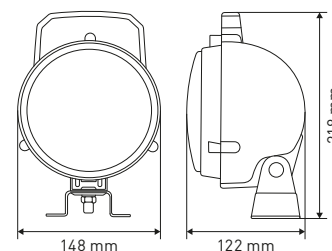

REF 161TA6096 – Bulb: BA20S 12V 35W

REF 141TA9895 – Bulb: BA20S 24V 35W

REF 152TA2494 – Optical unit

**TOTAL SOURCE®**

REF 152TA2476 – Without hand grip

REF 152TA2477 – With hand grip

- Technology: halogen
- Mounting: pedestal M10
- 12–24V
- IP5K4K
- Bulb not included

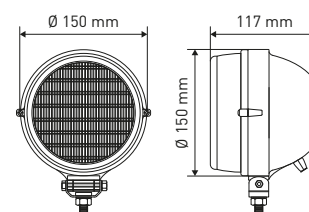

REF 123TA8007 – Bulb: H3 12V 55W

REF 123TA8008 – Bulb: H3 24V 70W





## WORK LIGHTS

### REF 152TA2480

- Technology: halogen
- Mounting: pedestal M12
- 12-24V
- IP54
- Bulb not included

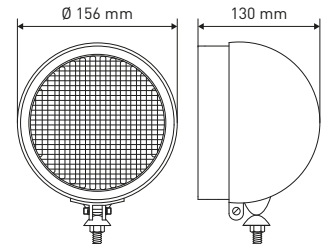

REF 123TA8007 – Bulb: H3 12V 55W

REF 123TA8008 – Bulb: H3 24V 70W

REF 152TA2481 – Optical unit

**TOTAL SOURCE®**

REF 152TA2483 – 12V

REF 152TA2484 – 24V

- Technology: halogen
- Mounting: 2 point bracket
- Extra: protection guard and on/off switch
- Bulb included

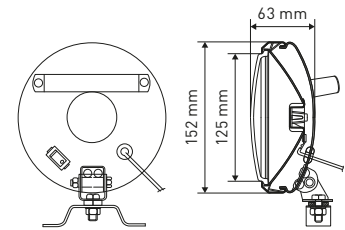

REF 123TA8007 – Bulb: H3 12V 55W

REF 123TA8008 – Bulb: H3 24V 70W

**TOTAL SOURCE®**

REF 152TA1719 – 12V LH

REF 152TA1718 – 12V RH

- Technology: halogen
- Mounting: built-in
- Used on Bobcat
- Bulb included

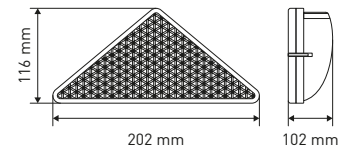

REF 122TA9146 – Bulb: PGJ13 12V 50W

**TOTAL SOURCE®**



# PORTABLE LIGHTS



## NICE TO KNOW – PORTABLE LIGHTS



The lights in this chapter (torches, signalling lights ...) are useful tools suitable for use during different situations. These are mobile lights that can easily be moved and deployed.

Find the correct light for any situation:

- **torches** to always have at hand
- **worklights** and **head lamps** to allow you to work hands-free
- **signalling lights** to indicate works or demarcate an area
- **searchlights** to easily track something





## PENLIGHT

### REF 144TA8716

- 6+1 SMD/LED work light with clip, portable and convenient
- 6 pcs super bright SMD (3528) as task light, 1 super bright LED on the top as torch
- Unit size: 17 cm length
- With magnet on the clip

#### Application:

Road, car repair, factory, work place, camping, hiking, boating, home etc



### REF 145TA8828

Box of 12 penlights

REF 144TA5953 – Replacement batteries

## LED HANDHELD TORCH LIGHTS

### REF 163TA8540

- Light output: 250 lumen
- Housing: aluminium
- 3 lighting modes: turbo/general/strobe
- Waterproof up to 100 m (300 ft)
- 10° spot beam and 25° flood beam
- Total length: 130 mm
- IP68



REF 144TA5953 – Replacement batteries

### REF 139TA3253

- Light output: more than 210 lumen
- Housing: aluminium
- High powered LED 5W
- Rechargeable lithium-ion battery with 23VAC EU charger
- Waterproof
- 15° lens
- Total length: 150 mm
- 3 lighting modes: turbo/general/strobe



### REF 164TA8075

- Light output: 810 lumen
- 10W powered LED
- 3 mode of light: power max, ECO, flashing
- Adaptor: AC 110 – 220V – 50/60 Hz
- Rechargeable battery: 4V 9AH
- Autonomy max: 7 h/13 h





## LED SEARCH LIGHT

### REF 143TA7112

New Technology – searchlight with innovative optical design (Magic Lens) & high intensity LED light source array

- With 4 high powered 10W CREE LEDs
- 14,4V 5,000 mAh Li-ion battery pack – with charging & over discharging protection
- With flood lens + 400 m scope
- 4 Modes power output – 100%, 50%, 25% & flash
- Shock-resistant nylon housing
- Heat-resistant
- Carrying case with accessories: battery, AC-charger, strap, flood lens
- Dimensions (L x W x H): 268 x 114 x 147 mm
- IP55



## LED HANDHELD WORK LIGHTS

### REF 139TA3256

- 60 LED handheld work lamp
- Working time: up to 4 hours on a full charge
- With charge indicator & universal AC-charger
- With swivel hooks and charge base
- Total length: 390 mm



### REF 139TA3257

- 30 LED handheld work lamp
- Working time: up to 4 hours on a full charge
- With charge indicator & universal AC-charger
- With rubber surface cover
- Total length: 285 mm





## LED WORK LAMP SET

### REF [139TA3793](#)

#### Contents:

- REF 139TA3256: 60 LED handheld work lamp + charger
- REF 139TA3257: 30 LED handheld work lamp + charger
- REF 139TA3258: head light



## RECHARGEABLE LED WORKLIGHT

### REF [164TA9699](#)

- Technology: LED
- Nominal power: 15W
- Operating light output (100%): 1080 lumen
- LED: 5 pieces
- Housing: aluminium
- Lens: polycarbonate
- Autonomy: 3-4 h (100% brightness)
- IP67
- 240V EU charger & 12V car plug charger included



## MAGNETIC MINI WORKLIGHT

### REF [164TA1549](#)

- Technology: LED
- Length: 155 mm
- Wire length: 100 mm
- 100-240V
- IP20
- Rechargeable via USB
- USB-cable included



## LED TORCH - WARNING COMBINATION LIGHT

### REF [139TA3255](#)

- LED nominal power: 3W
- Light output: up to 250 lumen
- Waterproof
- Holder with magnetic base and removable warning signal cover
- Super compact: total length 120 mm without/190 mm with emergency cover



REF [144TA5953](#) – Replacement batteries



## WORKLAMPS

### REF [107TA7550](#)

- Dimensions: 495 x 110 x 285 mm
- Wire length: 5 m rubber cable
- Shock-resistant
- 230V 50 Hz
- 72W (2 x 36W TC-L) = 300W light output
- IP54 splashproof
- Diffuser and casing made of impact-resistant material
- Multipositional arm
- 2 x 230V safety sockets on the back



### REF [107TA7546](#)

- TL worklamp
- 230V/8W
- IP20
- 5 m cable



## SAFETY INSPECTION

### REF [107TA7549](#)

- 10 m cable
- Insulated handgrip: oil-, acid- and solvent-resistant
- Reflecting cage made of zinc-coated steel
- Rotating hanging-hook
- IP20
- Bulb not included (bulb: REF 140TA8363 – E27 220V 60W max)



## LED STROBE LIGHT

### REF [107TA8121](#)

- Technology: LED
- Ø 187 mm
- Length: 192 mm
- Height: 348 mm
- 6V
- Battery not included
- Bulb included

REF [151TA3827](#) – Battery

REF [151TA3828](#) – Key





## ROAD MARKER

### REF 163TA8810

- Technology: LED
- Mounting: portable
- Length: 500 mm
- Width: 500 mm
- Height: 500 mm
- Wire length: 3000 mm
- 12-24V
- Battery not included
- Sealed bulb



## PORTABLE FLOOD LIGHTS

### REF 152TA2490

- Technology: LED
- Mounting: portable
- Length: 75 mm
- Width: 95 mm
- Height: 100 mm
- 12-24V
- UK & European charger and car plug included (REF 164TA9696)
- Theoretical output: 900 lumen
- Nominal power: 10W
- IP65



### REF 152TA2489

- Technology: LED
- Mounting: portable
- Length: 325 mm
- Width: 190 mm
- Height: 370 mm
- 12-24V
- UK & European charger and car plug included (REF 164TA9696)
- Theoretical output: 1800 lumen
- Nominal power: 20W
- IP65



## MOBILE AKKU CHIP LED LIGHT

### REF 152TA2487

- Technology: LED
- For installation indoors and outdoors
- Nominal power: 10W
- Luminous flux: 650 lumen
- IP54
- Rechargeable battery: 11,1V/2200 mAh





## MOBILE CHIP LED LIGHT

### REF 152TA2488

- Technology: LED
- For installation indoors and outdoors
- Stable steel tube frame with ergonomically preformed handles
- Nominal power: 50W
- Light output: 3500 lumen
- IP65
- Input voltage: 230VAC EU-plugin



## FLOOD LIGHT

### REF 164TA1550

- Technology: halogen
- For installation indoors and outdoors
- Mounted on stable ground tripod
- Nominal power: 400W
- Dimmer included
- Input voltage: 230VAC EU-plugin





**PREMIUM BULBS**



## NICE TO KNOW – PREMIUM BULBS



### Philips car lighting, the ultimate choice for the road

Light can help us feel safe when on the road. Bright, clear headlights improve visibility without blinding other drivers with glare. Precise in-car lighting adds comfort without distracting the person who's driving. For nearly a century, Philips Automotive has been dedicated to providing the best in-class lighting solutions in the Aftermarket and Original Equipment Manufacturer and Supplier (OEM, OES) markets. One out of every three cars around the world comes equipped with Philips bulbs.

Philips car lighting, the ultimate choice for the road

- Innovator for car lighting since 1914
- Inventor of the xenon HID lighting
- The preferred choice of leading car manufacturers

Philips is the only supplier who offers all its bulbs in quartz glass (instead of hardened glass).

#### Advantages:

- Higher pressure-resistance, better light distribution
- Higher resistance against thermal shocks
- UV-protection. Prevents optics from 'turning yellow'





## BA9S

U1 (V)	P1 (W)	REF
12	2	<a href="#">163TA8251</a>
12	4	<a href="#">145TA2682</a>
24	2	<a href="#">163TA8252</a>
24	4	<a href="#">160TA1133</a>

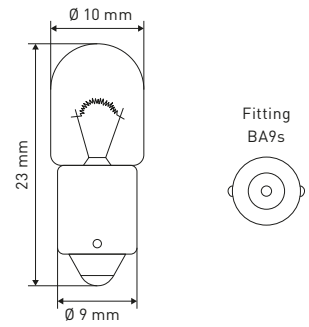

**PHILIPS**

## BA15S TUBULAR

U1 (V)	P1 (W)	REF
12	5	<a href="#">145TA2680</a>
12	10	<a href="#">145TA2676</a>
24	5	<a href="#">160TA1131</a>
24	10	<a href="#">160TA1130</a>

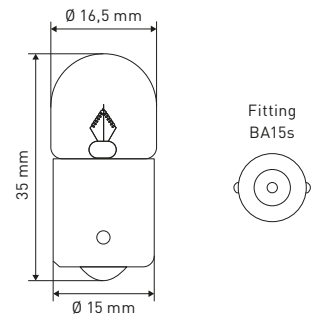

**PHILIPS**

## BA15S

U1 (V)	P1 (W)	REF
12	21	<a href="#">145TA2673</a>
24	21	<a href="#">145TA2674</a>

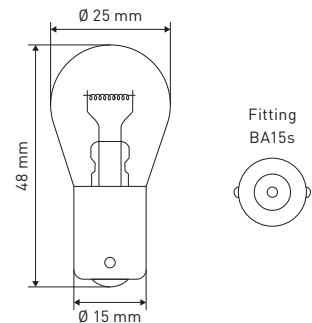

**PHILIPS**

## BA15S SPHERICAL

U1 (V)	P1 (W)	REF
12	18	<a href="#">163TA8253</a>

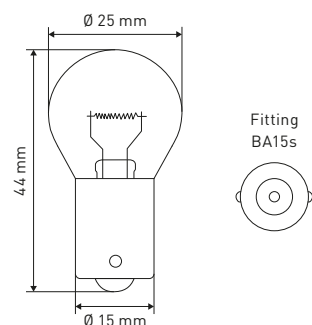

**PHILIPS**



## BAY15D

U1 (V)	P1 (W)	P2 (W)	REF
12	21	5	<a href="#">145TA2099</a>
24	21	5	<a href="#">145TA2686</a>

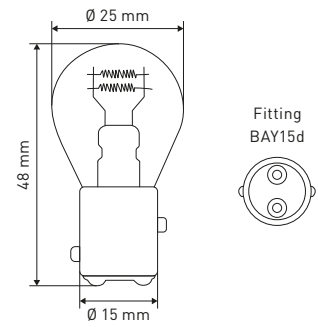

**PHILIPS**

## BAU15S

U1 (V)	P1 (W)	REF
12	21	<a href="#">160TA1124</a>

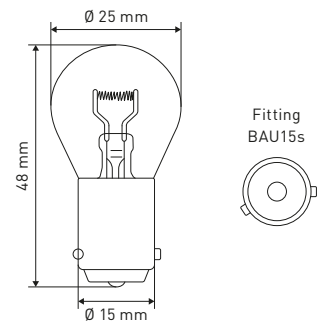

**PHILIPS**

## H1

U1 (V)	P1 (W)	REF
12	55	<a href="#">145TA2684</a>
24	70	<a href="#">163TA8254</a>

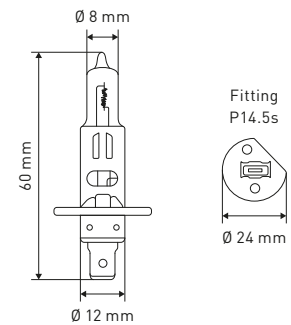

**PHILIPS**

## H3

U1 (V)	P1 (W)	REF
12	55	<a href="#">145TA2675</a>
24	70	<a href="#">145TA2677</a>

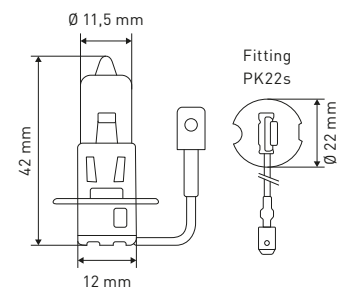

**PHILIPS**



## H4

U1 (V)	P1 (W)	P2 (W)	REF
12	60	55	<a href="#">160TA1121</a>
24	75	70	<a href="#">160TA1129</a>

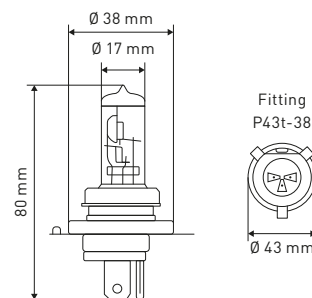

**PHILIPS**

## H7

U1 (V)	P1 (W)	REF
12	55	<a href="#">145TA2681</a>
24	70	<a href="#">160TA1135</a>

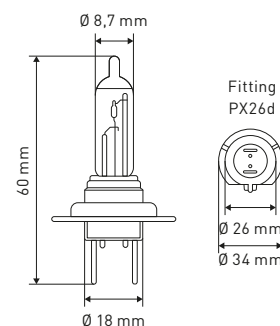

**PHILIPS**

## R2

U1 (V)	P1 (W)	P2 (W)	REF
12	45	40	<a href="#">145TA2685</a>
24	55	50	<a href="#">163TA8255</a>

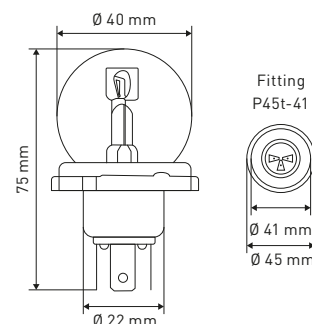

**PHILIPS**

## SV8.5-8

U1 (V)	P1 (W)	REF
12	5	<a href="#">160TA1122</a>
12	10	<a href="#">163TA8256</a>
24	5	<a href="#">160TA1132</a>
24	10	<a href="#">163TA8257</a>

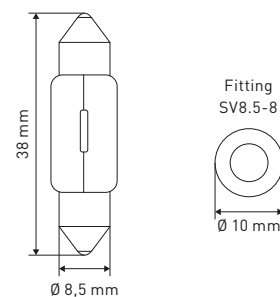

**PHILIPS**



## SV8.5-8

U1 (V)	P1 (W)	REF
12	5	<a href="#">163TA8258</a>
12	10	<a href="#">145TA2683</a>
24	5	<a href="#">163TA8259</a>
24	10	<a href="#">163TA8260</a>

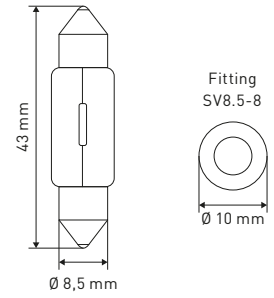

**PHILIPS**

U1 (V)	P1 (W)	REF
24	18	<a href="#">145TA2678</a>

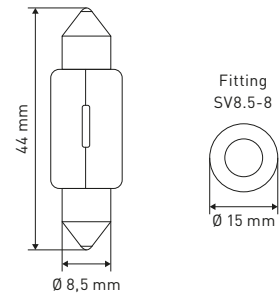

**PHILIPS**

## W2.1X9.5D

U1 (V)	P1 (W)	REF
12	3	<a href="#">163TA8263</a>
12	5	<a href="#">160TA1125</a>
24	3	<a href="#">163TA8262</a>
24	5	<a href="#">161TA5953</a>

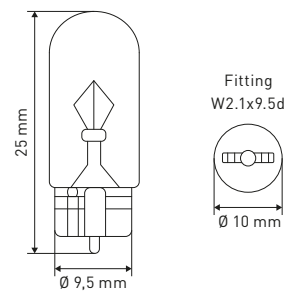

**PHILIPS**

## W2X4.6D

U1 (V)	P1 (W)	REF
12	1,2	<a href="#">145TA2679</a>
12	2	<a href="#">161TA5954</a>
24	1,2	<a href="#">163TA8264</a>
24	2	<a href="#">163TA8265</a>

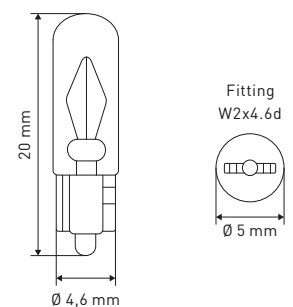

**PHILIPS**



## P13W

U1 (V)	P1 (W)	REF
12	13	<a href="#">161TA5900</a>

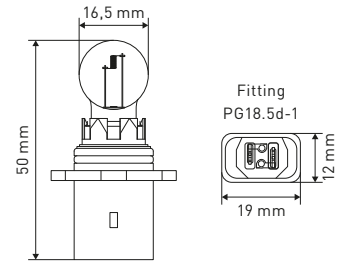

**PHILIPS**

## PS19W

U1 (V)	P1 (W)	REF
12	19	<a href="#">161TA5901</a>

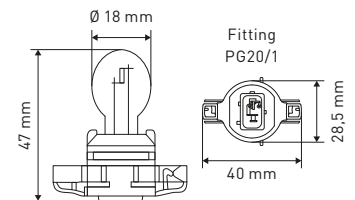

**PHILIPS**

## PSY19W

U1 (V)	P1 (W)	Remark	REF
12	19	Orange	<a href="#">161TA5902</a>

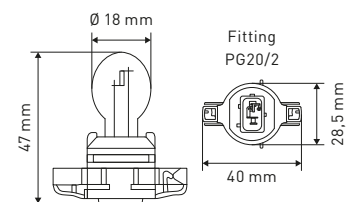

**PHILIPS**

## PS24W

U1 (V)	P1 (W)	REF
12	24	<a href="#">142TA1251</a>

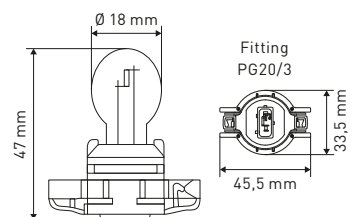

**PHILIPS**



## PSY24W

U1 (V)	P1 (W)	Remark	REF
12	24	Orange	<a href="#">161TA5903</a>

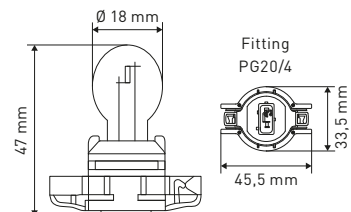

**PHILIPS**

## D1S (XENON)

U1 (V)	P1 (W)	REF
85	35	<a href="#">147TA4297</a>

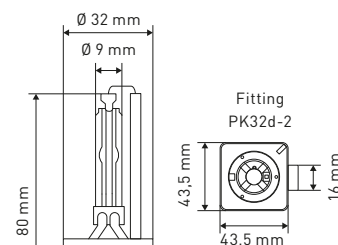
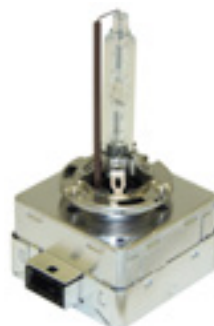

**PHILIPS**

## D1R (XENON)

U1 (V)	P1 (W)	REF
85	35	<a href="#">147TA4299</a>

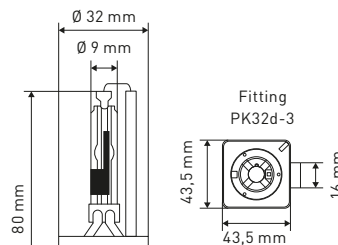

**PHILIPS**

## D2S (XENON)

U1 (V)	P1 (W)	REF
85	35	<a href="#">147TA4300</a>

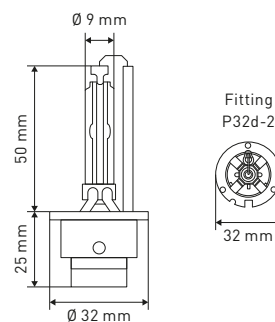

**PHILIPS**



## D2R (XENON)

U1 (V)	P1 (W)	REF
85	35	<a href="#">147TA4302</a>

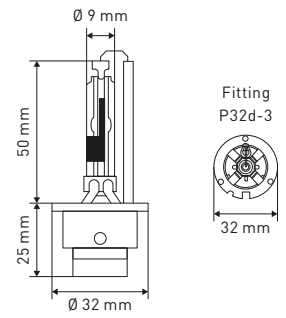

**PHILIPS**



NOTES

A series of horizontal dotted lines for writing notes.





# FLASHTUBES



## NICE TO KNOW – FLASHTUBES



A flashtube works via a short discharge through a special gas discharge bulb filled with xenon gas. The required energy is first stored in a capacitor. A small converter and transformer deliver the correct voltage, as the voltage of the capacitor is in principle not high enough to ignite the tube. That is why an extra electrode is added to generate a power surge that allows the ignition.



**Picture 1:** The power surge ionises the gas.



**Picture 2:** The capacitor lets the current charge flow through the tube which causes a reaction with the xenon gas.



**Picture 3:** As the resistance drops, the tube fills up with xenon, which is now in a plasma state.



**Picture 4:** The full current now flows through the tube and radiates light.



## FLASHTUBES

Connections	REF
3	<a href="#">160TA1088</a>

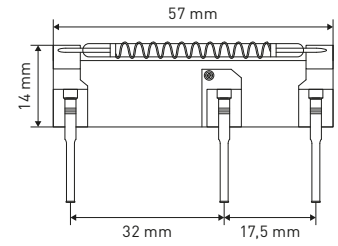

Connections	REF
3	<a href="#">142TA1279</a>

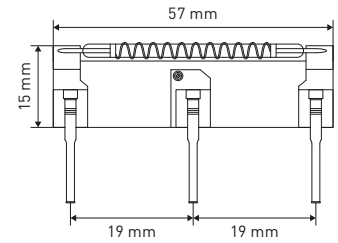

Connections	REF
3	<a href="#">151TA3674</a>

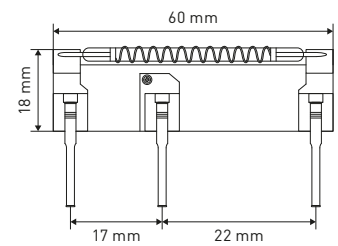

Connections	REF
3	<a href="#">106TA9126</a>

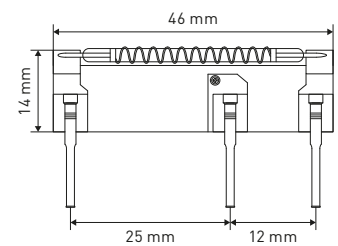



## FLASHTUBES

Connections	REF
3	<a href="#">126TA6121</a>

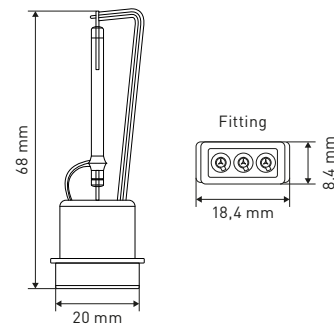

Connections	REF
3	<a href="#">151TA3766</a>

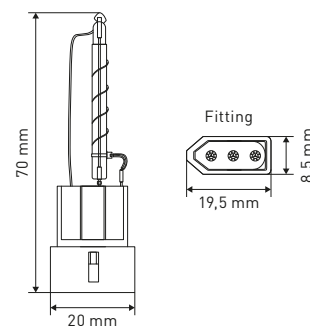

Connections	REF
3	<a href="#">142TA1342</a>

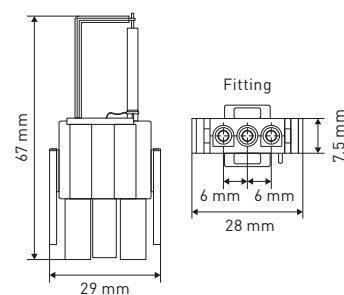

Connections	REF
3	<a href="#">134TA2345</a>

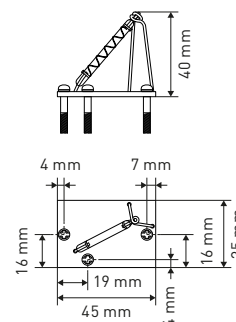
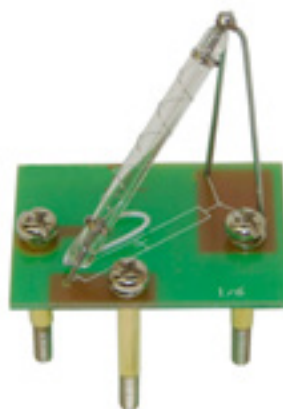



## FLASHTUBES

Connections	REF
3	<a href="#">116TA5655</a>

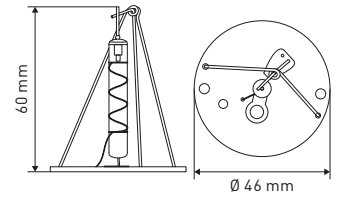

Connections	REF
3	<a href="#">151TA3707</a>

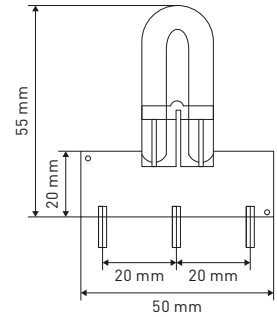
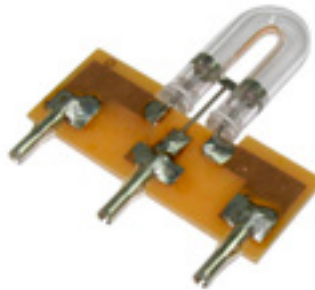

Connections	REF
3	<a href="#">142TA1340</a>

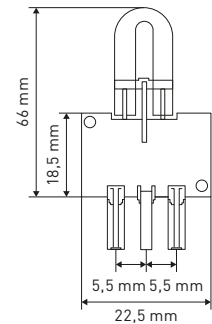

Connections	REF
3	<a href="#">142TA1144</a>

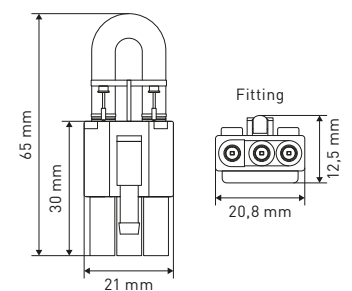



## FLASHTUBES

Connections	REF
3	<a href="#">151TA3713</a>

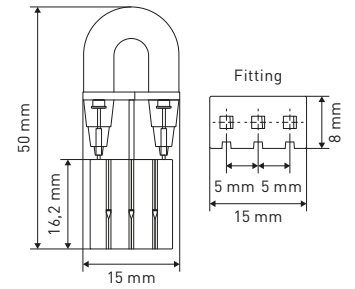

Connections	REF
3	<a href="#">144TA5708</a>

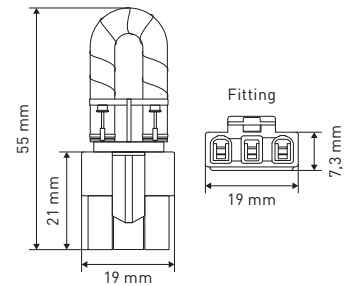



# INCANDESCENT BULBS



## NICE TO KNOW – INCANDESCENT BULBS



To this day, incandescent bulbs are the second most used bulbs in the world after fluorescent bulbs.

**Advantages:**

- Great to illuminate small areas
- Cheap to produce
- Can easily be adjusted (e.g.: dimmer)
- No chemical materials required

**Disadvantages:**

- Not energy-efficient:
  - 90% of the energy is lost in heat while only 10% of the energy is converted to light
  - Not ideal for larger spaces

**Functioning:**

When a current flows through a filament in a low-oxygen environment, a light source is created. As soon as the light bulb is connected to a suitable tension, this piece of metal heats up so strongly that it emits visible light.

A glass bulb, in which very little to no oxygen is present, protects the filament from burning. If the filament comes in contact with oxygen from the ambient air due to damage to the bulb, it will burn within one second after the light is switched on.





## MIDGET GROOVED T1 3/4

U1 (V)	P1 (W)	REF
14	1,12	<a href="#">103TA4563</a>
28	1,12	<a href="#">131TA4743</a>

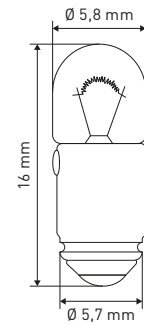

Fitting  
T1 3/4

## MIDGET FLANGED T1 3/4

U1 (V)	P1 (W)	REF
12	1,2	<a href="#">152TA2514</a>
14	1,12	<a href="#">141TA9705</a>
28	1,12	<a href="#">141TA9706</a>

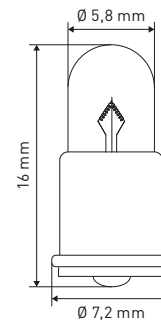

Fitting  
T1 3/4

## BA7S

U1 (V)	P1 (W)	REF
6	0,6	<a href="#">106TA4839</a>
12	2	<a href="#">123TA8015</a>
12	4	<a href="#">152TA2515</a>
24	2	<a href="#">131TA4741</a>
24	3	<a href="#">103TA4560</a>
36	1,2	<a href="#">141TA9701</a>
36	1,8	<a href="#">131TA4742</a>
48	2	<a href="#">119TA8911</a>
60	1,2	<a href="#">103TA4561</a>

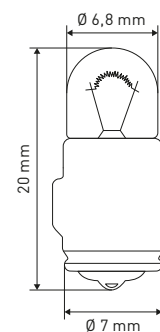

Fitting  
BA7s



## BA9S

U1 (V)	P1 (W)	REF
6	1,5	<a href="#">152TA2516</a>
6	2	<a href="#">103TA4573</a>
12	2	<a href="#">103TA4574</a>
12	3	<a href="#">103TA4571</a>
12	5	<a href="#">115TA4601</a>
24	2	<a href="#">103TA4576</a>
24	3	<a href="#">131TA4748</a>
24	4	<a href="#">103TA4577</a>
30	3	<a href="#">131TA4750</a>
36	2,5	<a href="#">106TA4898</a>
48	2	<a href="#">123TA7978</a>
48	2,5	<a href="#">123TA7979</a>
80	1,6	<a href="#">119TA8914</a>

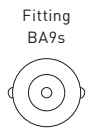
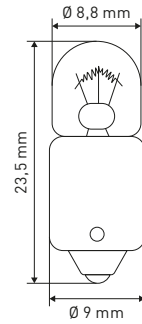

Fitting  
BA9s

U1 (V)	P1 (W)	REF
12	4	<a href="#">103TA4572</a>
24	4	<a href="#">106TA4840</a>
48	2	<a href="#">106TA4844</a>
80	2	<a href="#">131TA4747</a>
130	2,6	<a href="#">106TA4841</a>

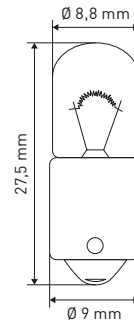

Fitting  
BA9s



## BA9S

U1 (V)	P1 (W)	REF
12	2	<a href="#">131TA4758</a>
12	4	<a href="#">122TA9116</a>
12	5	<a href="#">122TA9117</a>
24	2	<a href="#">122TA9118</a>
24	3	<a href="#">103TA4580</a>
24	5	<a href="#">106TA4849</a>
28	5	<a href="#">159TA9759</a>
30	2	<a href="#">131TA4760</a>
36	1,8	<a href="#">131TA4761</a>
48	2	<a href="#">131TA4762</a>
48	2,4	<a href="#">141TA9755</a>
48	3	<a href="#">131TA4763</a>
48	4	<a href="#">119TA8915</a>
48	5	<a href="#">123TA7981</a>
60	2	<a href="#">131TA4755</a>
80	3	<a href="#">141TA9758</a>
130	2,6	<a href="#">131TA4756</a>
240	2,4	<a href="#">131TA4757</a>

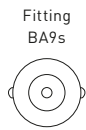
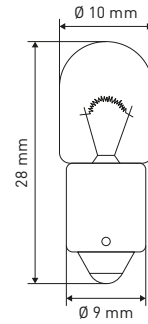

Fitting  
BA9s

U1 (V)	P1 (W)	REF
6	6	<a href="#">141TA9739</a>
12	1,5	<a href="#">106TA4845</a>
12	2	<a href="#">131TA4754</a>
12	3	<a href="#">106TA4846</a>
12	3,4	<a href="#">103TA4578</a>
12	5	<a href="#">103TA4579</a>
24	2,8	<a href="#">141TA9740</a>
24	5	<a href="#">106TA4848</a>
30	2	<a href="#">131TA4752</a>
30	3	<a href="#">131TA4753</a>

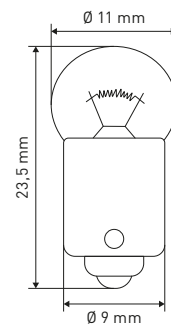

Fitting  
BA9s



## BA9S

U1 (V)	P1 (W)	Remark	REF
6	5		<a href="#">103TA4564</a>
12	3		<a href="#">103TA4565</a>
12	3	Red	<a href="#">141TA9710</a>
12	3,4		<a href="#">122TA9114</a>
12	5		<a href="#">141TA9717</a>
12	6		<a href="#">103TA4566</a>
12	7,5		<a href="#">122TA9115</a>
24	4		<a href="#">103TA4568</a>
24	5		<a href="#">103TA4569</a>
48	2,5		<a href="#">119TA8912</a>
48	3,5		<a href="#">131TA4744</a>
48	5		<a href="#">131TA4745</a>

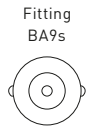
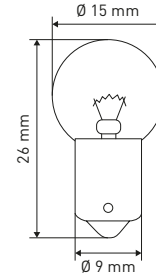

Fitting  
BA9s

## BA15S SPHERICAL

U1 (V)	P1 (W)	Remark	REF
6	5		<a href="#">103TA4584</a>
12	3		<a href="#">122TA9119</a>
12	5		<a href="#">123TA7982</a>
12	10		<a href="#">123TA7983</a>
12	15		<a href="#">106TA4853</a>
12	20		<a href="#">159TA9760</a>
24	5		<a href="#">103TA4587</a>
24	5	Heavy-duty	<a href="#">141TA9768</a>
24	10		<a href="#">123TA7984</a>
24	15		<a href="#">131TA4764</a>
36	10		<a href="#">106TA4856</a>
48	8		<a href="#">103TA4589</a>
48	10		<a href="#">123TA7985</a>

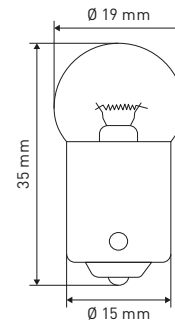

Fitting  
BA15s

## BA15S TUBULAR

U1 (V)	P1 (W)	REF
6	5	<a href="#">115TA4603</a>
12	5	<a href="#">115TA4602</a>
12	10	<a href="#">103TA4596</a>
24	5	<a href="#">103TA4597</a>
24	10	<a href="#">106TA4860</a>

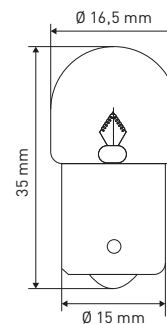

Fitting  
BA15s



## BA15D SPHERICAL

U1 (V)	P1 (W)	REF
6	10	<a href="#">119TA8916</a>
12	5	<a href="#">103TA4593</a>
12	10	<a href="#">123TA8034</a>
12	15	<a href="#">131TA4765</a>
24	5	<a href="#">103TA4595</a>
24	10	<a href="#">106TA4857</a>
24	15	<a href="#">131TA4766</a>
48	8	<a href="#">106TA4859</a>
48	10	<a href="#">119TA8917</a>

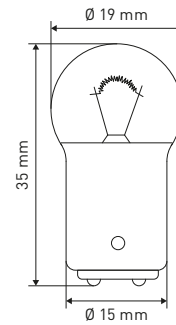

Fitting  
BA15d

## BA15D TUBULAR

U1 (V)	P1 (W)	REF
6	5	<a href="#">159TA9761</a>
12	5	<a href="#">159TA9762</a>
12	10	<a href="#">159TA9763</a>
24	5	<a href="#">159TA9764</a>

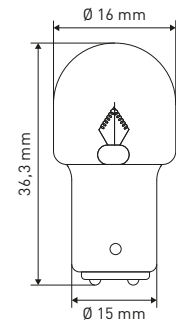

Fitting  
BA15d

## BAY15D SPHERICAL

U1 (V)	P1 (W)	REF
36	8	<a href="#">122TA9120</a>
48	8	<a href="#">131TA4767</a>
48	10	<a href="#">123TA7986</a>
60	10	<a href="#">103TA4600</a>

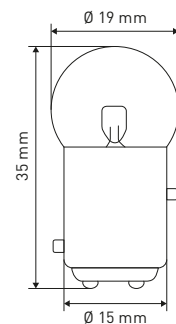

Fitting  
BAY15d



## BA15S

U1 (V)	P1 (W)	Remark	REF
6	21		<a href="#">119TA8920</a>
12	15		<a href="#">131TA4770</a>
12	18		<a href="#">106TA4861</a>
12	21		<a href="#">100TA2215</a>
12	21	Orange	<a href="#">122TA9122</a>
12	25		<a href="#">103TA4602</a>
12	27		<a href="#">163TA8241</a>
24	15		<a href="#">142TA3650</a>
24	18		<a href="#">131TA4772</a>
24	21	Orange	<a href="#">103TA4603</a>
24	21		<a href="#">142TA3656</a>
24	25		<a href="#">103TA4604</a>
24	35		<a href="#">106TA4863</a>
36	10		<a href="#">122TA9124</a>
36	25		<a href="#">122TA9125</a>
48	10		<a href="#">119TA8918</a>
48	15		<a href="#">122TA9126</a>
48	23		<a href="#">141TA9805</a>
48	25		<a href="#">123TA7987</a>
48	35		<a href="#">131TA4768</a>
48	45		<a href="#">131TA4769</a>
56	25		<a href="#">141TA9809</a>

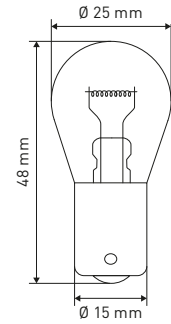

Fitting  
BA15s

U1 (V)	P1 (W)	REF
6	15	<a href="#">103TA4605</a>

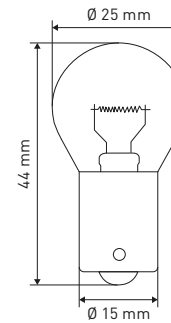

Fitting  
BA15s



## BA15S

U1 (V)	P1 (W)	REF
12	35	<a href="#">103TA4626</a>
12	45	<a href="#">123TA7993</a>
24	35	<a href="#">141TA9858</a>
24	40	<a href="#">103TA4631</a>
24	45	<a href="#">106TA4883</a>
24	60	<a href="#">106TA4884</a>
48	45	<a href="#">103TA4632</a>
80	25	<a href="#">103TA4633</a>

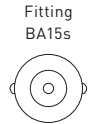
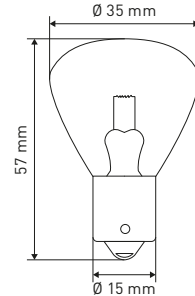

U1 (V)	P1 (W)	REF
12	36	<a href="#">141TA9854</a>
24	36	<a href="#">141TA9856</a>
24	48	<a href="#">141TA9855</a>
24	60	<a href="#">123TA7994</a>

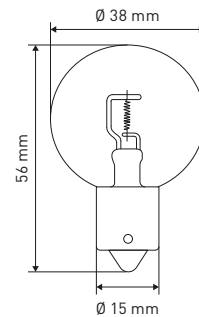

## BA15D

U1 (V)	P1 (W)	REF
6	21	<a href="#">159TA9949</a>
12	10	<a href="#">103TA4610</a>
12	15	<a href="#">131TA4775</a>
12	21	<a href="#">103TA4611</a>
12	25	<a href="#">115TA4605</a>
24	21	<a href="#">103TA4613</a>
36	10	<a href="#">142TA3651</a>
36	25	<a href="#">141TA9825</a>
40	15	<a href="#">115TA4604</a>
48	10	<a href="#">119TA8919</a>
48	25	<a href="#">103TA4614</a>
48	35	<a href="#">131TA4774</a>

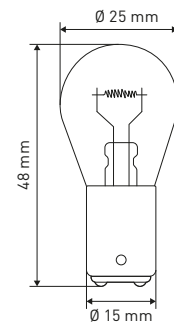



## BA15D

U1 (V)	P1 (W)	P2 (W)	REF
6	10	10	<a href="#">159TA9950</a>
6	35	35	<a href="#">103TA4619</a>

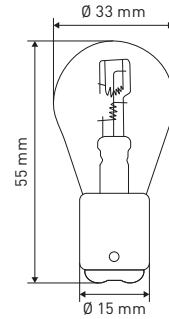

U1 (V)	P1 (W)	P2 (W)	REF
12	21	5	<a href="#">141TA9822</a>
24	21	2	<a href="#">142TA1225</a>

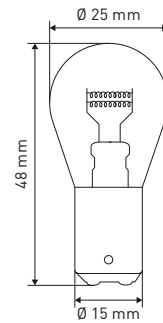

U1 (V)	P1 (W)	REF
24	5	<a href="#">122TA9130</a>
48	5	<a href="#">131TA4779</a>

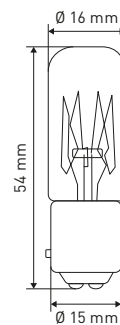





## BA15D

U1 (V)	P1 (W)	REF
24	35	<a href="#">131TA4783</a>
48	35	<a href="#">103TA4634</a>

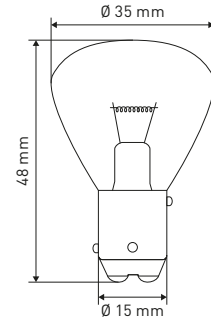

U1 (V)	P1 (W)	REF
12	36	<a href="#">141TA9874</a>
24	36	<a href="#">141TA9875</a>
24	48	<a href="#">141TA9877</a>

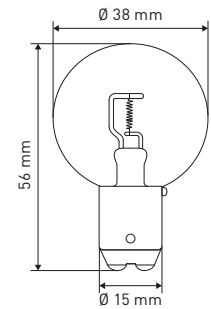

U1 (V)	P1 (W)	Remark	REF
24	40	White	<a href="#">131TA4780</a>
48	40	White	<a href="#">106TA4902</a>

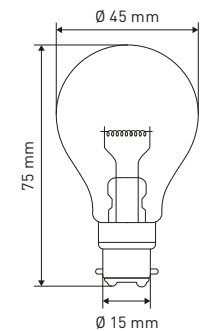



## BAY15D

U1 (V)	P1 (W)	REF
24	25	<a href="#">106TA4879</a>
36	25	<a href="#">106TA4881</a>
48	10	<a href="#">119TA8924</a>
48	25	<a href="#">123TA7992</a>
48	40	<a href="#">115TA4606</a>
56	25	<a href="#">106TA4882</a>

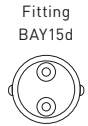
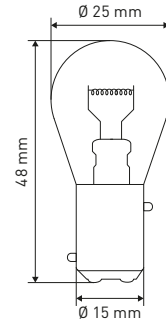

U1 (V)	P1 (W)	P2 (W)	Remark	REF
6	21	5		<a href="#">163TA8851</a>
12	18	5		<a href="#">141TA9840</a>
12	21	5		<a href="#">123TA7988</a>
12	21	5	Heavy-duty	<a href="#">142TA3653</a>
12	23	8		<a href="#">106TA4874</a>
24	21	5		<a href="#">123TA7989</a>
24	24	6		<a href="#">159TA9956</a>
24	25	10		<a href="#">103TA4623</a>
36	25	10		<a href="#">106TA4876</a>
48	25	10		<a href="#">123TA7990</a>
60	25	10		<a href="#">123TA7991</a>
80	10	5		<a href="#">119TA8923</a>

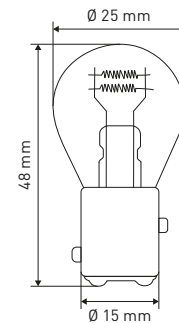

U1 (V)	P1 (W)	REF
12	40	<a href="#">163TA8852</a>
24	40	<a href="#">119TA8926</a>
36	40	<a href="#">111TA2799</a>
48	40	<a href="#">103TA4636</a>
56	40	<a href="#">103TA4637</a>
60	40	<a href="#">141TA9866</a>

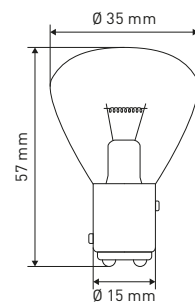



## BAY15D

U1 (V)	P1 (W)	P2 (W)	REF
12	40	30	<a href="#">106TA4885</a>
24	60	60	<a href="#">103TA4635</a>

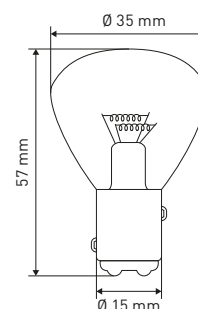

## BAU15S

U1 (V)	P1 (W)	Remark	REF
12	21	Orange	<a href="#">140TA8980</a>
24	21	Orange	<a href="#">140TA8979</a>

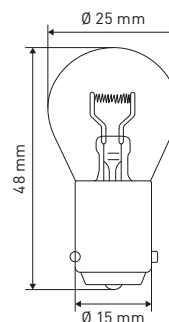

## BAZ15D

U1 (V)	P1 (W)	P2 (W)	REF
12	21	4	<a href="#">103TA4624</a>
24	21	4	<a href="#">141TA9849</a>

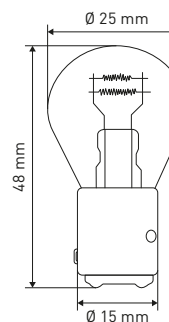



## BA20S

U1 (V)	P1 (W)	REF
6	35	<a href="#">103TA4657</a>
6	45	<a href="#">103TA4658</a>
12	35	<a href="#">123TA7998</a>
12	45	<a href="#">103TA4661</a>
12	50	<a href="#">103TA4660</a>
24	35	<a href="#">123TA7999</a>
24	45	<a href="#">103TA4663</a>
24	50	<a href="#">131TA4789</a>
36	35	<a href="#">103TA4664</a>
48	25	<a href="#">131TA4790</a>
48	35	<a href="#">123TA8000</a>
80	10	<a href="#">131TA4787</a>
80	35	<a href="#">123TA8001</a>

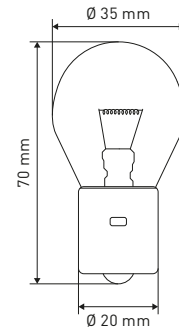

Fitting  
BA20s

## BA20D

U1 (V)	P1 (W)	P2 (W)	REF
6	15	15	<a href="#">122TA9132</a>
6	25	25	<a href="#">122TA9133</a>
6	35	35	<a href="#">122TA9134</a>
6	45	40	<a href="#">103TA4649</a>
12	35	35	<a href="#">123TA7997</a>
12	45	40	<a href="#">103TA4652</a>
24	35	35	<a href="#">131TA4786</a>
24	45	40	<a href="#">103TA4653</a>

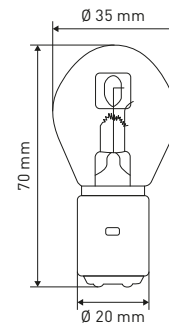

Fitting  
BA20d

U1 (V)	P1 (W)	REF
24	25	<a href="#">122TA9135</a>
48	25	<a href="#">131TA4793</a>
48	35	<a href="#">131TA4794</a>
80	25	<a href="#">103TA4669</a>
80	35	<a href="#">131TA4792</a>

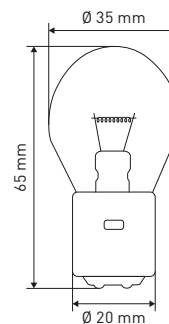

Fitting  
BA20d



## BA20D

U1 (V)	P1 (W)	REF
80	10	<a href="#">106TA4890</a>

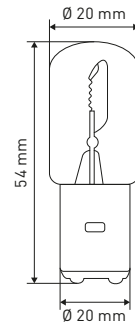

## BA21S

U1 (V)	P1 (W)	REF
12	45	<a href="#">106TA4894</a>

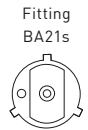
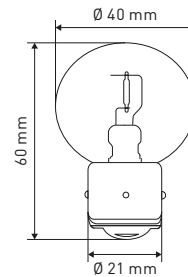

## BA21D

U1 (V)	P1 (W)	P2 (W)	REF
12	45	40	<a href="#">141TA9915</a>

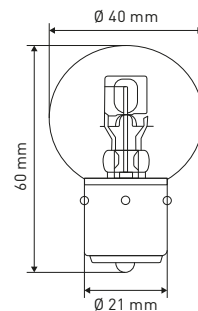



## P15S

U1 (V)	P1 (W)	REF
12	35	<a href="#">103TA4638</a>
24	40	<a href="#">106TA4899</a>

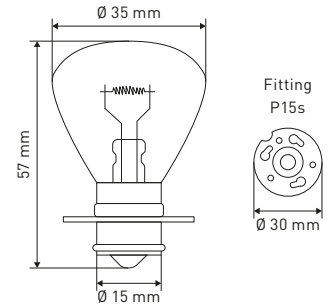

## P15D

U1 (V)	P1 (W)	REF
12	45	<a href="#">103TA4643</a>
24	35	<a href="#">103TA4644</a>
36	30	<a href="#">122TA9131</a>
48	25	<a href="#">123TA7995</a>
48	45	<a href="#">123TA7996</a>
48	50	<a href="#">106TA4900</a>

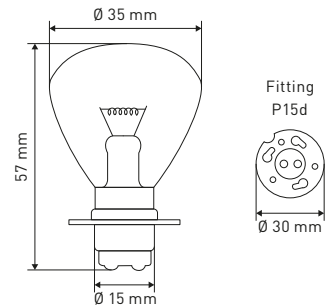

U1 (V)	P1 (W)	P2 (W)	REF
6	35	35	<a href="#">103TA4640</a>
12	35	35	<a href="#">142TA1295</a>
12	45	45	<a href="#">159TA9957</a>
24	35	35	<a href="#">131TA4785</a>
24	40	30	<a href="#">106TA4886</a>
24	62	62	<a href="#">106TA4887</a>

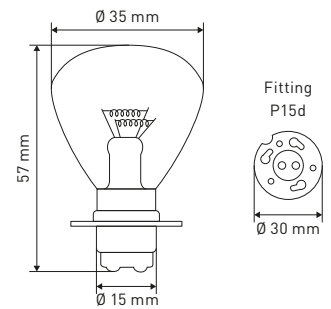



## P15D-3

U1 (V)	P1 (W)	P2 (W)	REF
12	35	35	<a href="#">119TA8927</a>

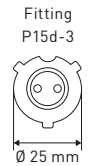
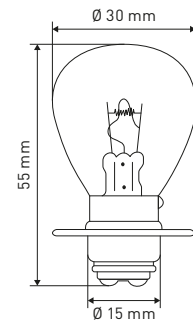

## P36S

U1 (V)	P1 (W)	REF
12	48	<a href="#">106TA4891</a>

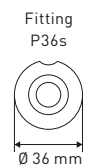
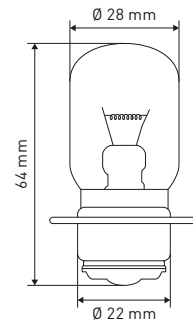

## P36D

U1 (V)	P1 (W)	REF
12	38	<a href="#">106TA4893</a>
24	44	<a href="#">122TA9137</a>

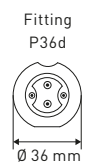
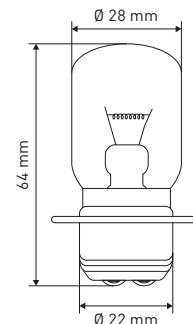



## P36D

U1 (V)	P1 (W)	P2 (W)	REF
12	50	40	<a href="#">122TA9136</a>
24	45	40	<a href="#">106TA4892</a>

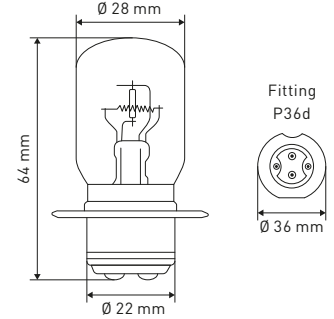

## R2

U1 (V)	P1 (W)	P2 (W)	REF
12	45	40	<a href="#">106TA4826</a>
24	55	50	<a href="#">106TA4827</a>

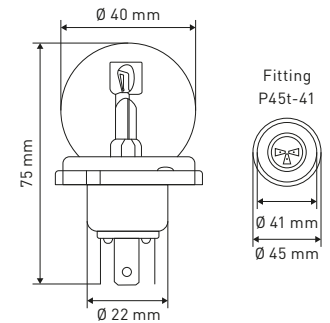

## R2

U1 (V)	P1 (W)	P2 (W)	Remark	REF
12	45	40	Yellow	<a href="#">106TA4828</a>
24	55	50	Yellow	<a href="#">103TA4532</a>

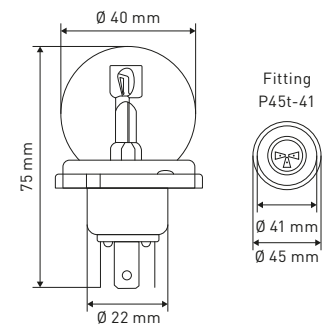





## E5

U1 (V)	P1 (W)	REF
24	1,2	<a href="#">142TA1169</a>

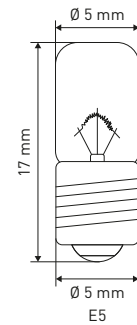

## E10

U1 (V)	P1 (W)	REF
12	1,2	<a href="#">106TA4905</a>
24	1	<a href="#">122TA9138</a>
24	1,2	<a href="#">106TA4836</a>
24	2	<a href="#">103TA4544</a>
24	2,4	<a href="#">142TA1293</a>
24	2,8	<a href="#">142TA1232</a>
24	3	<a href="#">131TA4797</a>
30	2	<a href="#">123TA8003</a>
48	2	<a href="#">131TA4798</a>
48	3	<a href="#">122TA9139</a>
55	2	<a href="#">103TA4546</a>
60	3	<a href="#">123TA8004</a>
80	2	<a href="#">122TA9140</a>
80	3,2	<a href="#">119TA8928</a>

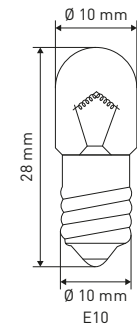



## E10

U1 (V)	P1 (W)	REF
12	2,2	<a href="#">122TA9141</a>
12	3	<a href="#">106TA4838</a>
24	3	<a href="#">115TA4608</a>
48	3	<a href="#">142TA1174</a>

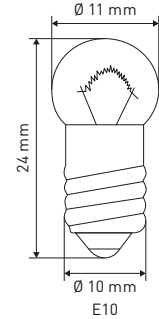

U1 (V)	P1 (W)	REF
12	4	<a href="#">103TA4547</a>
24	5	<a href="#">106TA4835</a>

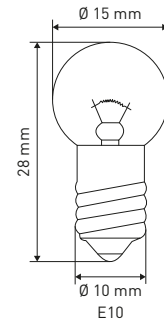

## E14

U1 (V)	P1 (W)	REF
12	1,2	<a href="#">103TA4548</a>
12	2	<a href="#">119TA8929</a>
12	3	<a href="#">122TA9142</a>
24	2	<a href="#">122TA9143</a>

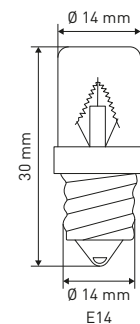



## E14

U1 (V)	P1 (W)	REF
12	15	<a href="#">142TA1258</a>
24	5	<a href="#">142TA1173</a>

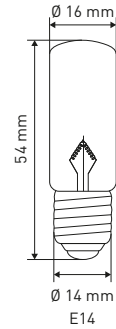

## E27

U1 (V)	P1 (W)	Colour temperature (K)	REF
24	40	2700	<a href="#">142TA1373</a>
24	60	2700	<a href="#">144TA5705</a>

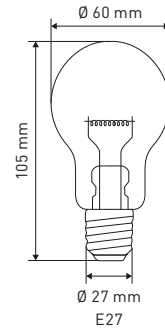

## SV7-8

U1 (V)	P1 (W)	REF
12	3	<a href="#">103TA4533</a>
12	5	<a href="#">103TA4534</a>
24	3	<a href="#">103TA4535</a>
24	5	<a href="#">103TA4536</a>
48	3	<a href="#">122TA9147</a>
48	5	<a href="#">122TA9148</a>

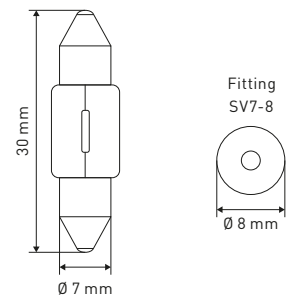



## SV8.5-8

U1 (V)	P1 (W)	REF
12	5	<a href="#">103TA4537</a>
12	10	<a href="#">103TA4538</a>
24	5	<a href="#">103TA4539</a>
24	10	<a href="#">106TA4829</a>
48	5	<a href="#">119TA8936</a>

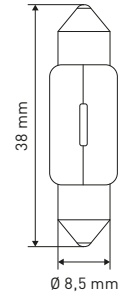

U1 (V)	P1 (W)	REF
6	10	<a href="#">106TA4834</a>
12	5	<a href="#">106TA4830</a>
12	10	<a href="#">106TA4831</a>
24	5	<a href="#">103TA4540</a>
24	10	<a href="#">106TA4907</a>
48	5	<a href="#">119TA8937</a>

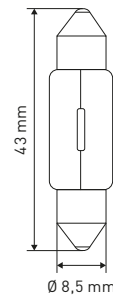

U1 (V)	P1 (W)	REF
12	10	<a href="#">131TA4804</a>
12	15	<a href="#">106TA4832</a>
12	18	<a href="#">103TA4541</a>
12	21	<a href="#">106TA4896</a>
24	10	<a href="#">131TA4805</a>
24	15	<a href="#">122TA9149</a>
24	18	<a href="#">106TA4833</a>
24	21	<a href="#">119TA8938</a>
48	10	<a href="#">122TA9150</a>

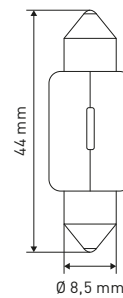



## W2X4.6D

U1 (V)	P1 (W)	REF
12	1	<a href="#">103TA4550</a>
12	1,2	<a href="#">123TA8014</a>
12	2	<a href="#">103TA4551</a>
14	1,4	<a href="#">142TA1104</a>
24	1	<a href="#">122TA9151</a>
24	1,2	<a href="#">103TA4553</a>
24	2	<a href="#">122TA9152</a>

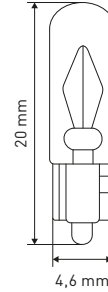

Fitting  
W2x4.6d

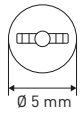

U1 (V)	P1 (W)	REF
12	3	<a href="#">159TA9958</a>
14	3	<a href="#">103TA4552</a>

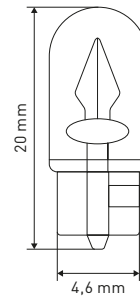

Fitting  
W2x4.6d

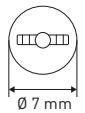

## W2.1X9.5D

U1 (V)	P1 (W)	Remark	REF
12	2		<a href="#">123TA8035</a>
12	3		<a href="#">103TA4554</a>
12	3,4		<a href="#">142TA1238</a>
12	5	Orange	<a href="#">159TA9959</a>
12	5		<a href="#">103TA4555</a>
12	6		<a href="#">142TA1231</a>
14	3,8		<a href="#">142TA1131</a>
24	3		<a href="#">103TA4556</a>
24	5		<a href="#">103TA4557</a>
48	2		<a href="#">142TA1284</a>

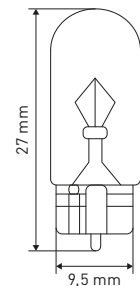

Fitting  
W2.1x9.5d

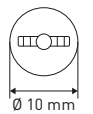



## W2.1X9.5D

U1 (V)	P1 (W)	REF
12	10	<a href="#">142TA1296</a>
12	15	<a href="#">142TA1333</a>

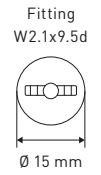
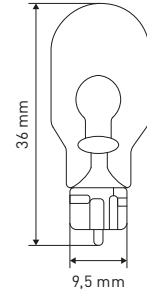

## W2.5X16Q

U1 (V)	P1 (W)	P2 (W)	Remark	REF
12	27	7		<a href="#">142TA1260</a>
12	27	7	Orange	<a href="#">159TA9960</a>

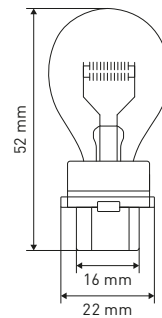

## W3X16D

U1 (V)	P1 (W)	Remark	REF
12	21		<a href="#">161TA5788</a>
12	21	Orange	<a href="#">161TA5789</a>

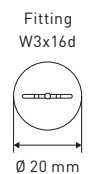
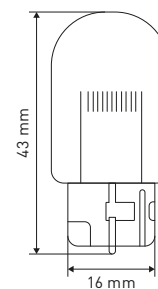



## W3X16Q

U1 (V)	P1 (W)	P2 (W)	REF
12	21	5	<a href="#">161TA5790</a>

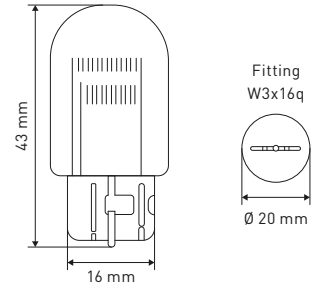

## RIGID LOOP

U1 (V)	P1 (W)	REF
12	10	<a href="#">103TA4558</a>

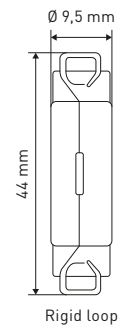

## T5.5K

U1 (V)	P1 (W)	REF
12	1,2	<a href="#">131TA4806</a>
24	1,2	<a href="#">131TA4807</a>
30	1,2	<a href="#">159TA9963</a>
48	1,2	<a href="#">122TA9153</a>
60	1,2	<a href="#">159TA9964</a>

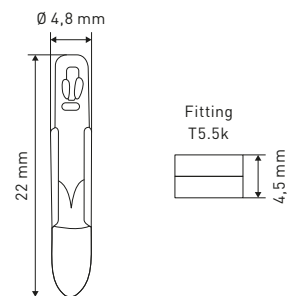



## T5.5

U1 (V)	P1 (W)	REF
12	1,2	<a href="#">159TA9966</a>
24	1,2	<a href="#">142TA1282</a>
36	1,2	<a href="#">159TA9965</a>
48	1,2	<a href="#">122TA9166</a>
48	1,44	<a href="#">122TA9167</a>
60	1,2	<a href="#">142TA1299</a>

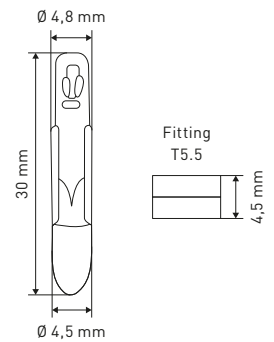

## PSB

U1 (V)	P1 (W)	REF
48	2,54	<a href="#">126TA5928</a>

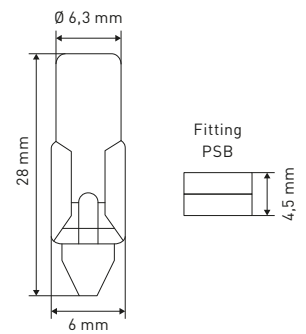



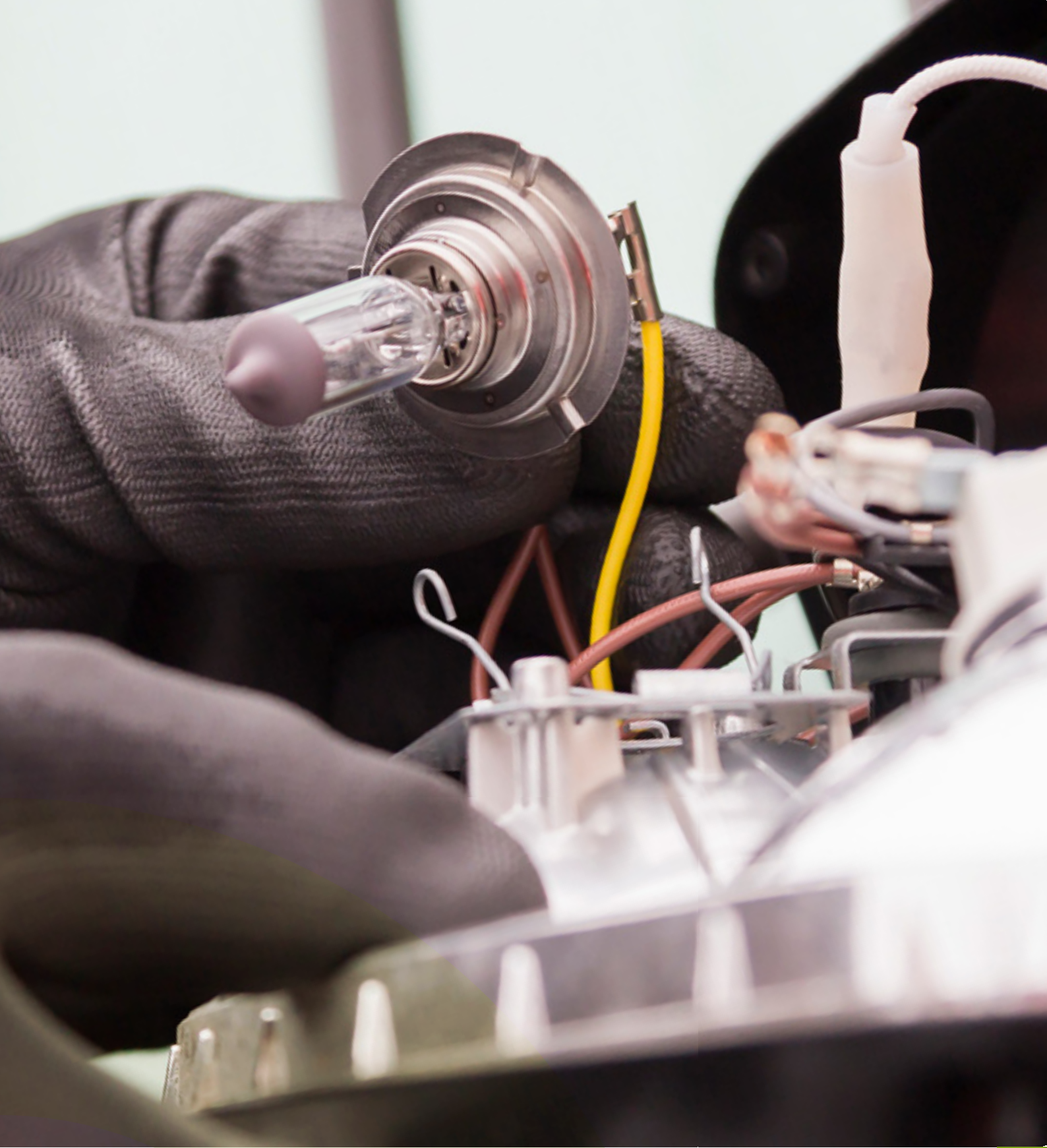

# HALOGEN BULBS



## NICE TO KNOW – HALOGEN BULBS



### Advantages:

- Longer lifespan, up to five times longer than conventional incandescent bulbs
- Bulb can be more accurately directed
- Better luminous efficacy
- Yield up to 25 lumen per watt
- Complete clarity immediately after start-up
- Available with or without reflector
- More compact thanks to the halogen cycle
- The same pleasant colour temperatures as incandescent bulbs

A halogen bulb is basically an incandescent bulb of which the bulb is filled with an inert gas under high pressure. A small amount of halogen is added to the gas (bromine or iodine). Hence the name halogen bulb.

Because of the high temperature, the tungsten sublimates partially and condensates on the much colder glass. Small amounts of iodine and bromine convert the tungsten – mainly what is situated on the glass – into tungsten (III), iodide (WI3), tungsten (IV), chloride (WCl4). As a result of the much higher temperature of the filament itself, the balance shifts to the side of the reagents, so that the tungsten is deposited on the filament, slightly reversing the sublimation losses. Since the highest temperatures occur on the places where the filament is thinnest, the material precipitates where the need is highest, which prevents the filaments from burning out.

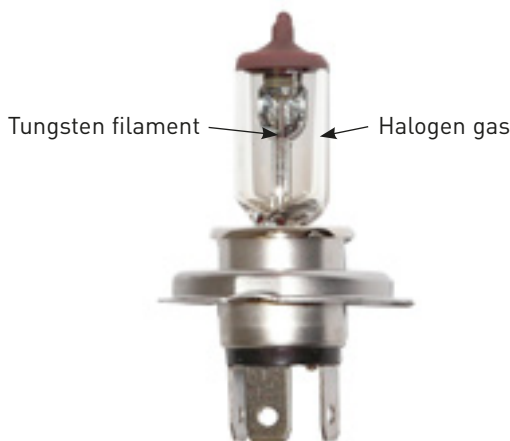

**Halogen bulbs reach much higher temperatures than incandescent light bulbs. Touching them with the fingers can cause organic material (greasy fingerprints) to remain on the bulb, resulting in brown spots due to carbonisation after burning.**

**This dark residue will then result in a higher heating of the bulb end, a significant shortening of the lifespan of the bulb.**



## BA9S

U1 (V)	P1 (W)	REF
12	5	<a href="#">141TA9742</a>
12	20	<a href="#">141TA9760</a>

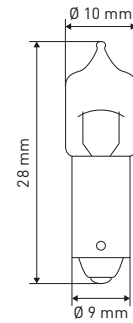

## BAY9S

U1 (V)	P1 (W)	REF
12	21	<a href="#">160TA1078</a>
24	21	<a href="#">160TA1077</a>

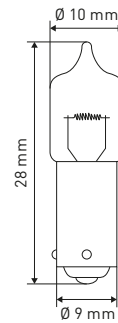

## BA15D

U1 (V)	P1 (W)	REF
12	10	<a href="#">141TA9819</a>
12	20	<a href="#">141TA9820</a>

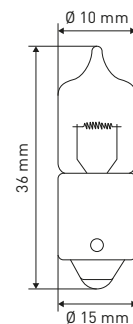



## H1

U1 (V)	P1 (W)	Remark	REF
6	55		<a href="#"><u>160TA1079</u></a>
12	55		<a href="#"><u>123TA8005</u></a>
12	55	Heavy-duty	<a href="#"><u>142TA1281</u></a>
12	100		<a href="#"><u>103TA4521</u></a>
24	55		<a href="#"><u>119TA8930</u></a>
24	70		<a href="#"><u>123TA8006</u></a>
24	70	Heavy-duty	<a href="#"><u>142TA1259</u></a>

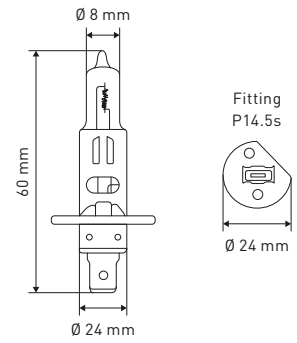

## H2

U1 (V)	P1 (W)	REF
12	55	<a href="#"><u>103TA4522</u></a>
24	70	<a href="#"><u>103TA4523</u></a>

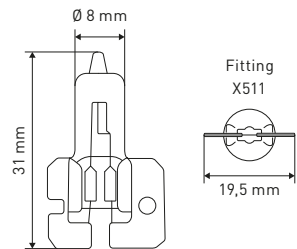



## H3

U1 (V)	P1 (W)	Remark	REF
6	25		<a href="#">119TA8931</a>
6	55		<a href="#">119TA8932</a>
12	35		<a href="#">141TA9695</a>
12	55		<a href="#">123TA8007</a>
12	55	Heavy-duty	<a href="#">142TA1110</a>
12	100		<a href="#">103TA4527</a>
15	50		<a href="#">142TA1208</a>
24	35		<a href="#">131TA4799</a>
24	55		<a href="#">119TA8933</a>
24	70		<a href="#">123TA8008</a>
24	70	Heavy-duty	<a href="#">142TA1244</a>
24	100		<a href="#">142TA1292</a>
36	45		<a href="#">123TA8009</a>
48	35		<a href="#">131TA4801</a>
48	45		<a href="#">123TA8010</a>
48	60		<a href="#">123TA8011</a>
80	55		<a href="#">103TA4675</a>

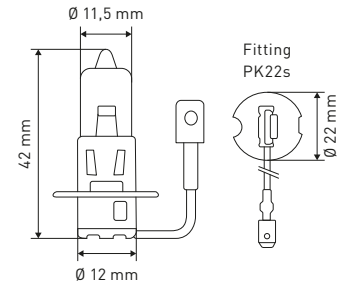

## H4

U1 (V)	P1 (W)	P2 (W)	REF
12	45	40	<a href="#">163TA8853</a>
12	60	55	<a href="#">123TA8012</a>
12	100	55	<a href="#">103TA4528</a>
12	100	80	<a href="#">119TA8935</a>
12	100	90	<a href="#">103TA4529</a>
24	75	70	<a href="#">123TA8013</a>
24	100	70	<a href="#">160TA1081</a>
24	100	90	<a href="#">160TA1082</a>

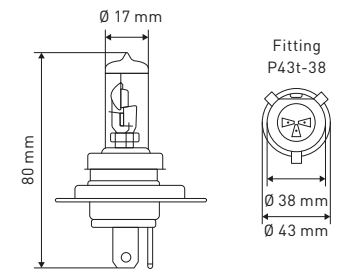

U1 (V)	P1 (W)	P2 (W)	REF
12	45	40	<a href="#">160TA1083</a>
12	60	55	<a href="#">106TA4825</a>
12	100	80	<a href="#">103TA4531</a>
24	75	70	<a href="#">131TA4802</a>

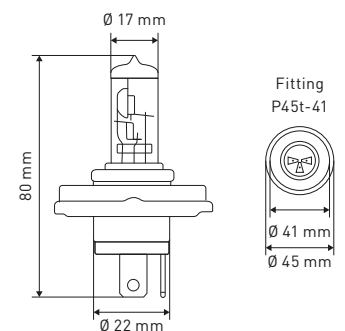



## H4

U1 (V)	P1 (W)	P2 (W)	Remark	REF
12	60	55	Yellow	<a href="#">106TA4823</a>
24	75	70	Yellow	<a href="#">142TA1159</a>

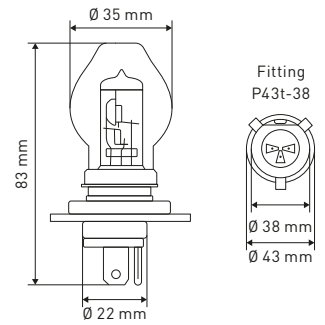

## H7

U1 (V)	P1 (W)	REF
12	55	<a href="#">106TA4908</a>
12	100	<a href="#">160TA1085</a>
24	70	<a href="#">106TA4909</a>

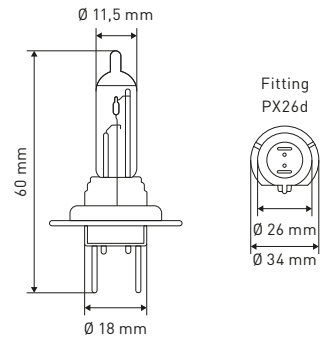

## H8

U1 (V)	P1 (W)	REF
12	35	<a href="#">161TA5887</a>

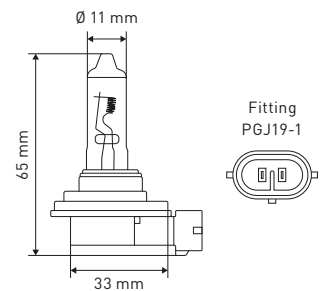

## H9

U1 (V)	P1 (W)	REF
12	65	<a href="#">161TA5888</a>

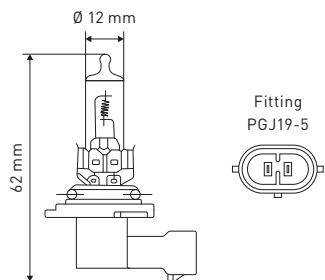



## H10 (9145)

U1 (V)	P1 (W)	REF
12	45	<a href="#">161TA5889</a>

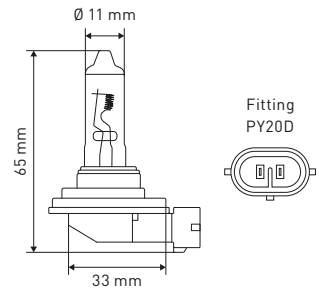

## H11

U1 (V)	P1 (W)	REF
12	55	<a href="#">161TA5890</a>
24	70	<a href="#">161TA5891</a>

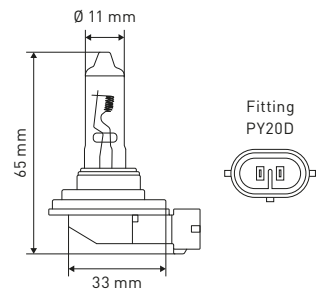

## H13 (9008)

U1 (V)	P1 (W)	P2 (W)	REF
12	60	55	<a href="#">161TA5892</a>

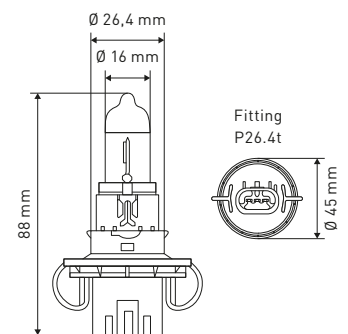

## H16

U1 (V)	P1 (W)	REF
12	19	<a href="#">161TA5893</a>

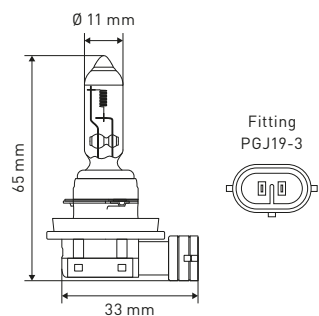



## HB1 (9004)

U1 (V)	P1 (W)	P2 (W)	REF
12	65	45	<a href="#">161TA5894</a>

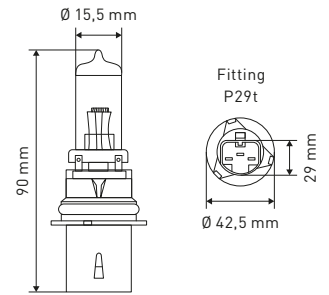

## HB3 (9005)

U1 (V)	P1 (W)	REF
12	60	<a href="#">161TA5895</a>

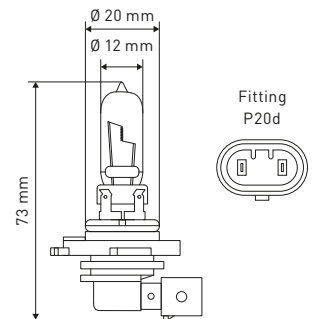

## HB4 (9006)

U1 (V)	P1 (W)	REF
12	55	<a href="#">142TA1302</a>

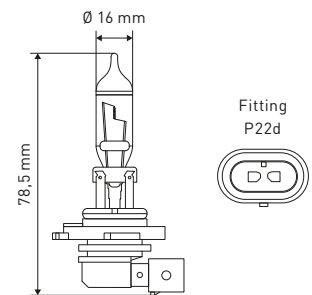

## HB5 (9007)

U1 (V)	P1 (W)	P2 (W)	REF
12	65	55	<a href="#">161TA5897</a>

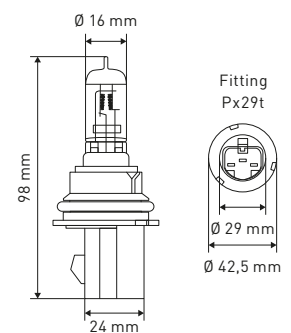





## PG13

U1 (V)	P1 (W)	REF
12	27	<a href="#">161TA5898</a>
12	50	<a href="#">161TA5899</a>

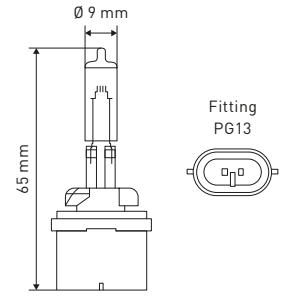

## PGJ13

U1 (V)	P1 (W)	REF
12	27	<a href="#">122TA9144</a>
12	37,5	<a href="#">122TA9145</a>
12	50	<a href="#">122TA9146</a>

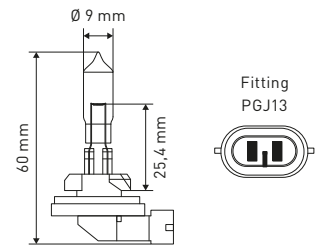

## G4

U1 (V)	P1 (W)	Colour temperature (K)	REF
12	20	2800	<a href="#">142TA1316</a>
24	20	2800	<a href="#">142TA1214</a>

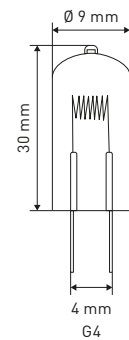

## R7S

U1 (V)	P1 (W)	L1 (mm)	Colour temperature (K)	REF
230	240	117	4900	<a href="#">160TA1087</a>
230	400	118	8700	<a href="#">142TA1350</a>
230	1000	190	22 000	<a href="#">142TA1362</a>
230	2000	553	44 000	<a href="#">142TA1368</a>

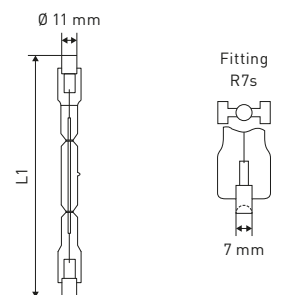



NOTES

A series of horizontal dotted lines for writing notes.



# FLUORESCENT BULBS



## NICE TO KNOW – FLUORESCENT BULBS



A fluorescent bulb produces light when a fluorescent layer inside the bulb is hit by ultraviolet radiation, generated during the gas discharge inside the bulb. The most common example of this are the well-known fluorescent tubes and low-energy light bulbs. The light output in lumen per watt is 5 to 6 times greater than an incandescent bulb.

**Principle:**

The inside of a tube is covered in a fluorescent layer and filled with a noble gas (argon, krypton or a mixture of both) and mercury vapour under low pressure. An electric discharge takes place between the two electrodes on each side of the tube, causing the mercury vapour to radiate ultraviolet light. The fluorescent layer then converts the ultraviolet light into visible light.

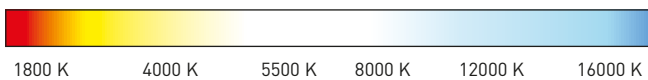

**Advantages:**

High energy-efficiency and light streams

**Disadvantages:**

Large dimensions

Old colour code	New colour code	Colour
29	530	Warm white
35	535	Neutral white
33	640	Cool white
25	740	Standard white
54	765	Cool daylight
	827	Extra warm white
	830	Warm white
	835	Neutral white
	840	Cool white
	865	Cool daylight
	930	Warm white
	940	Cool white
	950	Daylight
	965	Cool daylight
	15	Red
	16	Yellow
	17	Green
	18	Blue



## E27

U1 (V)	P1 (W)	Colour temperature (K)	REF
230	8	2700	<a href="#">142TA1357</a>

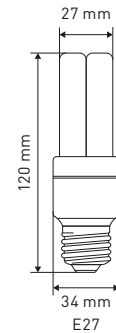

## G5

P1 (W)	L1 (mm)	Colour temperature (K)	REF
6	212	3000	<a href="#">142TA1345</a>
8	288	3000	<a href="#">142TA1356</a>
8	288	4000	<a href="#">136TA3029</a>
13	515	4000	<a href="#">142TA1343</a>

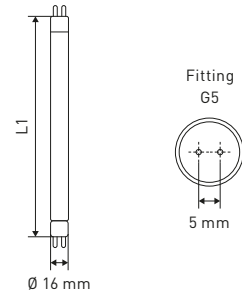

## 2G7

P1 (W)	L1 (mm)	Colour temperature (K)	REF
7	114	4000	<a href="#">142TA1347</a>
11	214	4000	<a href="#">142TA1344</a>

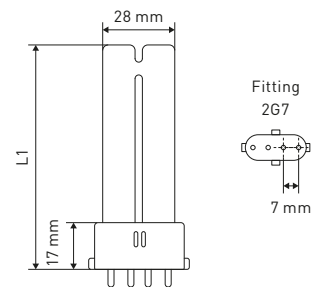

## 2G11

P1 (W)	L1 (mm)	Colour temperature (K)	REF
18	220	2700	<a href="#">142TA1363</a>
36	411	4000	<a href="#">142TA1103</a>

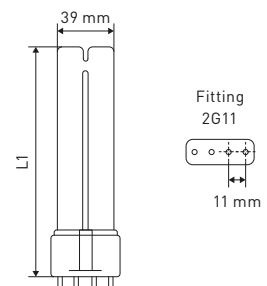



## G23

P1 (W)	L1 (mm)	Colour temperature (K)	REF
11	235	4000	<a href="#">142TA1335</a>

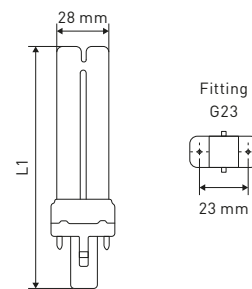



# HIGH INTENSITY DISCHARGE BULBS



## NICE TO KNOW – HIGH INTENSITY DISCHARGE BULBS



D1S + D3S



D2S + D4S

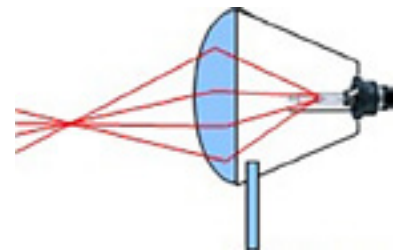

D1R + D3R



D2R + D4R

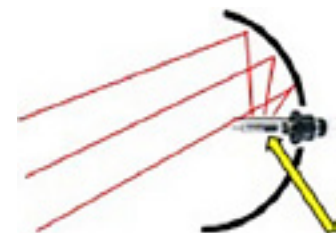

A xenon arc bulb is a gas discharge bulb in which a light arc is generated within xenon gas under high pressure. This creates a nearly point-shaped light source with a high luminance.

A gas discharge bulb is an artificial light source that produces light by sending an electric current through ionised gas. Xenon is the gas used for this bulb.

### Tips:

- If you have installed the bulb correctly and it doesn't light up, then the ballast is faulty and not the bulb.
- Don't touch the bulb with your bare hands.
- When changing one bulb, also replace the other one to prevent colour differences.

### Advantages:

- Generates up to 3 times the amount of light
- Longer and wider light image
- Up to 7 times the life span
- Lower power consumption
- Xenon bulbs use 35 W, which is less than a H4 (60 W) and H7 (55 W)





## D1S

U1 (V)	P1 (W)	REF
85	35	<a href="#">144TA5693</a>

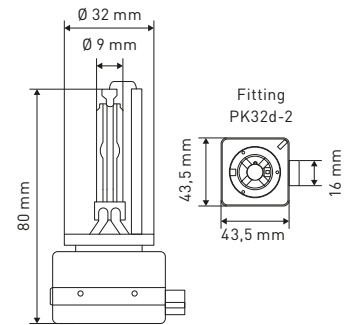
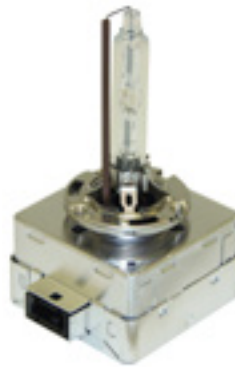

## D1R

U1 (V)	P1 (W)	REF
85	35	<a href="#">147TA4298</a>

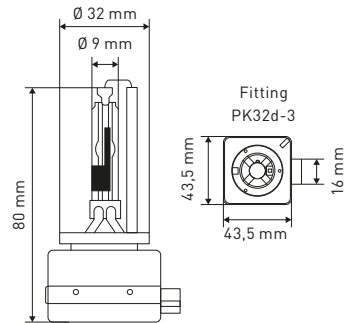

## D2S

U1 (V)	P1 (W)	REF
85	35	<a href="#">142TA1265</a>

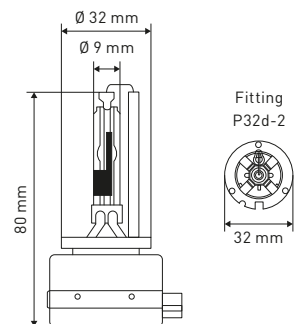

## D2R

U1 (V)	P1 (W)	REF
85	35	<a href="#">161TA5904</a>

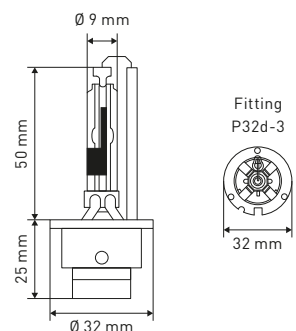



## MVR 1000/BT 37

- Peak lead ballast: 750V
- RMS lag ballast: 530V

P1 (W)	Colour temperature (K)	REF
1000	4000	<a href="#"><u>161TA5955</u></a>

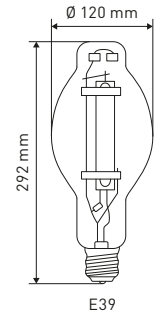

## MVR 1000/BT 56

- Peak lead ballast: 750V
- RMS lag ballast: 530V

P1 (W)	Colour temperature (K)	REF
1000	4000	<a href="#"><u>142TA1084</u></a>

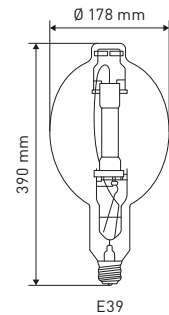



# SPARE KITS/ DASHBOARD BULBS



## NICE TO KNOW – SPARE KITS/DASHBOARD BULBS



Are you hitting the road soon? Make sure you are properly and correctly equipped. You will find what you need in this overview.

### Advantages:

- Robust packaging
- High quality
- Different types
- Multiple by species

1. First aid kit  
**REF 140TA8638**

2. Safety jackets  
**REF 141TA7655** – S/M  
**REF 141TA7656** – L/XL  
**REF 141TA7657** – XXL/XXXL

3. Emergency triangle  
**REF 107TA8060**

4. Fire extinguisher  
**REF 107TA8110** – 1 kg



Country	Spare bulbs	First-aid kit	High-visibility safety vest	Emergency triangle	Fire extinguisher
Austria	R	M	M	M	R
Belgium	R	M	M	M	M
Bulgaria	M	M	M	M	M
Croatia	M	M	M	M	M*
Czech Republic	R	M	M	M	N
Denmark	R	R	R	M	R
Estonia	R	M	M	M	M
Finland	R	R	R	M	R
France	R	R	M	M	R
Germany	R	M	M	M	R
Hungary	N	M	M	M	N
Italy	R	R	M	M	R
Latvia	R	M	R	M	M
Lithuania	R	M	M	M	M
Luxembourg	R	R	M	M	R
Norway	R	R	M	M	R**
Poland	M	N	N	M	M
Sweden	N	N	R	M	N**
Switzerland	N	N	N	M	N
The Netherlands	R	R	R	M	R

M = mandatory · R = recommended · N = no actual legislation  
M\* only at commercial vehicles  
\*\* coaches only



## B8.3D

U1 (V)	P1 (W)	Remark	REF
12	1,2	Black	<a href="#">142TA1331</a>
12	2	Blue	<a href="#">160TA1100</a>
24	1,2	Grey	<a href="#">160TA1109</a>

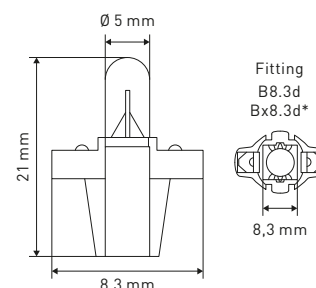

## B8.4D

U1 (V)	P1 (W)	Remark	REF
12	1,1	Orange	<a href="#">160TA1095</a>
12	1,2	Black	<a href="#">160TA1096</a>
12	1,2	Blue	<a href="#">160TA1097</a>
12	1,3	Olive green	<a href="#">160TA1117</a>
12	1,5	Beige	<a href="#">160TA1098</a>
12	1,8	Beige	<a href="#">160TA1118</a>
12	2	Light green	<a href="#">160TA1099</a>
24	1,2	Brown	<a href="#">142TA1349</a>

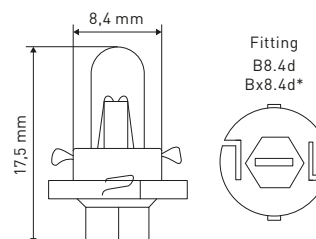

## B8.5D

U1 (V)	P1 (W)	Remark	REF
12	0,4	Lila	<a href="#">160TA1093</a>
12	1	Orange	<a href="#">160TA1092</a>
12	1,12	White	<a href="#">160TA1119</a>
12	1,2	Blue	<a href="#">160TA1091</a>
12	1,2	Black	<a href="#">122TA9154</a>
12	1,5	Beige	<a href="#">160TA1094</a>
12	2	Green	<a href="#">122TA9155</a>
12	2	Light green	<a href="#">160TA1116</a>
24	1,2	Grey	<a href="#">122TA9156</a>
24	1,2	Brown	<a href="#">160TA1108</a>

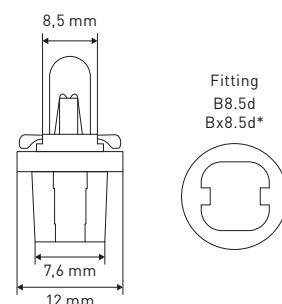



## B8.7D

U1 (V)	P1 (W)	Remark	REF
12	1,2	Grey	<a href="#">161TA5915</a>
12	2	Green	<a href="#">142TA1321</a>
24	1,2	Brown	<a href="#">160TA1110</a>

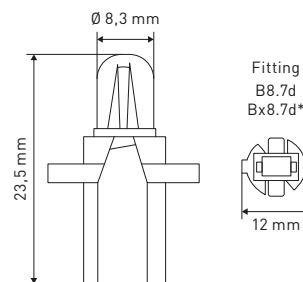

## B10D

U1 (V)	P1 (W)	Remark	REF
12	3	Brown	<a href="#">160TA1104</a>
12	5	Black	<a href="#">160TA1105</a>

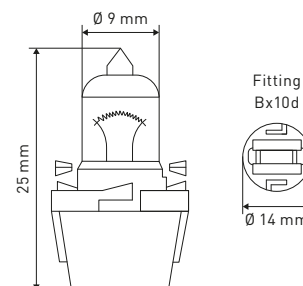

## MFHZ

U1 (V)	P1 (W)	Remark	REF
12	1,2	Black	<a href="#">160TA1101</a>

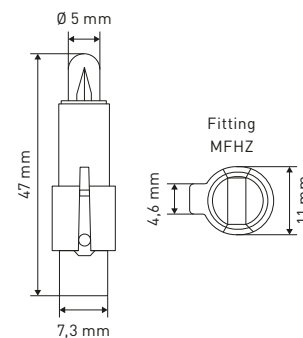

## MFJF

U1 (V)	P1 (W)	Remark	REF
12	1,2	Black	<a href="#">160TA1102</a>

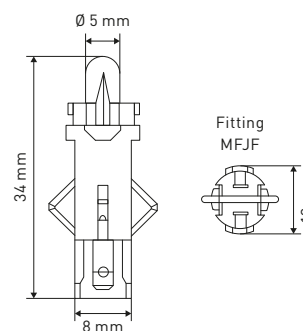



## MFSL

U1 (V)	P1 (W)	Remark	REF
12	1,2	Black	<a href="#">160TA1103</a>

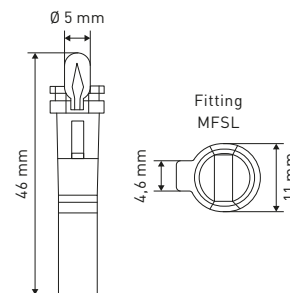

## EBSR

U1 (V)	P1 (W)	Remark	REF
12	1,2	Brown	<a href="#">160TA1112</a>
24	1,2	Yellow	<a href="#">160TA1113</a>
24	1,4	Light green	<a href="#">160TA1114</a>

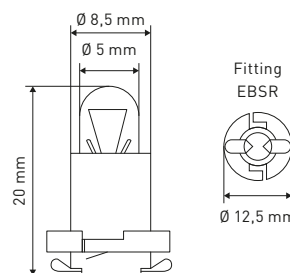

## T5

U1 (V)	P1 (W)	Remark	REF
12	1,2	Brown	<a href="#">142TA1201</a>
12	2	Black	<a href="#">142TA1252</a>
14	2	Black	<a href="#">142TA1082</a>
14	1,4	Black	<a href="#">161TA5906</a>
14	1,4	Green	<a href="#">161TA5907</a>
24	1,2	Grey	<a href="#">161TA5908</a>
24	1,4	Brown	<a href="#">161TA5909</a>
24	1,4	Grey	<a href="#">142TA1241</a>
24	1,8	Red	<a href="#">142TA1233</a>
24	2	Brown	<a href="#">161TA5910</a>

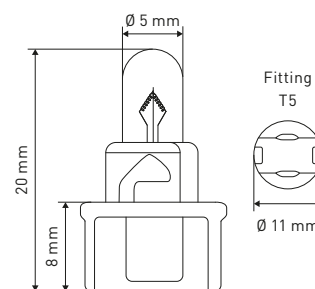



## T6.5

U1 (V)	P1 (W)	Remark	REF
14	3	Grey	<a href="#">144TA5650</a>
14	3	Black	<a href="#">142TA1317</a>
14	3	Red	<a href="#">142TA1094</a>
14	3	Blue	<a href="#">161TA5911</a>
24	3	Grey	<a href="#">142TA1090</a>

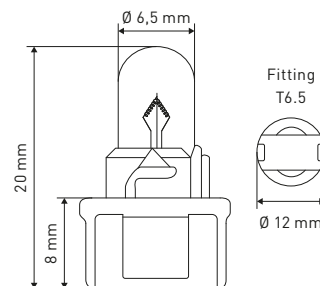

## T10

U1 (V)	P1 (W)	Remark	REF
12	3	Black	<a href="#">142TA1243</a>
12	5	Black	<a href="#">142TA1287</a>
24	3	Black	<a href="#">142TA1235</a>
24	3	Brown	<a href="#">142TA1294</a>

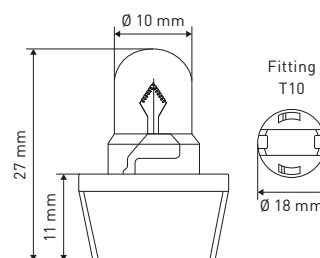

## T10 YAZAKI

U1 (V)	P1 (W)	Remark	REF
12	3	Black	<a href="#">142TA1237</a>
14	3,4	Green	<a href="#">161TA5912</a>
14	3,8	Green	<a href="#">161TA5913</a>

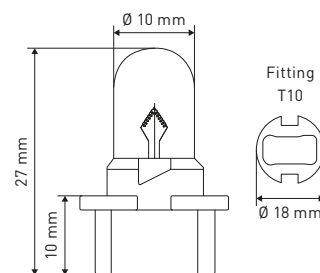

## KW2X4.6D

U1 (V)	P1 (W)	Remark	REF
12	1,2	White	<a href="#">159TA9962</a>
24	1	White	<a href="#">160TA1111</a>
24	1,2	White	<a href="#">159TA9961</a>
48	1,2	Beige	<a href="#">103TA4559</a>
48	1,2	Black	<a href="#">161TA5914</a>

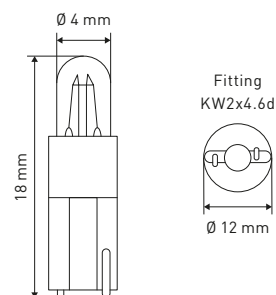





## DASHBOARD KIT 12V

U1 (V)	P1 (W)	Remark	ECE fitting	Quantity box	REF
12	0,4	Lila	B8,5D	5	<a href="#">160TA1093</a>
12	1	Orange	B8,5D	5	<a href="#">160TA1092</a>
12	1,1	Orange	B8,4D	5	<a href="#">160TA1095</a>
12	1,2	Black	B8,3D	5	<a href="#">142TA1331</a>
12	1,2	Black	B8,4D	5	<a href="#">160TA1096</a>
12	1,2	Blue	B8,4D	5	<a href="#">160TA1097</a>
12	1,2	Blue	B8,5D	5	<a href="#">160TA1091</a>
12	1,2	Black	B8,5D	5	<a href="#">122TA9154</a>
12	1,2	Black	MFHZ	5	<a href="#">160TA1101</a>
12	1,2	Black	MFJF	5	<a href="#">160TA1102</a>
12	1,2	Black	MFSL	5	<a href="#">160TA1103</a>
12	1,5	Beige	B8,5D	5	<a href="#">160TA1094</a>
12	1,5	Beige	B8,4D	5	<a href="#">160TA1098</a>
12	2	Blue	B8,3D	5	<a href="#">160TA1100</a>
12	2	Light green	B8,4D	5	<a href="#">160TA1099</a>
12	2	Green	B8,5D	5	<a href="#">122TA9155</a>
12	3	Brown	B10D	5	<a href="#">160TA1104</a>
12	5	Black	B8,5D	5	<a href="#">160TA1105</a>



REF [160TA1089](#) – Complete box

**TOTAL SOURCE**<sup>®</sup>

## DASHBOARD KIT 24V

U1 (V)	P1 (W)	Remark	ECE fitting	Quantity box	REF
24	1	White	Kw2x4,6D	5	<a href="#">160TA1111</a>
24	1,2	Clear	W2x4,6D	5	<a href="#">103TA4553</a>
24	1,2	Grey	B8,3D	5	<a href="#">160TA1109</a>
24	1,2	White	B8,4D	5	<a href="#">142TA1349</a>
24	1,2	Grey	B8,5D	5	<a href="#">122TA9156</a>
24	1,2	Brown	B8,5D	5	<a href="#">160TA1108</a>
24	1,2	Brown	B8,7D	5	<a href="#">160TA1110</a>
24	1,2	Yellow	EBS R4	5	<a href="#">160TA1113</a>
24	1,2	Brown	EBS R11	5	<a href="#">160TA1112</a>
24	1,4	Green	EBS R11	5	<a href="#">160TA1114</a>
24	3	Clear	W2,1x9,5D	5	<a href="#">103TA4556</a>
24	5	Clear	W2,1x9,5D	5	<a href="#">103TA4557</a>



REF [160TA1106](#) – Complete box

**TOTAL SOURCE**<sup>®</sup>



## DASHBOARD BULB KIT 12V

U1 (V)	P1 (W)	Remark	ECE fitting	Quantity box	REF
12	2	Blue	B8,7D	10	<a href="#">160TA1100</a>
12	1,1	Orange	B8,4D	10	<a href="#">160TA1095</a>
12	1,12	White	B8,5D	10	<a href="#">160TA1119</a>
12	1,2	Black	B8,3D	10	<a href="#">142TA1331</a>
12	1,2	Black	B8,5D	10	<a href="#">122TA9154</a>
12	1,2	Blue	B8,5D	10	<a href="#">160TA1091</a>
12	1,2	Blue	B8,4D	10	<a href="#">160TA1097</a>
12	1,2	Black	B8,4D	10	<a href="#">160TA1096</a>
12	1,3	Olive green	B8,4D	10	<a href="#">160TA1117</a>
12	1,5	Beige	B8,4D	10	<a href="#">160TA1098</a>
12	1,8	Beige	B8,4D	10	<a href="#">160TA1118</a>
12	2	Light green	B8,4D	10	<a href="#">160TA1099</a>
12	2	Green	B8,5D	10	<a href="#">122TA9155</a>
12	2	Light green	B8,5D	10	<a href="#">160TA1116</a>
12	3	Brown	B10D	10	<a href="#">160TA1104</a>
12	5	Black	B10D	10	<a href="#">160TA1105</a>
		Mounting tool			



REF [160TA1115](#) – Complete box

**PHILIPS**

## KIT H1 – 12V

U1 (V)	P1 (W)	P2 (W)	Remark	ECE fitting	Quantity box	REF
12	4			T4W	1	<a href="#">145TA2682</a>
12	5			R5W	1	<a href="#">145TA2680</a>
12	5			C5W	1	<a href="#">160TA1122</a>
12	21			P21W	1	<a href="#">145TA2673</a>
12	21	5		P21/5W	1	<a href="#">145TA2099</a>
12	55			H1	1	<a href="#">145TA2684</a>
			Fuse 15A		1	<a href="#">106TA4955</a>
			Fuse 20A		1	<a href="#">106TA4956</a>
			Fuse 30A		1	<a href="#">103TA2770</a>



REF [160TA1127](#) – Complete box

**PHILIPS**



## KIT H4 – 12V

U1 (V)	P1 (W)	P2 (W)	Remark	ECE fitting	Quantity box	REF
12	4			T4W	1	<a href="#">145TA2682</a>
12	5			R5W	1	<a href="#">145TA2680</a>
12	5			C5W	1	<a href="#">160TA1122</a>
12	21			P21W	1	<a href="#">145TA2673</a>
12	21	5		P21/5W	1	<a href="#">145TA2099</a>
12	60	55		H4	1	<a href="#">160TA1121</a>
			Fuse 15A		1	<a href="#">106TA4955</a>
			Fuse 20A		1	<a href="#">106TA4956</a>
			Fuse 30A		1	<a href="#">103TA2770</a>



REF [160TA1120](#) – Complete box

**PHILIPS**

## KIT H7 – 12V

U1 (V)	P1 (W)	P2 (W)	Remark	ECE fitting	Quantity box	REF
12	4			T4W	1	<a href="#">145TA2682</a>
12	5			R5W	1	<a href="#">145TA2680</a>
12	5			C5W	1	<a href="#">160TA1122</a>
12	21			P21W	1	<a href="#">145TA2673</a>
12	21	5		P21/5W	1	<a href="#">145TA2099</a>
12	55			H7	1	<a href="#">145TA2681</a>
			Fuse 15A		1	<a href="#">106TA4955</a>
			Fuse 20A		1	<a href="#">106TA4956</a>
			Fuse 30A		1	<a href="#">103TA2770</a>



REF [160TA1126](#) – Complete box

**PHILIPS**

## KIT H1/H7 – 12V

U1 (V)	P1 (W)	Remark	ECE fitting	Quantity box	REF
12	5		W5W	1	<a href="#">160TA1125</a>
12	10		R10W	1	<a href="#">145TA2676</a>
12	10		SV8.5-8	1	<a href="#">145TA2683</a>
12	21		P21W	1	<a href="#">145TA2673</a>
12	21	Orange	PY21W	1	<a href="#">160TA1124</a>
12	55		H7	1	<a href="#">145TA2681</a>
12	55		H1	1	<a href="#">145TA2684</a>
		Fuse 10A		2	<a href="#">106TA4954</a>
		Fuse 20A		1	<a href="#">106TA4956</a>



REF [160TA1123](#) – Complete box

**PHILIPS**



## KIT H4 – 24V

U1 (V)	P1 (W)	P2 (W)	Remark	ECE fitting	Quantity box	REF
24	4			T4W	1	<a href="#">160TA1133</a>
24	5			R5W	1	<a href="#">160TA1131</a>
24	5			C5W	1	<a href="#">160TA1132</a>
24	10			R10W	1	<a href="#">160TA1130</a>
24	21			P21W	1	<a href="#">145TA2674</a>
24	75	70		H4	1	<a href="#">160TA1129</a>
			Fuse 15A		1	<a href="#">106TA4955</a>
			Fuse 20A		1	<a href="#">106TA4956</a>
			Fuse 30A		1	<a href="#">103TA2770</a>



REF [160TA1128](#) – Complete box

**PHILIPS**

## KIT H7 – 24V

U1 (V)	P1 (W)	Remark	ECE fitting	Quantity box	REF
24	4		T4W	1	<a href="#">160TA1133</a>
24	5		R5W	1	<a href="#">160TA1131</a>
24	5		C5W	1	<a href="#">160TA1132</a>
24	10		R10W	1	<a href="#">160TA1130</a>
24	21		P21W	1	<a href="#">145TA2674</a>
24	70		H7	1	<a href="#">160TA1135</a>
		Fuse 15A		1	<a href="#">106TA4955</a>
		Fuse 20A		1	<a href="#">106TA4956</a>
		Fuse 30A		1	<a href="#">103TA2770</a>



REF [160TA1134](#) – Complete box

**PHILIPS**



# MAINTENANCE, REPAIR & OPERATION



## DIGITAL MULTIMETER

### REF 142TA3131

- AC/DC voltage: 600 V
- AC/DC current: 10 A
- Diode test
- Transistor test
- Continuity test with buzzer
- Resistance
- Capacitance
- Data hold
- Low battery indication
- Backlight
- 9 V battery and protection holster included
- CAT.II 600 V



## FLUKE® 175 – DIGITAL MULTIMETER

### Versatile meters for field service or bench repair

These meters have the features needed to find most electrical, electromechanical and heating and ventilation problems.

They are simple to use and have significant improvements over Fluke's original 70 Series like True RMS, more measurement functions, conformance to the latest safety standards, and a much larger display that is easier to view.

#### Features:

True RMS measurements	AC
Digital display counts, updates 4 times per second	6000
Analog bargraph/33 segments, updates 40 times per second	✓
Auto and manual ranging	✓
Display hold and AutoHOLD®	✓
Min-Max-Average recording mode with Min/Max Alert	✓
Smoothing mode allows filtering of rapidly changing inputs	✓
Audible continuity and diode test	✓
Test lead alert	✓
Unsafe voltage alert warns for voltages above 30 V	✓
Low battery indication	✓
Ergonomic case with integrated holster	✓
Easy battery and fuse exchange without opening the complete case	✓
Selectable sleep mode preserves battery life	✓

#### Specifications:

Functions	Max range	Max resolution	Accuracy
Voltage DC	1000 V	0,1 mV	± (0,15% + 2)
Voltage AC	1000 V	0,1 mV	± (1,0% + 3)
Current DC	10 A	0,01 mA	± (1,0% + 3)
Current AC	10 A	0,01 mA	± (1,5% + 3)
Resistance	50 MΩ	0,1 Ω	± (0,9% + 1)
Capacitance	10 000 μF	1 nF	± (1,2% + 2)
Frequency	100 kHz	0,01 Hz	± (0,1% + 1)
Temperature	-40 °C to 400 °C	0,1 °C	

Accuracies are best accuracies for each function



### REF 131TA8447

#### Fluke® 175

- Battery life: 200 hours typical (alkaline)
- Size (H x W x D): 190 x 85 x 45 mm
- Weight: 0,42 kg
- Warranty: lifetime



True RMS

On all inputs



#### Included accessories:

Test leads with 4 mm lantern tips and protective cap, installed 9 V battery and user's manual.

#### Recommended accessories:



REF 131TA8448 C90 REF 131TA8445 i1010 REF 134TA8375 TLK220 eur

# FLUKE®

TVH is an official Fluke® dealer



## ALKALINE BATTERIES

Size	Type	Voltage (V)	Blister qty	REF	Box qty	REF/box
	3LR12	4,5	1	<a href="#">106TA9003</a>		
AAA	LR3	1,5	4	<a href="#">106TA9000</a>	10	<a href="#">163TA8917</a>
AA	LR6	1,5	4	<a href="#">106TA9001</a>	40	<a href="#">163TA8918</a>
C	LR14	1,5	2	<a href="#">106TA9002</a>	20	<a href="#">163TA8919</a>
D	LR20	1,5	2	<a href="#">106TA8998</a>	20	<a href="#">163TA8920</a>
E	6LR61	9	1	<a href="#">106TA8999</a>	20	<a href="#">163TA8921</a>



## RECHARGEABLE BATTERIES NI-MH

Size	Type	Voltage (V)	mAh	Blister qty	REF
AAA	LR3	1,2	900	4	<a href="#">145TA1813</a>
AA	LR6	1,2	2100	4	<a href="#">145TA1812</a>
C	LR14	1,2	2200	2	<a href="#">164TA9405</a>
D	LR20	1,2	2600	2	<a href="#">141TA6698</a>
E	6LR61	8,4	150	1	<a href="#">141TA6699</a>



## BUTTON CELL BATTERIES

Type	Voltage (V)	Units	REF
SR44W	1,55	1	<a href="#">141TA6700</a>
LR44	1,5	1	<a href="#">141TA6701</a>
CR1620	3	1	<a href="#">141TA6702</a>
CR2016	3	1	<a href="#">141TA6703</a>
CR2025	3	1	<a href="#">141TA6704</a>
CR2032	3	1	<a href="#">141TA6705</a>
CR2430	3	1	<a href="#">141TA6706</a>
CR2450	3	1	<a href="#">141TA6707</a>

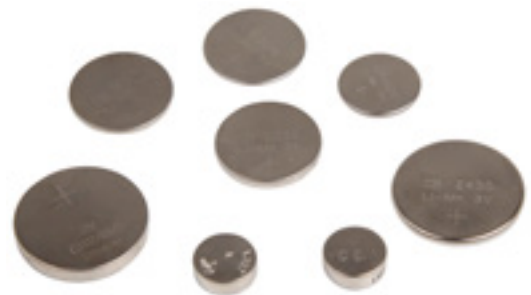

## MULTI-CHARGER NIMH



### REF [139TA3248](#)

- For batteries AA, AAA, C, D, 9 V
- Possibility to charge 8 batteries at once (8 x AA, 8 x AAA, 4 x C, 4 x D, 1 x 9 V)



## CABLE TIES

Width	Length	Pack quantity	REF white	REF black
2,5 mm	98 mm	100 pieces	<a href="#">111TA3872</a>	<a href="#">111TA3884</a>
3,6 mm	140 mm	100 pieces	<a href="#">111TA3873</a>	<a href="#">111TA3885</a>
4,5 mm	160 mm	100 pieces	<a href="#">111TA3874</a>	<a href="#">111TA3886</a>
4,8 mm	200 mm	100 pieces	<a href="#">111TA3875</a>	<a href="#">111TA3887</a>
4,8 mm	295 mm	100 pieces	<a href="#">111TA3876</a>	<a href="#">111TA3888</a>
4,8 mm	370 mm	100 pieces	<a href="#">111TA3877</a>	<a href="#">111TA3889</a>
4,8 mm	178 mm	100 pieces	<a href="#">111TA3878</a>	<a href="#">111TA3890</a>
7,8 mm	360 mm	100 pieces	<a href="#">111TA3879</a>	<a href="#">111TA3891</a>
7,8 mm	540 mm	100 pieces	<a href="#">111TA3880</a>	<a href="#">111TA3892</a>
12,6 mm	500 mm	50 pieces	<a href="#">111TA3881</a>	<a href="#">111TA3893</a>
12,6 mm	730 mm	50 pieces	<a href="#">111TA3882</a>	<a href="#">111TA3894</a>
12,6 mm	1000 mm	50 pieces	<a href="#">111TA3883</a>	<a href="#">111TA3895</a>



- Temperature-resistant: -40 °C up to 80 °C
- Melting point: 250 °C
- Resistant against: oil, petrol, seawater, solvents, mold, diluted light organic acids and alkalines





## COUNTERSUNK SCREWS AND NUTS M3-M5

**REF 107TA5446**

- 480 pieces
- Bicro zinc
- Metric
- DIN 965 + 934

Sizes	Quantity	Sizes	Quantity
M3 x 10	10	M6 x 16	40
M3 x 20	10	M6 x 50	40
M4 x 16	10	M3	20
M4 x 30	25	M4	35
M5 x 16	35	M5	105
M5 x 30	20	M6	80
M5 x 40	50		



## FINISHED HEXAGON BOLTS AND HEXAGON NUTS M5-M12

**REF 131TA6976**

- 950 pieces
- Steel 8.8, zinc-plated
- Metric ISO 4017
- DIN 934

Sizes	Quantity	Sizes	Quantity
M5 x 10 mm	100	M10 x 30 mm	10
M5 x 16 mm	75	M10 x 40 mm	10
M5 x 20 mm	60	M12 x 30 mm	5
M6 x 16 mm	50	M12 x 40 mm	5
M6 x 20 mm	50	M5	235
M6 x 25 mm	40	M6	140
M8 x 20 mm	25	M8	70
M8 x 25 mm	25	M10	20
M8 x 30 mm	20	M12	10



## 3-PIECE STEP DRILL SET



**REF 143TA3171**

HSS: 4-12, 4-20, 4-30 mm



## REFLECTOR FOR FORKLIFT



**REF 107TA8060**

- Height: 350 mm
- Fixation: triangle
- ECE 27

## FIRST-AID KIT EURO

**REF 140TA8638**

Small first-aid kit which is useful for cars, trekking, camping, boy scout, ...

**Contents:**

- 1 triangular bandage TNT 96 x 96 x 136 cm
- 2 adhesive plasters 10 x 6 cm
- 1 pair of scissors 10 cm
- 1 plastic tweezers
- 1 cotton wool pack 20 g
- 1 pack of 10 assorted adhesive plasters
- 2 gauze bandages 7 cm
- 1 adhesive plaster roll 5 x 2,5 cm
- 1 pair of gloves
- 2 packs of sterile TNT pads 1 x 1 cm
- 1 PIC
- 3 packs of 8 ass sachets soap/disinfectant/ammonium
- 1 instant ice pack
- Guidance leaflet 5 languages



## FIRE EXTINGUISHER

**REF 107TA8110**

- 1 kg
- Furnace class
- In function of the furnace, we use one or more designated fire extinguishers. The following badges that are located on the fire extinguishers denote the class it is suitable for.

**Powder extinguisher supplied with wall-mounting bracket!**

**Only approved for Belgium!**



**Class A: wood, paper, textile, carton. These are fires with brand formation, also called 'dry fires'.**

Use fire extinguisher with universal ABC powder



**Class B: liquid fires (alcohol, oil, grease, paint, hydrocarburates)**

Use fire extinguisher with universal ABC powder



**Class C: gas fires (gas, methane, butane, propane ...)**

Use fire extinguisher with universal ABC powder





## SAFETY JACKETS

- REF [123TA5548](#) – Uni-size, yellow
  - REF [123TA5549](#) – Uni-size, orange
  - REF [140TA8863](#) – M, yellow
  - REF [107TA8089](#) – L, yellow
  - REF [107TA8090](#) – XL, yellow
  - REF [107TA8091](#) – XXL, yellow
  - REF [107TA8092](#) – XXXL, yellow
- EN 471



## WORKEASY BLACK

- REF [143TA6973](#) – Size: 6
- REF [143TA6974](#) – Size: 7
- REF [143TA6975](#) – Size: 8
- REF [143TA6976](#) – Size: 9
- REF [143TA6977](#) – Size: 10
- REF [143TA6978](#) – Size: 11

**Recommendations:**

Fine handling in a dry environment

**Applications:**

- Assembly and electrical components (semi-conductors, microprocessors)
- Separation of small items (household appliances, automotive industry, nuts and bolts)
- Electronic

**Advantages:**

- Exceptional dexterity and breathability
- Without silicone

**Standard:**

- Cat II
- EN 420
- EN 388:3121





## CONTACT CLEANER

**REF 143TA6892**

- Effective precision cleaner for electrical/electronic equipment
- Quickly cleans contacts and components
- Removes flux traces, light oils, finger prints and other contaminants
- 500 ml



## LECTRA CLEAN II

**REF 143TA6898**

- Electric motor, parts and equipment degreaser
- Removal of heavy soil like grease, oil, dirt and other contaminants
- Its high flashpoint (63 °C) makes it suitable for use on large pieces and improves application safety
- 500 ml



## 2-26 ELECTRO

**REF 143TA6919**

- Multi-purpose maintenance for electrical equipment
- Prevents electrical and electronic malfunction caused by water penetration, humidity, condensation or corrosion
- 500 ml



## INSECT CLEANER

**REF 107TA8507**

- High-quality, intensive cleaner to remove insects
- 500 ml



## DE-ICER

**REF 139TA3290**

- A high-performance de-icer spray, suitable for use on vehicle windscreens. Contains antifreeze to help prevent refreezing
- 500 ml





## LOW STRENGTH THREADLOCKER

### REF 143TA3464

- Low strength, general purpose
- Max thread size: M36
- Service temperature range: -55 to 150 °C
- Strength: medium
- Breakaway torque: 6 Nm
- Viscosity: 900–1500 mPa·s
- Fixture time: 25 min
- P1 NSF
- 50 ml

#### Loctite 222:

- Ideal for low-strength thread locking of adjusting screws, countersunk head screws and set screws
- Good on low strength metals which could break during disassembly, e.g. aluminium or brass



**LOCTITE**

## INSTANT ADHESIVE

### REF 143TA3515

- Toughened, black, slow
- Service temperature range: -40 to 80 °C
- Viscosity: 200 mPa·s
- Substrates:
  - Plastic: suited
  - Rubber: well suited
  - Metal: suited
- Flexible: suited
- Impact resistance: well suited
- Fixture time: 20–50 sec
- 20 g

#### Loctite 480:

- For applications where shock resistance is required or shock or peel loads are present
- Ideal for bonding metal to metal, to rubber or magnets
- Good resistance in humid environments



**LOCTITE**

## INSTANT ADHESIVE

### REF 143TA3520

- Gap filling, 2-component, low bloom
- Service temperature range: -40 to 80 °C
- Viscosity: gel
- Substrates:
  - Plastic: suited
  - Rubber: well suited
  - Metal: suited
  - Porous and/or acidic surfaces: well suited
- Fixture time: 90–150 sec
- 10 g

#### Loctite 3090:

- For applications with gaps up to 5 mm or excess of adhesive
- For applications where cosmetic aspects and low bloom is required
- For porous substrates such as wood, paper, leather, cork and fabric



**LOCTITE**



## 9-PIECE REVERSIBLE GEAR WRENCH – METRIC



### REF 139TA1679

#### Contents:





9 reversible gear wrenches: 8 – 10 – 11 – 12 – 13 – 14 – 15 – 17 – 19 mm



## 39-PIECE 1/4" COMBINATION SET

### REF 143TA3806

#### Contents:

-  11 hexagon sockets:  
5 - 5,5 - 6 - 7 - 8 - 9 - 10 - 11 - 12 - 13 - 14 mm
-  4 slotted bits:  
0,5 x 3 - 0,8 x 5,5 - 1 x 5,5 - 1,2 x 6,5 mm
-  4 Phillips bits:  
PH0 - PH1 - PH2 - PH3
-  7 star bits:  
T8 - T10 - T15 - T20 - T25 - T30 - T40
-  5 hexagon bits:  
3 - 4 - 5 - 6 - 8 mm
  - 1 bit holder socket: 1/4" x 1/4"
  - 1 x 72-teeth ratchet
  - 1 spinner
  - 1 sliding T-handle
  - 2 extensions: 50 - 150 mm
  - 1 universal joint
  - 1 adapter: F1/4" x M3/8"



## CRIMPING PLIERS



### REF 106TA9500

- For cutting cables, stripping wire and crimping insulated terminals
- Capacity: 0,75–6 mm<sup>2</sup>
- Length: 230 mm





## KIT LIGHT TERMINALS

### REF 164TA8077

With professional crimp pliers

- |                        |                    |
|------------------------|--------------------|
| 50 x  L : 6,3 x 0,8 mm | 50 x  M8           |
| 50 x  L : 25 mm        | 50 x  L : 25 mm    |
| 50 x  6,3 x 0,8 mm     | 50 x  Ø : 4 mm     |
| 50 x  M4               | 50 x  6,3 x 0,8 mm |
| 50 x  M5               | 50 x  Ø : 4 mm     |
| 50 x  M6               | 50 x  6,3 x 0,8 mm |



## 12-PIECE INSULATED (1000 V) SLOTTED AND PHILLIPS SCREWDRIVER SET

### REF 142TA1927

Contents:

- 7 slotted screwdrivers:  
2,4 x 75 – 3 x 100 – 3,5 x 100 – 4 x 100 – 5,5 x 125 –  
6,5 x 150 – 8 x 175 mm
- 4 Phillips screwdrivers:  
PH0 x 60 – PH1 x 80 – PH2 x 100 – PH3 x 150 mm
- 1 induction circuit tester



## 3 PIECE PLIERS SET

### REF 127TA8106

1169BM/D3

Contents:

- Long needle nose pliers: 160 mm
- Combination pliers: 180 mm
- Diagonal cutter: 160 mm



## UNIVERSAL TEST KIT FOR TRAILER SOCKET

REF 124TA2765 – 12V 7-pole

REF 134TA9204 – 12V 13-pole

- 1 test plug for testing the trailer wiring including the trailer lighting (battery included) (1 person)
- 1 test plug for testing the wiring of the trailer socket (2 persons)





NOTES

A series of horizontal dotted lines for taking notes.





A series of horizontal dotted lines for taking notes.



NOTES

A series of horizontal dotted lines for taking notes.





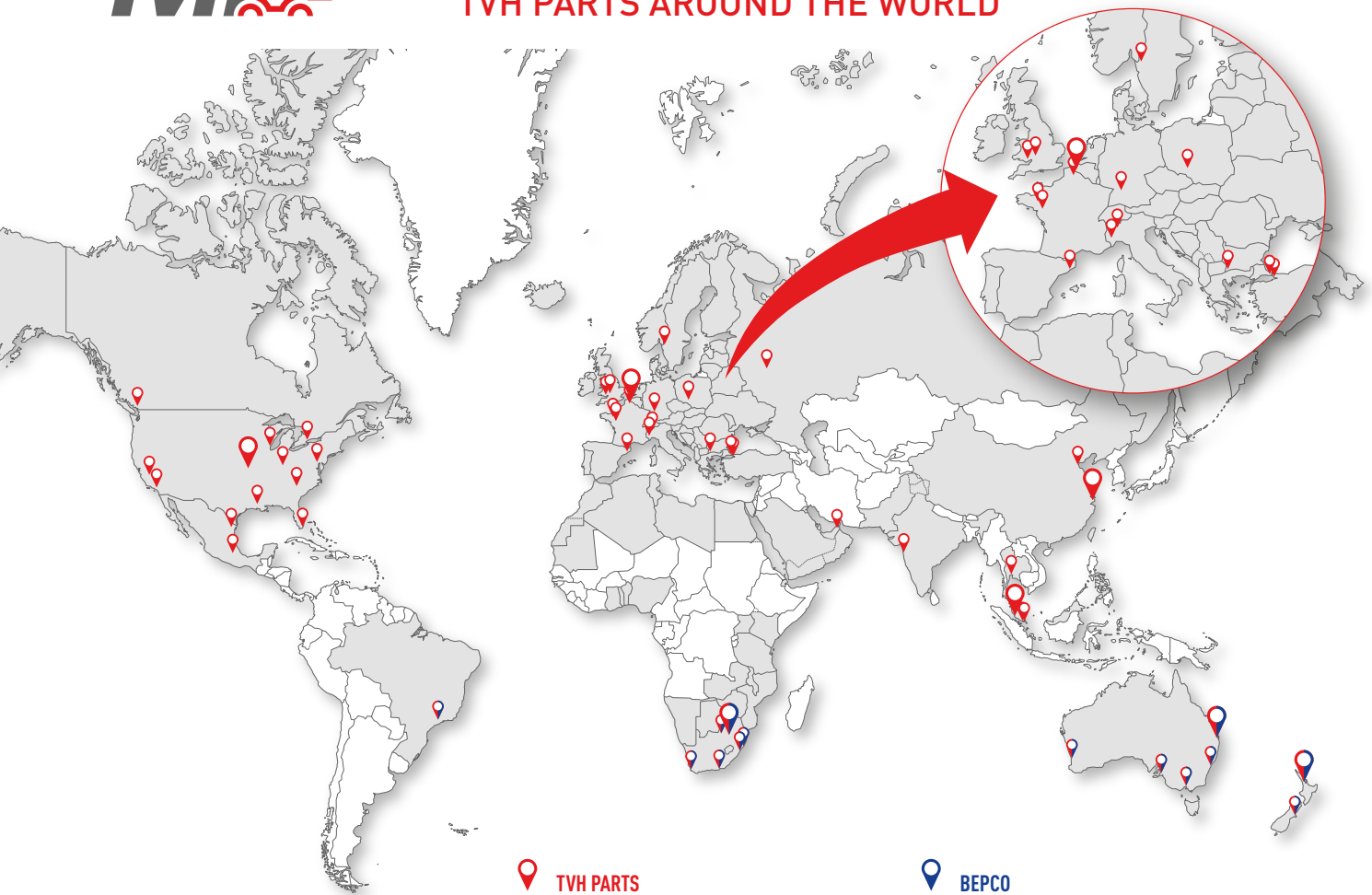





## TVH PARTS AROUND THE WORLD









### TVH PARTS

### BEPCO

-  **AUSTRALIA**  
TVH AUSTRALASIA PTY LTD  
Dandenong South (Melbourne, Victoria) -  
Richlands (Brisbane, Queensland) -  
Welspool (Perth, West Australia) -  
Wetherill Park (Sydney, New South Wales) -  
Wingfield (Adelaide, South Australia)
-  **BELGIUM**  
TVH PARTS NV  
Waregem  
TVH GROUP NV  
Waregem
-  **BRASIL**  
TVH-DINAMICA PEÇAS LTDA  
Vinhedo
-  **BULGARIA**  
TVH BULGARIA LTD  
Petrich
-  **CANADA**  
TVH CANADA LTD  
Mississauga (Ontario) - Port Coquitlam (British Columbia)
-  **CHINA**  
TVH TRADING (SHANGHAI) CO, LTD  
Shanghai - Tianjin
-  **FRANCE**  
TVH FRANCE SASU  
Wattrelos  
FRANCE HAYON SERVICE SAS  
Châteaubourg  
GLACES DISTRIBUTION INTERNATIONALE - G.D.I. SAS  
Beaufort-en-Vallée
-  **GERMANY**  
GLASSINTER GMBH  
Kirchheim unter Teck

-  **INDIA**  
TVH INDIA PVT LTD  
Pune
-  **ITALY**  
TVH ITALIA SRL  
Marano Ticino (Novara) - Torino  
CAM SRL  
Marano Ticino (Novara)
-  **MALAYSIA**  
TVH MALAYSIA SDN BHD  
Johor Bahru - Shah Alam (Kuala Lumpur)
-  **MEXICO**  
TVH MEXICO, S DE RL DE CV  
Cuautitlán Izcalli (Mexico City) - Monterrey
-  **NEW ZEALAND**  
TVH NEW ZEALAND LTD  
Christchurch - East Tamaki (Auckland)
-  **POLAND**  
TVH POLSKA SP ZOO  
Tychy
-  **RUSSIA**  
TVH RUS LLC  
Dubrovka (Moscow)
-  **SINGAPORE**  
TVH SINGAPORE PTE LTD  
Jurong
-  **SOUTH AFRICA**  
TVH PARTS SOUTH AFRICA LTD  
Briardene (Durban) - Isando (Johannesburg) -  
Korsten (Port Elizabeth) - Kraaifontein (Cape Town) - Lichtenburg -  
Richards Bay

-  **SPAIN**  
TVH IBERICA 2008 SL  
Badalona (Barcelona)
-  **SWEDEN**  
TVH NORDIC AB  
Ed
-  **THAILAND**  
TVH PARTS (THAILAND) LIMITED  
Bangkok
-  **TURKEY**  
TVH YEDEK PARCA TICARET AŞ  
Arnavutköy (Istanbul, European) - Tuzla (Istanbul, Asian)
-  **UNITED ARAB EMIRATES**  
TVH MIDDLE EAST FZE  
Sharjah
-  **UNITED KINGDOM**  
TVH UK LTD  
Coventry  
RENTACLAMP (COVENTRY) LIMITED  
Coventry  
CAB PARTS & ACCESSORIES LIMITED  
Crickhowell
-  **USA**  
TVH PARTS CO  
Duncan (South Carolina) - Fresno (California) - Grayslake (Illinois) -  
Harrisburg (Pennsylvania) - Miami (Florida) - Mira Loma (California) -  
Olathe (Kansas) - Shreveport (Louisiana)  
C-TECH INDUSTRIES LLC  
West Chester Township (Ohio)  
SUPERIOR SIGNALS, INC  
Olathe (Kansas)

### SALES REPRESENTATION IN THE FOLLOWING COUNTRIES:

Albania, Algeria, Austria, Bahrain, Belarus, Benin, Bosnia, Botswana, Canary Islands, Croatia, Cyprus, Denmark, Djibouti, Egypt, Estonia, Finland, Ghana, Greece, Hong Kong, Iceland, Ireland, Kosovo, Kuwait, Latvia, Lesotho, Libya, Lithuania, Macedonia, Malawi, Malta, Morocco, Mauritania, Moldova Republic, Montenegro, Mozambique, Namibia, Nigeria, Norway, Oman, Pakistan, Portugal, Qatar, Saudi Arabia, Serbia, Slovenia, Swaziland, Switzerland, Taiwan, Togo, Tunisia, Ukraine, Yemen, Zambia, Zimbabwe.

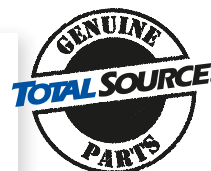

Go to **downloads** on [www.tvh.com](http://www.tvh.com) to find all catalogues.

## Consumables & accessories

REF 21713862

Our Consumables & accessories catalogue contains an extensive range of safety products for your personnel, machines and warehouse, all types of tools, a wide variety of warehouse equipment, a wide range of oils, sprays, paint & accessories and practical accessories for your lift truck or warehouse equipment.

## Engine parts

REF 34167446

Our Engine parts catalogue contains an overview of engine parts for all different brands. Pistons, liners, valves, valve guides, bearings, gasket kits ...



AT YOUR SERVICE  
IN 37 LANGUAGES  
[info@tvh.com](mailto:info@tvh.com)

REF-31072165 · 10-2017 · edition 1 · SL · Value: € 10,-



# Quality parts cheaper



FOLLOW US



PARTS & ACCESSORIES



COMPANY MOVIE



TVH PARTS NV  
Brabantstraat 15 · 8790 Waregem · Belgium  
T +32 56 43 42 11 · F +32 56 43 44 88 · [info@tvh.com](mailto:info@tvh.com) · [www.tvh.com](http://www.tvh.com)

**TVH PARTS**