

Tyres, rims & accessories

REF 24337660



TVH PARTS NV • PARTS & ACCESSORIES DIVISION
Brabantstraat 15 • BE-8790 Waregem
T +32 56 43 42 11 • F +32 56 43 44 88 • parts@tvh.com • www.tvh.com



TYRES, RIMS & ACCESSORIES

For all our latest catalogue updates and company info: www.tvh.com

-  Most articles stated in this catalogue are available from stock, unless they were sold out after the publication of this catalogue. Contact us if you require a similar article that is not shown in this catalogue: alternatives might be available. TVH is a supplier of spare parts and accessories suitable for OEM-equipment. OEM-references and makes are purely indicative and do not imply that the accessories and/or spare parts originate from the original equipment or parts manufacturer. Please consult our general terms and conditions of sale on www.tvh.com/avv.
-   De meeste in deze catalogus vermelde artikelen zijn uit voorraad leverbaar, tenzij ze na publicatie van deze catalogus uitverkocht werden. Contacteer ons indien u een gelijkaardig artikel wenst dat niet in deze catalogus is opgenomen: het is mogelijk dat wij ook dit kunnen leveren. TVH is een leverancier van reserveonderdelen en accessoires geschikt voor OEM-uitrusting. OEM-referenties en merken zijn enkel indicatief en betekenen niet dat de accessoires en/of onderdelen afkomstig zijn van de originele toestel- of onderdelenfabrikant. Gelieve onze algemene verkoopsvoorwaarden te consulteren op www.tvh.com/avv.
-  La plupart des articles mentionnés dans ce catalogue sont disponibles sauf si épuisement du stock à la publication de ce catalogue. Contactez-nous si vous souhaitez un article similaire qui n'est pas repris dans ce catalogue : il est possible que nous pouvons vous le fournir. TVH est un fournisseur de pièces détachées et d'accessoires adaptables sur des marques constructeurs. Les références et marques constructeurs sont uniquement indicatives et n'impliquent pas que les accessoires et/ou pièces proviennent du fabricant de la machine ou de la pièce d'origine. Veuillez consulter nos conditions générales de vente sur www.tvh.com/avv.
-  Die in dieser Liste aufgeführten Artikel sind in der Regel ab Lager lieferbar es sei denn, sie sind nach der Veröffentlichung des vorliegenden Katalogs ausverkauft. Kontaktieren Sie uns wenn Sie einen ähnlichen Artikel benötigen dieser aber nicht im Katalog enthalten ist: Alternativen könnten verfügbar sein. TVH ist Lieferant von Ersatzteilen und Zubehör die für die OEM – Ausstattung geeignet sind. OEM-Referenzen und Marken sind rein Indikativ und bedeuten nicht, dass das Zubehör und/oder Ersatzteile vom Originalgeräte- oder Ersatzteilerhersteller sind. Druckfehler vorbehalten. Alle Verkäufe unterliegen den Allgemeinen Geschäftsbedingungen www.tvh.com/avv.
-  La mayoría de los artículos que figuran en este catálogo se encuentran en stock, a menos que tras la publicación de este catálogo se hayan agotado. Contacte con nosotros si desea un artículo similar que no se halle en este catálogo : es posible que podamos ofrecerle aquel que usted necesita. TVH es un proveedor de recambios y accesorios adecuados para equipos OEM. Las referencias y marcas OEM mencionadas son meramente indicativas y no implican que los accesorios y / o recambios procedan del fabricante de maquinaria o recambios original. Por favor, consulte nuestras condiciones de venta en www.tvh.com/avv.
-  La maggior parte dei ricambi elencati in questo catalogo sono a stock, a meno che dopo la pubblicazione di questo catalogo sono stati venduti. Contattecì se desiderate un articolo simile che non è riportato in questo catalogo: è possibile che possiamo offrire anche questi. TVH è un fornitore di pezzi di ricambio e accessori per OEM, riferimenti OEM e marche sono solo indicativi e non implicano che gli accessori e/o di componenti derivino dal costruttore originale o dal produttore del componente. Si prega di consultare i nostri termini di vendita su www.tvh.com/avv.
-  Części z tego katalogu są zazwyczaj na stanie magazynowym. Również części które nie są wyszczególnione w katalogu mogą być dostarczone na zamówienie w najkrótszym możliwym terminie. Opis części O.E.M. jest używany informacyjnie i nie wskazuje na to, że dany produkt jest wyprodukowany przez podanego producenta. Zawartość katalogu może ulec zmianie bez wcześniejszego informowania o tym. Wszystkie użyte zdjęcia, rysunki, nazwy marek, opis i numery służą tylko do identyfikacji.
-  Запчасти из настоящего списка, как правило, имеются в запасе, если только он не распродан. Прочие, не фигурирующие в списке артикулы, могут быть поставлены в самые кратчайшие сроки. Указание оригинальных номеров производителя не предполагает обязательного оригинального происхождения самих деталей. Данный список может изменяться без предварительного уведомления. Все использованные фото, рисунки, иллюстрации, названия брендов, наименования и номера служат исключительно для цели идентификации.



© April 2015 TVH Group NV, Brabantstraat 15, 8790 Waregem, Belgium.

TVH®, TotalSource®, TotalLifter® and Climax® are registered trademarks. All other trademarks and tradenames referred to in this publication are the property of their respective owners. All rights reserved. No part of this publication may be reproduced or communicated in any form or by any means, electronic or mechanical, including copying, recording or use in an information storage or retrieval system, without prior and explicit permission of TVH Group NV. TVH is a supplier of after-market spare parts and accessories that are fitted for maintenance and repair of OEM-equipment. Printing errors reserved. Photographs and illustrations are included for reference purposes only. All sales are subject to the general terms & conditions of sale on www.tvh.com/avv.



Dear customer,

More than 45 years ago, in 1969, the success story of TVH began. Mr Paul Vanhalst and Mr Paul Thermote, neighbours and school friends, joined forces and started with the purchase and repair of agricultural machines and used lift trucks.

Increasing industrialisation led to a growing need for lift trucks and lift truck parts. Slowly but surely, TVH was growing into a global player, thanks to the success of the product and customer service, but also thanks to acquisitions. TVH turned into an all-round supplier, a real one-stop shop, by adding hand pallet trucks, hand trolleys, lifting cranes ... to its range and by setting up a domestic rental division.

TVH Group is organized in 2 important activities: Parts & Accessories and Rental & Equipment. This last activity has 3 divisions, namely Equipment Division (sales of second-hand lift trucks and aerial work platforms), Rental Division (short- and long-term renting of lift trucks and aerial work platforms) and Service & Repair Division. The Rental Division is active in Belgium, the Netherlands, Luxemburg, Czech Republic, Germany, Poland, Slovakia, Hungary, Romania and Serbia. The Service & Repair Division is a service we only offer in Belgium. The Parts & Accessories and the Equipment Division are active in more than 170 countries worldwide.

After all these years, the business is still in family hands and has grown from 2 founders, to a workforce of almost 4000 employees worldwide, in 5 continents. The day-to-day management has now been handed over to the second generation.

The Thermote & Vanhalst families



Watch our company movie.





PARTS & ACCESSORIES DIVISION *Parts & Accessories Division*



TVH is your all-round supplier of quality parts and accessories for material handling, industrial vehicles and agricultural equipment. You get fast answers on any offer, order or technical question from our dedicated sales and technical departments. We continually expand our product range by following new trends and looking for new partnerships, to make sure you will find absolutely everything you need right here at TVH.

- More than 100 000 m² of warehousing
- Computer-controlled stock management
- More than 600 000 stock items
- More than 21 000 000 known references
- Technically-skilled employees
- Assistance in 32 languages
- Same-day shipment, next-day delivery
- One-stop shop
- Webshop & online support



PARTS & ACCESSORIES



Strong brands, guaranteed quality

We understand that the success of our company only exists if we are a trusted source of products and services that contribute to your success. That is why TVH's product assortment consists of top quality brands.

Read all about this under 'Product range' on www.tvh.com



This is only a selection of brands we can offer. Exceptions apply to certain products/countries.





Parts & Accessories Division

Hydraulic and mechanical attachments

With CAM System® you benefit from over 50 years of experience in design and production of lift truck attachments. The full range of mechanical and hydraulic attachments is recognized for its high qualitative standards and reliability.



Order your catalogue with prices to see an overview of this product range. Find our product leaflets and product movies on

www.camattachments.com



Sweepers

Sweep your way through dust and dirt! We offer a complete range of mechanical and hydraulic sweeper attachments.

Hydro Sweep_r

Maxi Sweep_r

Magnetic Sweep_r

Lazy Sweep_r

SmartSweep[®]



Handling equipment

Complete range of internal transport equipment as well as warehouse and workshop accessories.

TOTALLIFTER[®]

TOTALSOURCE[®]

Climax





A global view on parts & accessories

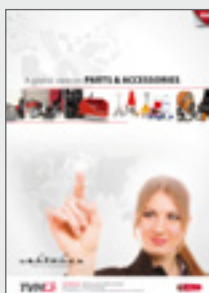

REF 21910709

This brochure gives you an overview of the products, parts and services TVH offers.

Consumables & accessories catalogue



REF 21713862

In the Consumables & accessories catalogue you get an overview of our range of maintenance and repair products for use in your workshop: personal safety products, repair & maintenance products, workshop consumables, warehouse accessories ...

Attachments & handling equipment

Product selection 2015-2016



REF 24010820

The Attachments & handling equipment product selection 2015-2016 shows a selection of what TVH can offer in the following ranges:

- Hand pallet trucks
- Scissor hand pallet trucks
- Warehouse equipment
- Trolleys
- Mechanical & hydraulic attachments
- Lift tables
- Stackers ...

Catalogues

Our catalogues give you information about the product groups, brands and makes in our range. The extensive and detailed information contains general product info, pictures, dimensions ... Go to downloads on www.tvh.com to find all catalogues and brochures.



- | | |
|--|---|
| <ul style="list-style-type: none"> • REF 15262190 Batteries, chargers & accessories • REF 20177702 Brushes • REF 21497415 Bulbs • REF 15282597 Chains & accessories • REF 21713862 Consumables & accessories • REF 10185471 Contactors & contacts • REF 21178582 Electronic accessories • REF 20777844 Energic Plus® battery chargers • REF 20177485 Engine parts • REF 10727802 Exhaust systems • REF 23096929 Fluke • REF 20177906 Fuses & fuse holders • REF 20447667 Grammer seats • REF 10550844 Hand pallet truck parts • REF 14702080 Hydraulic system parts • REF 19949421 Key switches • REF 12594102 Labels & decals | <ul style="list-style-type: none"> • REF 22802499 LPG system parts • REF 7872482 Mast rollers • REF 7882672 Paint & accessories • REF 7835233 Potentiometers & encoders • REF 7083552 Relays • REF 12726578 Replacement parts for Genie • REF 15069637 Replacement parts for Haulotte • REF 12613028 Replacement parts for JLG • REF 20769251 Replacement parts for scrubbers & sweepers • REF 14089352 Rubber tracks • REF 13991397 Seats & accessories • REF 6252659 Starters & alternators • REF 24154086 Tail lift parts • REF 20064130 Tyres, rims, rubber tracks & accessories • REF 7072186 Wheel brake & master cylinders • REF 6781097 Wheels, rollers & castors |
|--|---|

Discover our website!

On our website www.tvh.com, you can discover a lot of information on our product range. To show you more about our products and services, we create movies, catalogues and brochures. Go to downloads on www.tvh.com to view all movies about our new products, ecommerce tools, company movie ...





Webshop & online support

Visit our webshop where and when you want

Forwarding price inquiries and orders is fast, easy and only one click away. 24/7 available.



Receive your complete offer immediately

Use a TVH or OEM number to get price and availability. Even the reference on the part itself is often recognized in MyTotalSource.

Search online

• You have **machine or equipment details**? Use **MyPartsFinder** to find the spare part you need.



• You have the **technical details or specifications** of a part? Use **MyProductSearch** to find the spare part you need.



• Use our online **catalogues**.

• Haven't found the reference you were looking for? Fill out the technical sheet you can find in MyTotalSource ('Info & Promotions') or in this catalogue.

Place your order in just a few clicks

4 easy steps to send your order:

1. Create your order basket
2. Change your order
3. View your order
4. Confirm your order

mytotalsource.tvh.com

- **MyTotalSource app!**
Use MyTotalSource on your smartphone or tablet.
- **"Scan to order" system.** Just scan the bar code with your smartphone or bluetooth scanner and get a price and availability to complete your offer/order.

Request your login details now and benefit from the many advantages offered in MyTotalSource!

For any questions, call or mail our help desk for free support:
T +32 56 43 48 66 • ecommerce@tvh.com





Electronic parts

Our range includes printed circuit boards, electronic speed controllers, displays, chargers, contactors, joysticks, accelerators and directional switches.

Our electronics department is Europe's largest, best equipped and most diverse service centre for the repair of electronic parts for forklifts, aerial work platforms and industrial vehicles.

Find out more about our electronics department in our brochure (REF 20207048) or go to downloads on www.tvh.com to watch the movie.



Watch the movie about our Electronics department



Reconditioned parts

We offer you a unique range of reconditioned parts, at the best price. Reconditioned parts are sold with the same warranty as for a new part, at a price that can be up to 50% cheaper!

Electric motors, internal combustion engines, printboards, hydraulic pumps, transmissions, torque converters, radiators, steering axles, starters, alternators ... everything is in stock! TVH has invested in a wide range of test devices which allow us to pass stringent quality controls on various spare parts. The tests are designed in such a manner that a realistic work situation is generated during the tests.

Buying one of our reconditioned parts is the perfect alternative to buying a new spare part. Ask for the availability and the conditions! You can buy a reconditioned part with or without the return of an old unit (service exchange parts).



Reconditioned
Recycled
Reliable



Watch the movie about our reconditioned parts





TVH-bay

TVH's online shop with more than 1000 new and second-hand products at rock-bottom prices! Available in different languages.

The online shop to pick up real bargains

- Rock-bottom prices for a limited offer of hard-to-find parts and accessories
- A list of products per brand or product category
- A wide range of parts and accessories for lift trucks, handling equipment and related products
- All parts are available off the shelf, and can therefore be delivered quickly
- Frequently updated with new references

www.tvh.com/tvhbay

Second-hand attachments

More than 500 pieces in stock

TVH aims to invest in durability and pursues this as much as possible in its products. The range of second-hand attachments in original or completely revised condition is very extensive and varied: rotators, fork positioners, carpet booms, bale clamps, paper roll clamps ... All attachments are reconditioned by our dedicated in-house team.

We have second-hand attachments in our range for Bolzoni, CAM System, Cascade, Kaup, Kooi, Meyer ...

Discover our full range on www.tvh.com/tvhbay





EQUIPMENT DIVISION *Second-hand equipment*

- Specialist in lift trucks and aerial work platforms with a permanent stock of 1500 lift trucks and 250 aerial work platforms
- Telehandlers and all-terrain lift trucks
- Masts and attachments

Find a daily updated stock list on our search engine
myequipmentfinder.tvh.com



Electric warehousing

Electric hand pallet trucks (from 1,5–2 T) and stackers (from 1–1,6 T)



Climax®

www.climaxhandling.com

info@climaxhandling.com • T +32 56 43 41 19





*We offer a large selection of tyres, rims & rubber tracks.
What is mentioned in this brochure is not the complete program. Whatever brand or execution you cannot find here, don't hesitate to ask your personal sales contact.
We have over 10 000 tyres for different applications continuously on stock. Pre-fitting of the tyres on rims is possible.*



• Nice to know	2
• Basic super elastic tyres	4
• Standard super elastic tyres	6
• Premium super elastic tyres	8
• Industrial pneumatic tyres	10
• Premium industrial pneumatic tyres	12
• Skid steer tubeless pneumatic tyres	14
• Various OTR, agricultural and EM pneumatic tyres	16
• Press-on tyres: cylindrical and conical base	18
• Mould-on wheels	26
• Rims (wheels)	28
• Tyre press	32
• Tyre press – Fitting tools	34
• Tyre shop – Repair equipment	36
• Tyre shop – Tyre installation	43
• Accessories	48
• Ground support plates	51
• Stabilizer plates	52
• Rubber tracks	53
• Rubber pads	56



NICE TO KNOW

MyTotalSource

Your interactive online webshop for spare parts



The user-friendly search modules **MyPartsFinder** (search by brand and truck type) and **MyProductSearch** (search by specifications/technical info) allow you to always find the correct part!

Dimensions shown in this catalogue are standard dimensions. Measured dimensions may vary slightly.

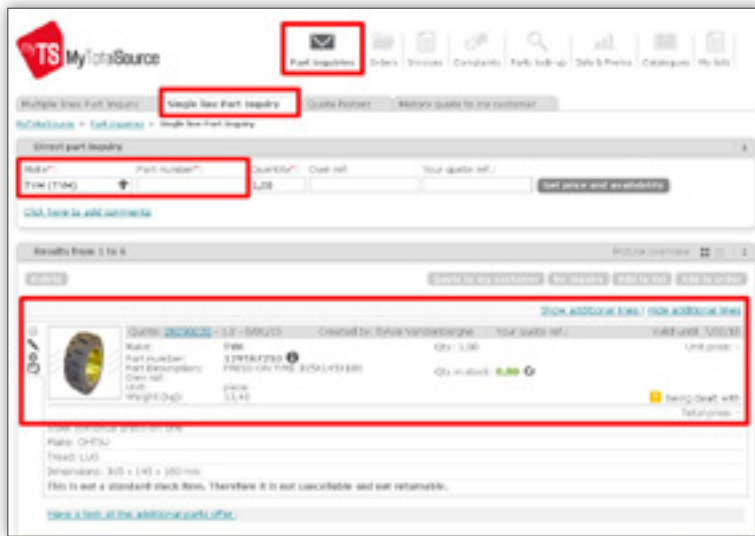

- **Single line part inquiry:** for a quick price and lead time of only 1 item
- **Multiple line part inquiry:** for price and lead time of several parts
- Instant price, availability and picture

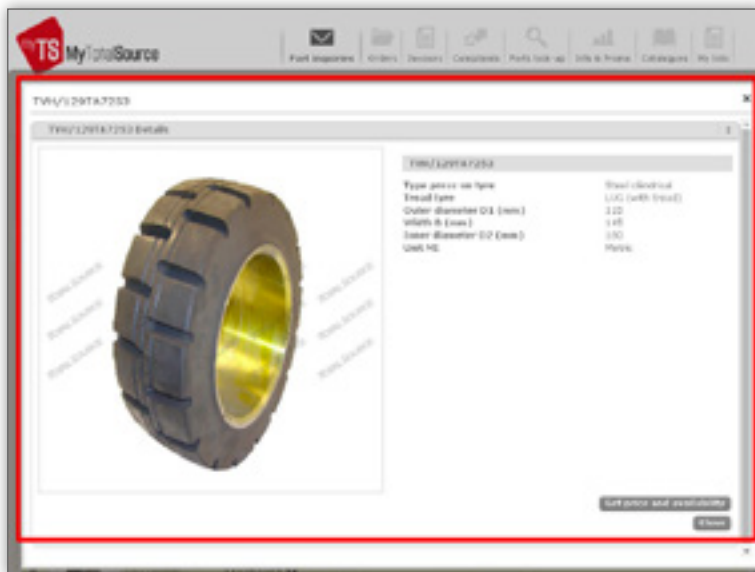

The references in the catalogue only contain the most important info, but once the REF is entered via MTS, then extra info can be consulted such as:

- Extra technical info
- Larger (and more specific) photographs

No login yet? Request your login details now via ecommerce@tvh.com

HELPDESK: T +32 56 43 48 66



NICE TO KNOW

MyTotalSource

Your interactive online webshop for spare parts



The user-friendly search modules **MyPartsFinder** (search by brand and truck type) and **MyProductSearch** (search by specifications/technical info) allow you to always find the correct part!

Dimensions shown in this catalogue are standard dimensions. Measured dimensions may vary slightly.

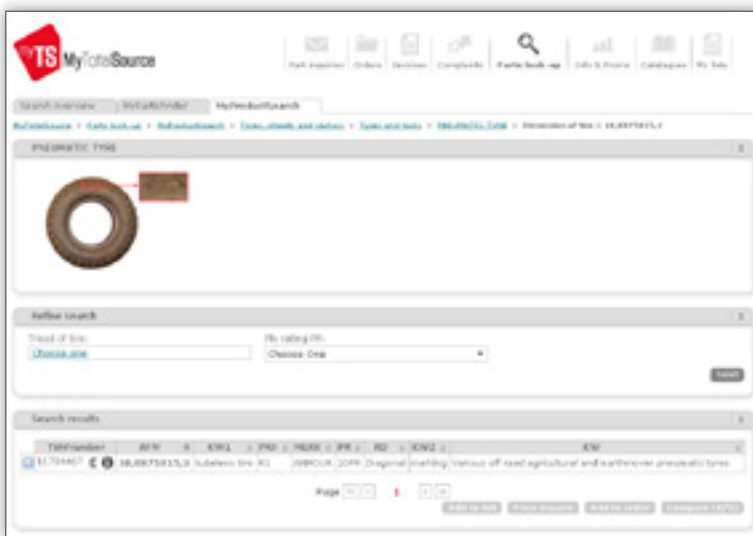

MyProductSearch

Find your consumables group

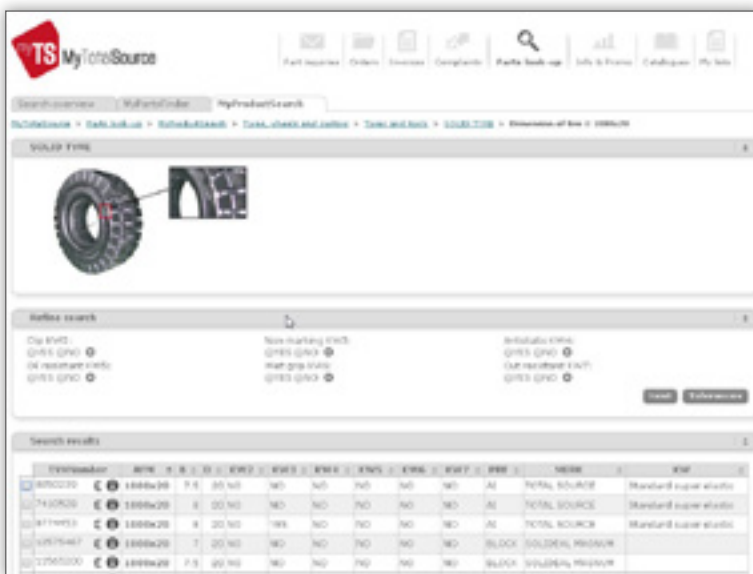

It is also possible to search further via MPS (MyProductSearch) for a similar part with other characteristics if necessary, or the parts can also be compared to each other.

No login yet? Request your login details now via ecommerce@tvh.com

HELPDESK: T +32 56 43 48 66



BASIC SUPER ELASTIC TYRES

BASIC SUPER ELASTIC TYRES

TotalSource® Basic super elastic tyres

These basic tyres from our TotalSource® range are ideal for daily, medium-duty use. They are composed of two layers and have a strong core with internal steel reinforcement rings. This results in a firm grip on the rim and a wear-resistant tread. The TotalSource® Basic solid rubber tyres all meet the international standards (ETRTO).



TOTALSOURCE®

TYRES, RIMS & ACCESSORIES

For all our latest catalogue updates and company info: www.tvh.com



BASIC SUPER ELASTIC TYRES

BASIC SUPER ELASTIC TYRES

Tyre size	Rim size	Tread pattern	Tyre dia ± 10 mm	Section width ± 5 mm	Approx net weight kg	Standard tyre REF	Clip tyre REF
400x8	3.00	SB	405	110	11	136TA1302	136TA1326
500x8	3.00	SB	440	120	16	136TA1303	136TA1327
15x4,5x8	3.00	SB	370	105	9	136TA1304	136TA1328
16x6x8	4.33	SB	405	145	14	136TA1305	136TA1329
18x7x8	4.33	SB	443	156	20	136TA1306	136TA1330
600x9	4.00	SB	520	141	24	136TA1307	136TA1331
21x8x9	6.00	SB	511	185	31	136TA1308	136TA1332
650x10	5.00	SB	555	160	32	136TA1309	136TA1333
23x9x10	6.50	SB	570	196	42	136TA1310	136TA1334
200x50x10	6.50	SB	453	186	22	136TA1311	136TA1335
700x12	5.00	SB	642	171	46	136TA1312	136TA1336
23x10x12	8.00	SB	575	225	44	136TA1313	136TA1337
27x10x12	8.00	SB	675	235	67	136TA1314	136TA1338
700x15	5.50	SB	721	181	52	136TA1315	136TA1339
700x15	6.00	SB	721	181	52	136TA1316	-
750x15	6.50	SB	740	191	74,5	136TA1317	-
815x15	7.00	SB	679	220	55	136TA1318	136TA1340
28x9x15	7.00	SB	679	220	55	136TA1318	136TA1340
250x15	7.00	SB	700	210	62	136TA1319	136TA1341
250x15	7.50	SB	700	210	62	136TA1320	136TA1342
825x15	6.50	SB	795	205	82	136TA1321	136TA1343
300x15	8.00	SB	803	241	100	136TA1322	136TA1344
355x65x15	9.75	SB	810	295	121	136TA1323	136TA1345
900x20	7.00	SB	990	250	127	136TA1324	-
1000x20	8.00	SB	1000	253	145	136TA1325	-



STANDARD SUPER ELASTIC TYRES

STANDARD SUPER ELASTIC TYRES

TotalSource® Standard super elastic tyres

Our standard tyres offer a solution for each normal application, within the limits of load and speed.

This types of tyre has a three-component structure, of which the inner layer is reinforced with steel rings to keep the tyre firmly on the rim.

The soft intermediate layer provides a cushioning effect that protects your vehicle and driver against heavy jolts. Furthermore this intermediate layer dissipates heat towards the exterior. This causes the tyre to overheat less rapidly. This way, this centre layer results in a longer life span, higher carrying capacity & wear-resistance, lower energy consumption and improved road-holding capabilities.



TOTAL SOURCE®

TYRES, RIMS & ACCESSORIES

For all our latest catalogue updates and company info: www.tvh.com



STANDARD SUPER ELASTIC TYRES

STANDARD SUPER ELASTIC TYRES

Tyre size	Rim size	Tread pattern	Tyre dia ± 10 mm	Section width ± 5 mm	Approx net weight kg	Standard tyre REF	Clip tyre REF	Standard non-marking tyre REF	Clip non-marking tyre REF
400x8	3.00	TO1	401	116	11,3	142TA3483	-	142TA3484	-
400x8	3.00	TO3	412	115	12,6	129TA6776	-	129TA6825	-
400x8	3.75	TS01	408	115	12,5	129TA6777	-	129TA6826	-
400x8	3.75	TO3	412	115	12,6	129TA6778	-	129TA6827	-
500x8	3.00	TO1	457	125	17,5	142TA3485	142TA3486	142TA3488	142TA3487
15x4,5x8	3.00	TO1	379	112	10,2	142TA3438	142TA3439	142TA3441	142TA3440
16x6x8	4.33	TO1	407	147	15,4	142TA3442	142TA3443	142TA3445	142TA3444
18x7x8	4.33	TO1	454	147	21	142TA3446	142TA3447	142TA3449	142TA3448
600x9	4.00	TO1	522	144	27,4	142TA3490	142TA3491	142TA3493	142TA3492
140x55x9	4.00	TO3	379	130	10,5	-	142TA3436	-	142TA3437
21x8x9	6.00	TO1	524	186	35,5	142TA3454	142TA3455	142TA3457	142TA3456
650x10	5.00	TO1	572	157	36,7	142TA3494	142TA3495	142TA3497	142TA3496
23x9x10	6.50	TO1	576	212	47,5	142TA3462	142TA3463	142TA3465	142TA3464
200x50x10	6.50	TO1	461	194	24,5	142TA3450	142TA3451	142TA3453	142TA3452
750x10	5.00	TS01	630	170	48	129TA6780	-	129TA6837	-
750x10	5.50	TS01	630	170	48	129TA6781	129TA6813	129TA6838	129TA6864
450x12	3.00	TS02	546	120	22,2	129TA6782	-	129TA6839	-
700x12	5.00	TO1	653	169	48,5	142TA3498	142TA3499	142TA3501	142TA3500
825x12	5.00	TS01	730	205	72	129TA6783	-	-	-
23x10x12	8.00	TO1	586	234	51,2	142TA3458	142TA3459	142TA3461	142TA3460
27x10x12	8.00	TO1	688	244	72	142TA3469	142TA3470	-	142TA3471
550x15	4.50	TO2	665	154	37	142TA3489	-	-	-
600x15	4.50	TS02	700	148	46,5	129TA6786	-	129TA6844	-
700x15	5.50	TO1	729	179	61,5	142TA3502	142TA3503	-	142TA3504
750x15	6.50	TS01	760	200	75	129TA6788	-	-	-
815x15	7.00	TO1	685	208	60,5	142TA3473	142TA3474	142TA3476	142TA3475
28x9x15	7.00	TO1	685	208	60,5	142TA3473	142TA3474	142TA3476	142TA3475
250x15	7.00	TO1	713	222	68	142TA3466	142TA3467	-	142TA3468
250x15	7.50	TS01	725	230	72	129TA6789	139TA3475	129TA6848	-
825x15	6.50	TO1	815	211	93,2	142TA3506	142TA3507	142TA3509	142TA3508
300x15	8.00	TO1	820	247	117,5	142TA3477	142TA3478	142TA3480	142TA3479
28x12,5x15	9.75	TO2	705	290	91,9	-	142TA3472	-	-
355x65x15	9.75	TO2	809	302	125	142TA3481	142TA3482	-	-
650x16	5.50	TS03	740	165	60	129TA6792	-	-	-
750x16	5.50	TO2	794	210	77,1	142TA3505	-	-	-
750x16	6.00	TS03	800	220	77,2	129TA6794	-	129TA6854	-
900x16	6.50	TS03	869	214	110	129TA6795	-	-	-
900x20	6.50	TS03	1000	240	153	129TA6797	-	-	-
900x20	7.00	TO2	974	224	123,9	142TA3510	-	-	-
1000x20	7.50	TS03	1030	250	170	129TA6798	-	-	-
1000x20	8.00	TS03	1030	250	170	129TA6799	-	-	-
1100x20	8.00	TS03	1050	270	170	129TA6800	-	-	-
1200x20	8.00	TS03	1100	285	195	129TA6801	-	-	-
1200x20	8.50	TS03	1100	285	231	129TA6802	-	-	-
1200x20	10.00	TS03	1100	285	231	129TA6803	-	-	-
1400x20	10.00	TS03	1250	328	340	129TA6804	-	-	-
1400x24	10.00	TS03	1330	325	390	129TA6805	-	-	-
1600x25	11.25	-	1440	390	600	On request	-	-	-
1800x25	13.00	-	1600	480	870	On request	-	-	-
17,5x25	14.00	-	1350	460	580	On request	-	-	-
23,5x25	19.50	-	1600	580	1100	On request	-	-	-
26,5x25	22.00	-	1730	650	1400	On request	-	-	-



PREMIUM SUPER ELASTIC TYRES



PREMIUM SUPER ELASTIC TYRES

TotalSource® Premium super elastic tyres

Our premium solid rubber tyres are mainly suitable for intensive use (e.g. three-shift system), applications with very heavy loads and very powerful machines. (e.g. Linde)

This type of tyre also has a three-component structure, of which the inner layer has been equipped with steel cables instead of rings. These woven cables ensure a smooth installation of the tyre and a good fixation of the tyre on the rim.

Another difference with the standard solid rubber tyres lies in the superior rubber compound, which results in the following advantages:

- lower heat build-up to resist extreme wear
- even better shock absorption
- improved stability, traction and braking power
- reduced vibrations
- longer life span

TSP



RIB



TOTALSOURCE®

TYRES, RIMS & ACCESSORIES

For all our latest catalogue updates and company info: www.tvh.com



PREMIUM SUPER ELASTIC TYRES

Tyre size	Rim size	Tread pattern	Tyre dia ± 10 mm	Section width ± 5 mm	Approx net weight kg	Standard tyre REF	Clip tyre REF	Non-marking tyre REF	Clip non-marking tyre REF
300x4	2.10	RIB	250	85	3,5	129TA6876	-	-	-
400x4	2.50	TSP	300	100	6,3	129TA6877	-	-	-
350x5	3.00	TSP	320	99	7,3	129TA6878	-	129TA6937	-
400x8	3.00	TSP	410	113	15,5	129TA6879	129TA6916	129TA6938	-
500x8	3.00	TSP	450	124	17	129TA6880	129TA6917	129TA6939	129TA6959
15x4,5x8	3.00	TSP	378	110	9,9	129TA6881	129TA6918	129TA6940	129TA6960
16x6x8	4.33	TSP	410	150	16,5	129TA6882	129TA6919	129TA6941	129TA6961
18x7x8	4.33	TSP	450	160	21	129TA6883	129TA6920	129TA6942	129TA6962
140x55x9	4.00	TSP	380	135	11	-	129TA6921	-	129TA6963
600x9	4.00	TSP	525	145	26	129TA6884	129TA6922	129TA6943	129TA6964
21x8x9	6.00	TSP	515	190	33,5	129TA6885	129TA6923	129TA6944	129TA6965
650x10	5.00	TSP	560	165	34	129TA6886	129TA6924	129TA6945	129TA6966
23x9x10	6.50	TSP	575	200	44	129TA6887	129TA6925	129TA6946	129TA6967
200x50x10	6.50	TSP	460	190	25	129TA6888	129TA6926	129TA6947	129TA6968
700x12	5.00	TSP	650	175	49	129TA6889	129TA6927	129TA6948	129TA6969
23x10x12	8.00	TSP	580	230	46	129TA6890	129TA6928	129TA6949	129TA6970
27x10x12	8.00	TSP	670	240	72	129TA6891	129TA6929	129TA6950	129TA6971
23x5	3.75	TSP	610	140	50	129TA6892	-	129TA6951	-
700x15	5.50	TSP	725	185	57	129TA6893	129TA6930	129TA6952	129TA6972
700x15	6.00	TSP	725	185	57,5	129TA6894	-	-	-
750x15	5.50	TSP	745	195	66	129TA6895	-	-	-
750x15	6.00	TSP	745	195	66,8	129TA6896	-	-	-
750x15	6.50	TSP	745	195	67,6	129TA6897	-	129TA6953	-
815x15	7.00	TSP	685	225	63	129TA6898	129TA6931	129TA6954	129TA6973
28x9x15	7.00	TSP	685	225	63	129TA6898	129TA6931	129TA6954	129TA6973
250x15	7.00	TSP	710	220	69	129TA6899	129TA6932	129TA6955	129TA6974
250x15	7.50	TSP	710	220	69	129TA6900	-	-	-
825x15	6.50	TSP	805	210	88	129TA6901	129TA6933	129TA6956	129TA6975
300x15	8.00	TSP	810	250	105	129TA6902	129TA6934	129TA6957	129TA6976
28x12,5x15	9.75	TSP	710	285	89	129TA6903	129TA6935	-	-
355x65x15	9.75	TSP	815	300	135	129TA6904	129TA6936	129TA6958	129TA6977
400x60x15	11.00	TSP	815	330	149	129TA6905	-	-	-
750x16	5.50	TSP	780	170	63	129TA6906	-	-	-
750x16	6.00	TSP	780	170	63	129TA6907	-	-	-
900x20	6.50	TSP	995	255	148	129TA6908	-	-	-
900x20	7.00	TSP	995	255	149	129TA6909	-	-	-
1000x20	7.50	TSP	1020	265	166	129TA6910	-	-	-
1000x20	8.00	TSP	1020	265	166	129TA6911	-	129TA8530	-
1200x20	8.00	TSP	1090	290	215	129TA6912	-	129TA8531	-
1200x20	8.50	TSP	1090	290	215	129TA6913	-	-	-
1200x24	8.50	TSP	1180	280	240	129TA6914	-	-	-
1400x24	10.00	TSP	1290	325	345	129TA6915	-	-	-

PREMIUM SUPER ELASTIC TYRES



INDUSTRIAL PNEUMATIC TYRES



INDUSTRIAL PNEUMATIC TYRES

Industrial pneumatic tyres

- Medium-duty, universal lift truck application
- Deep tread and square shoulders
- Positive traction and extended wear
- Reinforced sidewall and ringuard provides extra protection against damage and puncture
- Non directional tread gives excellent traction forward and backwards

P01



LUG





INDUSTRIAL PNEUMATIC TYRES

Tyre size	Ply rating	Tread pattern	Tyre dia ± 10 mm	Section width ± 5 mm	Approx net weight kg	Set: tyre, tube & flap REF
350x5	6	LUG	280	85	1,7	129TA6978
400x8	8	P01	415	110	4	129TA6979
500x8	10	P01	465	135	7	129TA6980
15x4,5x8	12	P01	380	115	4,8	129TA6981
18x7x8	14	P01	450	165	9	129TA6983
600x9	10	P01	535	148	11	129TA6984
21x8x9	14	P01	520	195	12	129TA6985
650x10	10	P01	590	160	12	129TA6986
650x10	12	P01	590	160	12,2	129TA6987
23x9x10	18	P01	580	225	17	129TA6988
750x10	12	P01	655	220	18	129TA6989
450x12	8	P01	545	115	8	129TA6990
700x12	12	P01	675	175	18,5	129TA6991
700x12	14	P01	675	175	18,5	129TA6992
825x12	12	P01	705	230	21	129TA6993
23x10x12	12	P01	580	240	17	129TA6994
27x10x12	14	P01	665	245	22	129TA6995
23x5	6	P01	590	250	12	129TA6996
550x15	8	P01	665	145	13	129TA6997
600x15	10	P01	695	155	15	129TA6998
700x15	12	P01	770	180	22	129TA6999
750x15	12	P01	800	200	24	129TA7000
815x15	14	P01	685	220	23	129TA7001
28x9x15	14	P01	685	220	23	129TA7001
250x15	16	P01	715	220	24	129TA7002
250x15	20	P01	715	220	25	129TA7003
825x15	14	P01	825	210	32	129TA7004
300x15	20	P01	785	285	39	129TA7005
750x16	12	P01	835	200	45	129TA7008
825x20	14	P01	995	235	38	129TA7010
900x20	14	P01	1015	230	47	129TA7011
1000x20	16	P01	1050	250	61	129TA7012
1100x20	18	P01	1105	295	78	129TA7013
1200x20	18	P01	1120	280	76	129TA7014
1200x20	22	P01	1120	280	80	129TA7015



PREMIUM INDUSTRIAL PNEUMATIC TYRES

PREMIUM INDUSTRIAL PNEUMATIC TYRES

Premium industrial pneumatic tyres

- Heavy-duty tyres with massive blocks on the tread give excellent wear- and tear-resistance
- Reinforced sidewalls provide excellent protection against punctures and lateral damage
- Improved rubber compound results in an extended service life with a minimum of down time

P02



TYRES, RIMS & ACCESSORIES

For all our latest catalogue updates and company info: www.tvh.com



PREMIUM INDUSTRIAL PNEUMATIC TYRES

Tyre size	Ply rating	Tread pattern	Tyre dia ± 10 mm	Section width ± 5 mm	Approx net weight kg	Set: tyre, tube & flap REF
500x8	10	P02	470	137	7,5	129TA8500
16x6x8	16	P02	400	150	9	129TA6982
18x7x8	16	P02	465	170	9,7	129TA8501
600x9	10	P02	545	160	12	129TA8502
21x8x9	14	P02	530	203	13	129TA8503
650x10	10	P02	595	180	13	129TA8504
23x9x10	18	P02	580	230	18	129TA8505
700x12	14	P02	680	190	20	129TA8506
27x10x12	20	P02	680	250	24	129TA8507
550x15	10	P02	670	155	14	129TA8508
700x15	14	P02	750	200	24	129TA8509
750x15	14	P02	800	215	26	129TA8510
815x15	14	P02	700	230	25	129TA8511
28x9x15	14	P02	700	230	25	129TA8511
250x15	20	P02	730	250	28	129TA8512
300x15	20	P02	840	300	45	129TA8513
825x15	14	P02	850	235	35	129TA8514
28x12,5x15	24	P02	710	305	37	129TA7006
32x12,1x15	24	P02	825	305	60	129TA7007
900x16	14	P02	860	225	40	129TA7009
900x20	14	P02	990	260	51	129TA8515
1000x20	18	P02	1070	280	66	129TA8532
1200x20	24	P02	1146	315	96	129TA7016

PREMIUM INDUSTRIAL PNEUMATIC TYRES



SKID STEER AND AERIAL WORK PLATFORMS TUBELESS PNEUMATIC TYRES

SKID STEER TUBELESS PNEUMATIC TYRES

Skid steer and aerial work platforms tubeless pneumatic tyres

- High torque skid steer application
- Maximized traction
- Extra wide tread for better ground-contact and stability
- Self-cleaning tread
- Reinforced rim guard sidewall
- Tubeless*

SKS



SKS 2



* In case of separate tube requirements, please inform us.



SKID STEER AND AERIAL WORK PLATFORMS TUBELESS PNEUMATIC TYRES

Tyre size	Ply rating	Tread pattern	Tyre dia ± 10 mm	Section width ± 5 mm	Approx net weight kg	Set: tubeless tyre REF
570x12	8	SKS	560	140	7	129TA7017
23x8,5x12	6	SKS	555	215	10,5	129TA7018
27x8,5x15	6	SKS	655	215	14	129TA7019
27x10,5x15	8	SKS	655	265	16	129TA7020
31x15,5x15	8	SKS	780	390	37	129TA7021
10x16,5	8	SKS	780	260	22	129TA7022
10x16,5	10	SKS 2	780	260	30	129TA7023
12x16,5	10	SKS	830	310	27	129TA7025
12x16,5	12	SKS	830	310	27,5	129TA7026
14x17,5	14	SKS	920	365	54	129TA7027
240/55D17,5	12	SKS	710	240	*	129TA7028
15x19,5	14	SKS	990	390	70	129TA7029
445/55D19,5	16	SKS	1000	440	80	129TA7030
355/55D625	16	SKS	1015	355	50	129TA7031
15x625	16	SKS	1120	380	50	141TA3243
18x625	16	SKS	1080	455	*	129TA7032
445/50D710	18	SKS	1155	440	96	129TA7033
9 - 14,5	12	LIJN	711	241	15	128TA3440

SKID STEER TUBELESS PNEUMATIC TYRES

* In case of separate tube requirements, please inform us.



TYRES, RIMS & ACCESSORIES

For all our latest catalogue updates and company info: www.tvh.com



VARIOUS OTR, AGRICULTURAL AND EM PNEUMATIC TYRES

VARIOUS OTR, AGRICULTURAL AND EM PNEUMATIC TYRES

RIB



IMP1



EM2



IMP3



AGRI R1



AGRI R4



Grader G2



EM3 (A)



E4B



EM4



DUN PG7



DUN T37



TYRES, RIMS & ACCESSORIES

For all our latest catalogue updates and company info: www.tvh.com



VARIOUS OTR, AGRICULTURAL AND EM PNEUMATIC TYRES

Tyre size	Ply rating	Tread pattern	Tyre dia ± 10 mm	Section width ± 5 mm	Approx net weight kg	REF	Remarks
400x8	2	RIB	400	100	1,5	129TA7034	TT - with tube
11L15	8	IMP1	770	270	24	129TA7035	TL - tubeless
11L16	8	IMP1	790	275	26	129TA7036	TL - tubeless
10,0/75x15,3	10	AGRI R1	770	250	20	129TA7037	TL - tubeless
11,5/80x15,3	10	AGRI R1	855	280	27,5	129TA7038	TL - tubeless
750x16	6	AGRI R1	805	205	19	129TA7039	TT - with tube
10,5/80x18	10	IMP3	910	270	31	129TA7040	TL - tubeless
12,5/80x18	12	IMP3	990	340	42	129TA7041	TL - tubeless
12,5x18	12	AGRI R4	1000	350	43	129TA7042	TL - tubeless
15,5/55x18	14	DUN PG7	880	360	47	129TA7043	TL - tubeless
18x19,5	16	AGRI R1	1130	490	64	129TA7044	TL - tubeless
405/70x20	14	AGRI R1	1070	405	70	129TA7045	TL - tubeless
16/70x20	14	AGRI R1	1070	405	70	129TA7046	TL - tubeless
10,5x20	10	IMP3	970	290	39	129TA7047	TL - tubeless
12,5x20	12	IMP3	1070	350	52	129TA7048	TL - tubeless
12,5x20	12	EM2	1070	350	52	129TA7049	TT - with tube
14,5x20	12	IMP3	1125	380	60	129TA7050	TL - tubeless
385/65x22,5	20	Grader	1100	375	95	129TA7051	TL - tubeless
18x22,5	16	AGRI R1	1200	490	85	129TA7052	TL - tubeless
11,2x24	8	AGRI R1	1090	275	37,5	129TA7053	TT - with tube
12,4x24	8	AGRI R1	1150	305	45	129TA7054	TT - with tube
13,6x24	8	AGRI R1	1200	335	59	129TA7055	TT - with tube
14,9x24	8	AGRI R1	1255	370	75	129TA7056	TT - with tube
16,9x24	12	AGRI R4	1280	420	83	129TA7057	TL - tubeless
17,5x24	10	AGRI R4	1230	420	73	129TA7058	TL - tubeless
19,5x24	12	AGRI R4	1325	490	91	129TA7059	TL - tubeless
405/70x24	14	AGRI R1	1165	400	78	129TA7060	TL - tubeless
400/80-24	153/156B	DUN T37	1267	402	59	141TA4889	TL-Tubeless
440/80-24	158B	DUN T37	1336	441	85	141TA4890	TL-Tubeless
460/70-24	152A8	AGRI R1	1252	462	91	141TA4891	TL-Tubeless
15,5/80x24	12	AGRI R1	1250	385	73	129TA7061	TL - tubeless
1200x24	20	EM3	1125	315	65	129TA7062	TT - with tube
1300x24	12	Grader	1278	333	68	129TA7063	TL - tubeless
1400x24	12	Grader	1350	360	80	129TA7064	TL - tubeless
1400x24	24	EM3	1370	375	195	129TA7065	TT - with tube
1400x24	28	EM3	1370	375	205	129TA7066	TT - with tube
15,5x25	12	EM3	1275	395	100	129TA7067	TL - tubeless
17,5x25	16	EM3	1350	445	122	129TA7068	TL - tubeless
20,5x25	20	EM3	1490	520	176	129TA7069	TL - tubeless
23,5x25	20	EM3	1615	595	242	129TA7070	TL - tubeless
23,5x25	20	EM3	1615	595	242	141TA3244	TT - with tube
26,5x25	28	EM3	1700	650	381	129TA7071	TL - tubeless
29,5x25	28	EM3	1825	700	450	129TA7072	TL - tubeless
1600x25	32	EM3	1490	430	178	129TA7073	TL - tubeless
1800x25	40	EM3A	1615	495	302	129TA7074	TL - tubeless
1800x25	40	EM4B	1675	495	390	131TA2408	TL - tubeless
18,4x26	10	AGRI R1	1440	460	108	129TA7075	TL - tubeless
14,9x28	8	AGRI R1	1355	370	61	129TA7076	TT - tyre without tube
16,9x28	10	AGRI R1	1335	430	81	129TA7077	TT - tyre without tube
29,5x29	28	EM3	1825	700	480	129TA7078	TL - tubeless
1800x33	36	E4B	1875	495	440	129TA7079	TL - tubeless

VARIOUS OTR, AGRICULTURAL AND EM PNEUMATIC TYRES



TYRES, RIMS & ACCESSORIES

For all our latest catalogue updates and company info: www.tvh.com

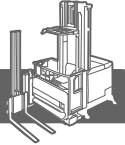

PRESS-ON TYRES: CILINDRICAL AND CONICAL BASE

PRESS-ON TYRES: CILINDRICAL BASE

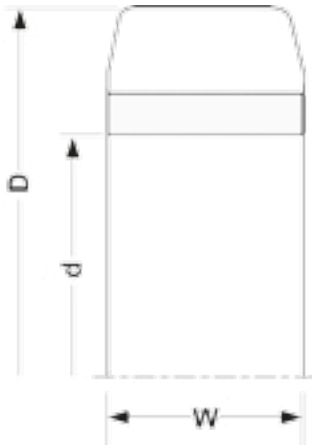

Smooth



Urethane

Smooth - black



Rubber

Smooth - non-marking



Rubber

TR



Urethane

TR - black



Rubber

TR - non-marking



Rubber

PRESS-ON TYRES: CONICAL BASE

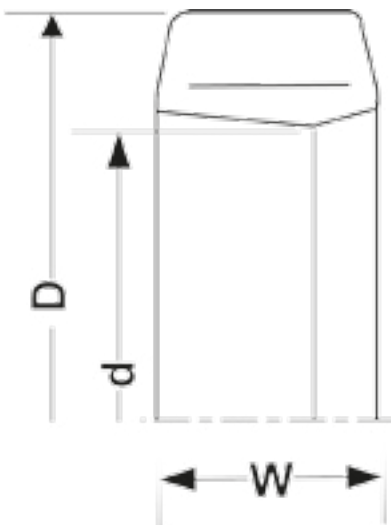

Asymmetric

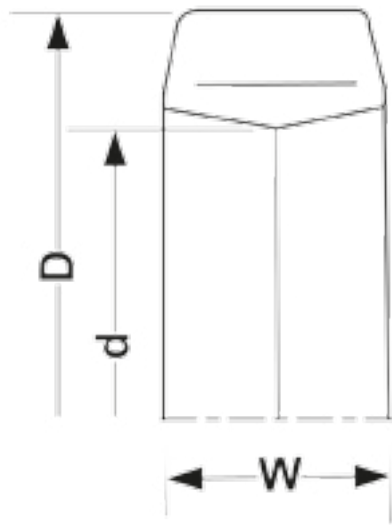

Symmetric

Smooth



Urethane

Smooth - black









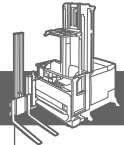

Rubber

TYRES, RIMS & ACCESSORIES

For all our latest catalogue updates and company info: www.tvh.com



PRESS-ON TYRES: SIZES

									
		Rubber cylindrical base				Rubber conical base	Urethane cylindrical base		Urethane conical base
Metric size DxWxd mm	Imperial size DxWxd inch	REF smooth black	REF smooth non- marking	REF TR black	REF TR non- marking	REF smooth black	REF smooth	REF TR	REF smooth
125x50x75		111TA1393	-	-	-	111TA1675	111TA1720	-	129TA7529
204x76x75		-	-	-	-	-	111TA1370	-	-
140x115x80		111TA1394	-	-	-	-	111TA7359	-	-
120x40x84		-	-	-	-	-	-	-	-
150x100x185		-	-	-	-	-	129TA7360	-	-
150x50x100		111TA1395	-	-	-	111TA1676	129TA7361	-	111TA1833
160x50x100		111TA1398	-	-	-	111TA1677	129TA7362	-	-
160x60x100		-	-	-	-	-	111TA1725	-	-
150x75x100		111TA1396	-	-	-	-	129TA7363	-	-
170x75x100		139TA9599	-	-	-	-	-	-	-
180x75x100		-	-	-	-	111TA1678	129TA7364	-	-
200x75x100		129TA7084	129TA7176	-	-	129TA7333	111TA1727	-	-
150x130x100		129TA7085	-	-	-	-	129TA7365	-	-
165x64x101	6,25x2,5x4	-	-	-	-	-	129TA7366	-	-
216x102x102	8,5x4x4	129TA7086	129TA7177	129TA7238	-	-	129TA7367	-	-
200x85x105		111TA1404	129TA7178	129TA7239	-	129TA7334	129TA7368	-	111TA1834
180x100x105		-	-	-	-	-	129TA7369	-	129TA7530
200x130x105		129TA7087	-	-	-	-	129TA7370	-	-
180x75x110		-	-	-	-	-	129TA7371	-	-
180x50x120		129TA7088	-	-	-	129TA7335	129TA7372	-	129TA7531
180x75x120		111TA1400	-	-	-	-	129TA7373	-	-
200x75x120		-	-	-	-	-	111TA1734	-	-
230x75x120		111TA1411	-	-	-	-	129TA7374	-	-
204x76x120		129TA7089	-	-	-	-	111TA1351	-	-
200x80x120		-	-	-	-	-	129TA7375	-	-
180x100x120		-	-	-	-	-	111TA1731	-	-
200x105x120		-	-	-	-	-	111TA1736	-	-
267x152x127	10,5x6x5	111TA1460	-	-	-	-	-	-	-
190x51x127	7,5x2x5	-	-	-	-	-	111TA1739	-	-
229x89x127	9x3,5x5	129TA7090	-	-	-	-	129TA7376	-	-
230x127x127	9x5x5	111TA1415	129TA7336	129TA7240	-	-	-	-	-
200x50x140		129TA7091	-	-	-	129TA7337	129TA7377	-	129TA7532
200x70x140		-	-	-	-	-	129TA7378	-	-
250x75x140		111TA1419	-	-	-	129TA7338	-	-	-
250x90x140		-	-	-	-	-	111TA1465	-	-
210x100x140		-	-	-	-	-	129TA7379	-	-
230x100x140		-	-	-	-	-	129TA7380	129TA7519	-
250x100x140		129TA7092	-	-	-	-	-	-	-

PRESS-ON TYRES: CILINDRICAL AND CONICAL BASE



TYRES, RIMS & ACCESSORIES

For all our latest catalogue updates and company info: www.tvh.com

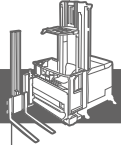

PRESS-ON TYRES: CILINDRICAL AND CONICAL BASE

PRESS-ON TYRES: SIZES

Metric size DxWxd mm	Imperial size DxWxd inch	Rubber cilindrical base				Rubber conical base	Urethane cilindrical base		Urethane conical base
		REF smooth black	REF smooth non- marking	REF TR black	REF TR non- marking	REF smooth black	REF smooth	REF TR	REF smooth
250x130x140		129TA7093	129TA7339	111TA1428	-	-	129TA7381	-	-
235x75x145		-	-	-	-	-	129TA7382	-	-
230x85x145		-	-	-	-	-	129TA7383	-	-
254x90x145		129TA7094	129TA7179	129TA7241	-	-	129TA7384	-	-
254x120x145		111TA1297	-	-	-	-	129TA7385	-	-
250x135x145		-	-	-	-	-	129TA7386	-	-
255x135x145		111TA1238	-	-	-	-	-	-	-
280x135x145		111TA1307	-	-	-	-	129TA7387	-	-
280x152x146		-	-	129TA7242	-	-	111TA1359	-	-
200x60x150		-	-	-	-	-	129TA7388	-	-
250x90x150		129TA7095	129TA7180	-	-	-	-	-	-
200x100x150		-	-	-	-	-	129TA7389	-	-
254x102x158	10x4x6,25	129TA7096	129TA7181	-	-	-	129TA7390	129TA7520	-
254x120x158		111TA1275	-	-	-	-	-	-	-
254x127x158	10x5x6,25	129TA7097	129TA7182	111TA1437	-	-	129TA7391	-	-
254x76x158	10x3x6,25	111TA1429	-	-	-	-	129TA7392	-	-
254x89x158	10x3,5x6,25	-	-	-	-	-	129TA7393	-	-
254x152x158	10x6x6,25	129TA7098	-	-	-	-	111TA1374	-	-
254x178x158	10x7x6,25	111TA1443	-	-	-	-	-	-	-
220x60x160		129TA7099	-	-	-	-	129TA7394	-	-
265x160x160		129TA7100	-	-	-	-	129TA7395	-	-
280x160x160		-	-	-	-	129TA7340	-	-	-
254x76x165	10x3x6,5	111TA1430	-	-	-	-	111TA1755	129TA7521	-
203x102x165	8x4x6,5	-	-	-	-	-	129TA7396	-	-
254x102x165	10x4x6,5	129TA7101	129TA7183	129TA7243	129TA7291	-	129TA7397	-	-
267x102x165	10,5x4x6,5	-	-	-	-	-	129TA7398	-	-
254x114x165	10x4,5x6,5	-	-	-	-	-	129TA7399	-	-
254x120x165	10x4,75x6,5	129TA7102	-	-	-	-	129TA7400	-	-
254x127x165	10x5x6,5	129TA7103	129TA7184	129TA7244	129TA7292	-	129TA7401	-	-
267x127x165	10,5x5x6,5	111TA1458	129TA7185	129TA7245	129TA7293	-	129TA7402	-	-
305x135x165		111TA1379	-	-	-	-	111TA1378	-	-
286x146x165		111TA1279	-	-	-	-	129TA7403	-	-
305x146x165		129TA7104	-	-	-	-	-	-	-
254x152x165	10x6x6,5	129TA7105	-	-	-	-	129TA7404	-	-
267x152x165	10,5x6x6,5	111TA1461	129TA7186	-	-	-	129TA7405	-	-
285x152x165		-	-	-	-	-	111TA1377	-	-
305x152x165	12x6x6,5	129TA7106	129TA7187	-	-	-	129TA7406	-	-
220x70x168		-	-	-	-	-	-	-	129TA7533

TYRES, RIMS & ACCESSORIES

For all our latest catalogue updates and company info: www.tvh.com

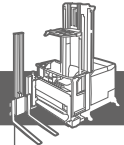

PRESS-ON TYRES: SIZES

Metric size DxWxd mm	Imperial size DxWxd inch	Rubber cilindrical base				Rubber conical base	Urethane cilindrical base		Urethane conical base
		REF smooth black	REF smooth non- marking	REF TR black	REF TR non- marking	REF smooth black	REF smooth	REF TR	REF smooth
240x114x168		-	-	-	-	-	-	-	129TA7534
254x120x169		111TA1295	-	-	-	-	-	-	111TA1296
230x50x170		111TA1410	-	-	-	-	-	-	129TA7535
250x60x170		-	-	-	-	129TA7341	-	-	129TA7536
260x60x170		-	-	-	-	-	129TA7407	-	129TA7537
230x75x170		129TA7107	129TA7188	129TA7246	129TA7294	-	111TA1764	129TA7522	-
250x80x170		129TA7108	129TA7189	129TA7247	129TA7295	-	129TA7408	129TA7523	-
230x85x170		129TA7109	129TA7190	129TA7248	-	-	129TA7409	129TA7524	-
260x85x170		111TA1448	129TA7191	129TA7249	129TA7296	-	111TA1768	129TA7525	-
300x85x170		129TA7110	-	-	-	-	-	-	-
250x90x170		111TA1423	129TA7192	129TA7250	-	-	-	-	-
250x100x170		-	-	-	-	-	129TA7410	129TA7526	-
250x105x170		111TA1426	129TA7193	129TA7251	129TA7297	-	129TA7411	-	-
260x105x170		111TA1451	-	111TA1450	-	-	129TA7412	129TA7527	-
270x105x170		-	-	-	-	129TA7342	129TA7413	-	-
260x130x170		111TA1453	-	-	-	-	111TA1772	-	-
305x152x170		111TA1243	-	-	-	-	-	-	-
230x85x178		-	-	-	-	-	129TA7414	-	-
254x102x178	10x4x7	-	-	-	-	-	111TA1774	-	-
254x100x180		-	-	-	-	-	129TA7415	-	-
254x114x180		-	-	-	-	-	129TA7416	-	-
267x114x180		-	-	-	-	-	115ta5846	-	-
267x135x180		-	-	-	-	-	129TA7417	-	-
315x145x180		111TA1314	129TA7194	129TA7253	-	-	129TA7418	-	-
330x145x180		129TA7111	136TA1300	-	-	-	-	-	-
235x75x185		-	-	-	-	-	129TA7419	-	-
250x80x185		-	-	-	-	-	111TA1776	-	-
235x85x185		-	-	-	-	-	129TA7420	-	-
290x105x185		111TA1472	-	129TA7254	-	-	111TA1778	111TA1779	-
155x100x187		-	-	-	-	-	129TA7421	-	-
250x50x190		129TA7112	-	-	-	111TA1684	129TA7422	-	129TA7538
250x60x190		111TA1418	129TA7195	-	-	-	111TA1780	-	129TA7539
280x60x190		111TA1464	-	129TA7255	-	-	129TA7423	-	-
250x80x190		-	-	-	-	-	129TA7424	129TA7528	-
250x85x190		111TA1421	129TA7196	129TA7256	-	-	129TA7425	-	-
250x100x190		129TA7113	-	-	-	-	-	-	-
254x100x190		-	-	-	-	-	129TA7426	-	-
250x105x190		-	-	-	-	-	129TA7427	-	-

PRESS-ON TYRES: CILINDRICAL AND CONICAL BASE



TYRES, RIMS & ACCESSORIES

For all our latest catalogue updates and company info: www.tvh.com

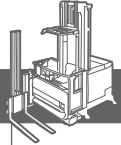

PRESS-ON TYRES: CILINDRICAL AND CONICAL BASE

PRESS-ON TYRES: SIZES







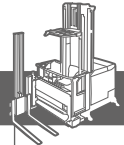

Metric size DxWxd mm	Imperial size DxWxd inch	Rubber cilindrical base				Rubber conical base	Urethane cilindrical base		Urethane conical base
		REF smooth black	REF smooth non- marking	REF TR black	REF TR non- marking	REF smooth black	REF smooth	REF TR	REF smooth
250x120x190		-	-	-	-	-	129TA7428	-	-
254x120x190		-	-	-	-	-	129TA7429	-	-
330x145x193		111TA1381	-	129TA7257	-	-	111TA1286	-	-
260x88x195		-	-	-	-	-	111TA1783	-	-
320x130x199		111TA1246	-	-	-	-	129TA7430	-	-
330x148x199		111TA1501	-	-	-	-	-	-	-
320x150x199		-	-	-	-	-	129TA7431	-	-
310x75x200		-	-	-	-	111TA1697	-	-	129TA7540
285x100x200		-	-	-	-	129TA7343	111TA1784	-	111TA1839
310x120x200		-	-	-	-	129TA7344	129TA7432	-	129TA7541
310x140x200		-	-	-	-	129TA7345	-	-	-
254x76x203	10x3x8	-	-	129TA7258	-	-	105TA4626	-	-
267x76x203	10,5x3x8	-	-	-	-	-	111TA1788	-	-
267x89x203	10,5x3,5x8	-	-	-	-	-	129TA7433	-	-
330x89x203	13x3,5x8	111TA1503	-	129TA7259	129TA7298	-	111TA1791	-	-
300x90x203		129TA7114	129TA7197	129TA7260	-	-	129TA7434	-	-
285x100x203		129TA7115	-	129TA7261	-	-	-	-	-
300x100x203		129TA7116	129TA7198	111TA1481	-	129TA7346	129TA7435	-	129TA7542
267x102x203	10,5x4x8	-	-	-	-	-	129TA7436	-	-
305x102x203	12x4x8	129TA7117	129TA7199	-	-	-	129TA7437	-	-
267x114x203	10,5x4,5x8	-	-	-	-	-	129TA7438	-	-
305x114x203	12x4,5x8	111TA1488	129TA7200	111TA1489	129TA7299	-	129TA7439	-	-
330x114x203	13x4,5x8	129TA7118	129TA7201	129TA7262	-	-	129TA7440	-	-
343x114x203	13,5x4,5x8	-	-	129TA7263	129TA7300	-	129TA7441	-	-
356x114x203	14x4,5x8	111TA1516	129TA7202	129TA7264	129TA7301	-	129TA7442	-	-
310x120x203		-	-	-	-	-	111TA1794	-	-
305x127x203	12x5x8	111TA1491	129TA7203	129TA7265	129TA7302	-	129TA7443	-	-
330x127x203	13x5x8	129TA7119	129TA7204	129TA7266	129TA7303	-	111TA1795	-	-
356x127x203	14x5x8	-	-	-	-	-	129TA7444	-	-
313x130x203		129TA7120	-	-	-	129TA7347	129TA7445	111TA1796	-
305x140x203	12x5,5x8	-	-	-	-	-	129TA7446	-	-
330x140x203	13x5,5x8	-	-	129TA7267	-	-	129TA7447	-	-
343x140x203	13,5x5,5x8	111TA1511	129TA7205	129TA7268	129TA7304	129TA7348	129TA7448	-	-
305x152x203		111TA1244	-	-	-	-	129TA7449	-	-
330x152x203	13x6x8	-	-	-	-	-	129TA7450	-	-
343x152x203	13,5x6x8	129TA7121	-	-	-	-	129TA7451	-	-
343x165x203	13,5x6,5x8	129TA7122	-	-	-	-	-	-	-
280x50x220		129TA7123	-	-	-	-	129TA7452	-	-

TYRES, RIMS & ACCESSORIES

For all our latest catalogue updates and company info: www.tvh.com



PRESS-ON TYRES: SIZES

									
		Rubber cylindrical base				Rubber conical base	Urethane cylindrical base		Urethane conical base
Metric size DxWxd mm	Imperial size DxWxd inch	REF smooth black	REF smooth non- marking	REF TR black	REF TR non- marking	REF smooth black	REF smooth	REF TR	REF smooth
285x50x220		-	-	-	-	-	129TA7453	-	-
310x60x220		129TA7124	-	-	-	-	129TA7454	-	-
285x75x220		129TA7125	129TA7206	-	-	111TA1692	111TA1799	-	111TA1841
285x100x220		-	-	-	-	-	129TA7455	-	-
380x110x220		129TA7126	-	-	-	-	-	-	-
310x120x220		129TA7127	-	-	-	-	129TA7456	-	-
330x120x220		129TA7128	-	-	-	-	129TA7457	-	-
380x152x220		-	-	-	-	-	111TA1255	-	-
380x160x220		129TA7129	-	-	-	-	-	-	-
360x180x220		129TA7130	129TA7207	-	-	-	111TA1252	-	-
343x114x225		-	-	-	-	-	111TA1802	111TA1803	129TA7543
343x140x225		-	-	-	-	-	-	-	129TA7544
285x100x228		-	-	-	-	-	129TA7545	-	-
305x127x229	12x5x9	-	-	-	-	-	129TA7546	-	-
300x140x230		-	-	-	-	-	129TA7459	-	-
300x50x240		-	-	-	-	-	129TA7460	-	-
300x75x240		129TA7131	-	-	-	-	129TA7461	-	-
310x105x240		-	-	-	-	-	129TA7462	-	-
330x140x241	13x5,5x9,5	-	-	-	-	-	129TA7463	-	-
345x115x245		-	-	-	-	-	105TA4632	-	-
345x140x245		-	-	-	-	-	129TA7464	-	-
380x145x246		129TA7132	-	-	-	-	111TA1319	-	-
380x165x246		129TA7133	-	-	-	-	129TA7465	-	-
313x85x247		129TA7134	-	-	-	-	129TA7466	-	-
310x120x248		-	-	-	-	-	129TA7467	-	-
405x160x250		-	-	-	-	129TA7349	-	-	-
305x76x254	12x3x10	-	-	-	-	-	111TA1807	-	-
318x76x254	12,5x3x10	-	-	-	-	-	129TA7468	-	-
318x90x254	12,5x3,5x10	-	-	-	-	-	129TA7469	-	-
330x90x254	13x3,5x10	-	-	-	-	-	129TA7470	-	-
356x102x254	14x4x10	111TA1514	129TA7208	-	-	-	-	-	-
330x114x254	13x4,5x10	-	-	-	-	-	111TA1809	-	-
330x127x254	13x5x10	-	-	-	-	-	111TA1810	-	-
256x127x254	14x5x10	129TA7135	129TA7209	129TA7269	129TA7305	-	129TA7471	-	-
394x127x254	15,5x5x10	129TA7136	129TA7136	129TA7270	129TA7306	-	129TA7472	-	-
343x140x254	13,5x5,5x10	129TA7137	-	-	-	-	129TA7473	-	-
330x152x254	13x6x10	-	-	-	-	-	129TA7474	-	-
343x152x254	13,5x6x10	-	-	-	-	-	129TA7475	-	-

PRESS-ON TYRES: CILINDRICAL AND CONICAL BASE



TYRES, RIMS & ACCESSORIES

For all our latest catalogue updates and company info: www.tvh.com

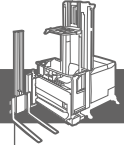

PRESS-ON TYRES: SIZES

PRESS-ON TYRES: CILINDRICAL AND CONICAL BASE

Metric size DxWxd mm	Imperial size DxWxd inch	Rubber cilindrical base				Rubber conical base	Urethane cilindrical base		Urethane conical base
		REF smooth black	REF smooth non- marking	REF TR black	REF TR non- marking	REF smooth black	REF smooth	REF TR	REF smooth
385x52x254		-	-	-	-	-	129TA7476	-	-
394x152x254	15,5x6x10	129TA7138	129TA7210	-	-	-	111TA1384	-	-
343x152x267	13,5x6x10,5	-	-	-	-	-	129TA7477	-	-
406x127x267	16x5x10,5	129TA7139	129TA7211	129TA7271	129TA7307	129TA7350	111TA1811	-	111TA1844
330x152x267	13x6x10,5	-	-	-	-	-	111TA1812	-	-
406x152x267	16x6x10,5	129TA7140	129TA7212	129TA7272	129TA7308	129TA7351	129TA7478	-	129TA7547
406x178x267	16x7x10,5	129TA7141	129TA7213	111TA1546	129TA7309	129TA7352	129TA7479	-	111TA1845
360x60x270		129TA7142	-	-	-	-	-	-	-
330x90x270		-	-	-	-	-	111TA1813	-	-
350x100x270		-	-	-	-	-	129TA7481	-	-
350x110x270		-	-	-	-	-	111TA1815	-	-
350x127x270		-	-	-	-	-	129TA7482	-	-
343x140x270		-	-	-	-	-	111TA1814	-	-
350x140x270		-	-	-	-	-	111TA1816	-	-
350x90x280		111TA1513	-	-	-	-	111TA1817	-	-
350x100x280		-	-	-	-	-	129TA7483	-	-
350x115x280		-	-	-	-	-	129TA7484	-	-
360x152x285		-	-	-	-	-	111TA1818	-	-
356x127x286	14x5x11,25	-	-	-	-	-	129TA7485	-	-
381x127x286	15x5x11,25	129TA7145	129TA7214	111TA1526	129TA7310	-	129TA7486	-	-
413x127x286	16,25x5x11,25	129TA7146	129TA7215	129TA7273	129TA7311	-	129TA7487	-	-
381x152x286	15x6x11,25	129TA7147	-	129TA7274	129TA7312	-	111TA1822	-	-
413x152x286	16,25x6x11,25	129TA7148	129TA7216	111TA1550	129TA7313	-	129TA7488	-	-
381x178x286	15x7x11,25	129TA7149	-	-	-	-	111TA1821	-	-
413x178x286	16,25x7x11,25	129TA7150	129TA7217	129TA7275	129TA7314	-	129TA7489	-	-
356x203x286	14x8x11,25	-	-	-	-	-	129TA7490	-	-
381x203x286	15x8x11,25	-	-	-	-	-	129TA7491	-	-
405x130x290		-	-	-	-	-	111TA1824	-	-
405x145x290		-	-	-	-	-	111TA1825	-	-
381x152x298	15x6x11,75	-	-	-	-	-	129TA7492	-	-
405x65x305		129TA7151	-	-	-	-	129TA7493	-	-
415x75x305		129TA7152	-	-	-	-	129TA7494	-	-
405x80x305		-	-	-	-	-	129TA7495	-	-
415x90x305		129TA7153	-	-	-	129TA7354	111TA1827	-	-
415x100x305		129TA7154	-	-	-	129TA7355	-	-	-
405x130x305		111TA1536	-	-	-	-	111TA1826	-	-
425x150x305		129TA7155	129TA7218	-	-	-	129TA7496	-	-
406x178x305	16x7x12	-	-	-	-	-	111TA1828	-	-

TYRES, RIMS & ACCESSORIES

For all our latest catalogue updates and company info: www.tvh.com

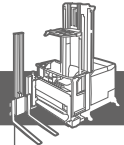

PRESS-ON TYRES: SIZES

Metric size DxWxd mm	Imperial size DxWxd inch	Rubber cilindrical base				Rubber conical base	Urethane cilindrical base		Urethane conical base
		REF smooth black	REF smooth non- marking	REF TR black	REF TR non- marking	REF smooth black	REF smooth	REF TR	REF smooth
405x260x305		111TA1538	-	-	-	-	-	-	-
425x260x305		129TA7156	-	-	-	-	-	-	-
450x300x305		129TA7157	-	-	-	-	-	-	-
406x89x308	16x3,5x12,125	129TA7158	129TA7219	-	-	-	-	-	-
406x114x308	16x4,5x12,125	129TA7159	-	-	-	-	129TA7498	-	-
406x102x308	16x4x12,125	-	-	-	-	-	129TA7497	-	-
432x114x308	17x4,5x12,125	129TA7160	-	129TA7276	-	-	-	-	-
432x127x308	17x5x12,125	111TA1565	-	129TA7277	129TA7315	-	-	-	-
457x127x308	18x5x12,125	129TA7161	129TA7220	111TA1574	129TA7316	129TA7356	129TA7499	-	-
381x152x308	15x6x12,125	-	-	-	-	-	111TA1829	-	-
432x152x308	17x6x12,125	111TA1566	129TA7221	129TA7278	129TA7317	-	129TA7500	-	-
457x152x308	18x6x12,125	111TA1577	129TA7222	129TA7279	129TA7318	111TA1716	129TA7501	-	-
457x178x308	18x7x12,125	111TA1579	129TA7223	111TA1578	129TA7319	129TA7357	129TA7502	-	-
457x203x308	18x8x12,125	129TA7162	129TA7224	111TA1580	129TA7320	-	129TA7503	-	-
457x229x308	18x9x12,125	111TA1584	129TA7225	111TA1583	129TA7321	-	129TA7504	-	-
533x229x330	21x9x13	-	-	-	-	129TA7358	-	-	-
457x203x356	18x8x14	129TA7163	-	-	-	-	-	-	-
457x229x356	18x9x14	129TA7164	-	-	-	-	-	-	-
500x140x370		-	-	-	-	-	129TA7505	-	-
533x127x381	21x5x15	-	-	129TA7280	129TA7322	-	-	-	-
533x152x381	21x6x15	-	-	129TA7281	129TA7323	-	-	-	-
533x178x381	21x7x15	129TA7165	129TA7226	111TA1610	129TA7324	-	129TA7506	-	-
533x203x381	21x8x15	129TA7166	129TA7227	129TA7282	129TA7325	-	129TA7507	-	-
533x229x381	21x9x15	-	-	129TA7283	129TA7326	-	129TA7508	-	-
559x152x406	22x6x16	-	129TA7228	129TA7284	-	-	111TA1830	-	-
559x178x406	22x7x16	129TA7167	129TA7229	129TA7285	129TA7327	-	129TA7509	-	-
559x203x406	22x8x16	111TA1630	129TA7230	129TA7286	129TA7328	-	129TA7510	-	-
559x229x406	22x9x16	129TA7168	129TA7231	129TA7287	129TA7329	-	129TA7511	-	-
559x254x406	22x10x16	129TA7169	129TA7232	129TA7288	129TA7330	-	129TA7512	-	-
559x305x406	22x12x16	111TA1634	129TA7233	111TA1635	129TA7331	-	129TA7513	-	-
559x356x406	22x14x16	129TA7170	-	-	-	-	129TA7514	-	-
559x406x406	22x16x16	129TA7171	-	-	-	-	-	-	-
645x300x410		111TA1648	129TA7234	-	-	-	129TA7515	-	-
660x178x508	26x7x20	-	-	129TA7289	-	-	-	-	-
711x254x559	28x10x22	129TA7172	-	-	-	-	129TA7516	-	-
711x305x559	28x12x22	129TA7173	129TA7235	129TA7290	129TA7332	-	-	-	-
711x356x559	28x14x22	129TA7174	129TA7236	-	-	-	129TA7517	-	-
711x406x559	28x16x22	129TA7175	129TA7237	-	-	-	129TA7518	-	-

PRESS-ON TYRES: CILINDRICAL AND CONICAL BASE



TYRES, RIMS & ACCESSORIES

For all our latest catalogue updates and company info: www.tvh.com

MOULD-ON WHEELS

MOULD-ON WHEELS USED FOR GENIE



REF 128TA3436

- Wheel 12x4,5
- Non-marking rubber
- Conical centerhole with K-way
- Used on GS1530, GS1930



REF 128TA3437

- Wheel 15x5
- Non-marking rubber
- Conical centerhole with K-way
- Used on GS2032, GS2046, GS2646



REF 128TA3434

- Wheel 22x7
- Non-marking rubber
- 9 stud holes
- Used on Z30/20N, Z34/22N, Z40/23
- Non-steer end



REF 128TA3435

- Wheel 22x7
- Non-marking rubber
- 8 stud holes
- Used on Z30/20N, Z34/22N, Z40/23
- Steer end



REF 128TA3433

- Wheel 22x7
- Black rubber
- 9 stud holes
- Used on Z30/20N, Z34/22N, Z40/23
- Non-steer end



REF 128TA3432

- Wheel 22x7
- Black rubber
- 8 stud holes
- Used on Z30/20N, Z34/22N, Z40/23
- Steer end

MOULD-ON WHEELS USED FOR JLG



REF 139TA5222

- Wheel 406x105
- Non-marking rubber
- 5 stud holes
- Used on 2030ES, 2630ES, 2646ES, 3246ES



REF 126TA5139

- Wheel 323x96
- Non-marking rubber
- 5 stud holes
- Used on 1930ES



REF 126TA5939

- Wheel 14x4,5
- Non-marking rubber
- 5 stud holes
- Used on 1532E3, 1932E3



REF 141TA4893

- Wheel 14x4,5
- Black Rubber
- 5 stud holes
- Used on 1532E3, 1932E3



REF 129TA9006

- Wheel 16x5
- Non-marking rubber
- 5 stud holes
- Used on 2030ES, 2658ES, ...



REF 126TA5938

- Wheel 16x5
- Black rubber
- 5 stud holes
- Used on 2030ES, 2658ES, ...



MOULD-ON WHEELS USED FOR HAULOTTE



REF [138TA7515](#)

- Wheel 12,5x4,25
- Non-marking rubber
- Centerhole with K-way
- Used on Optimum 6 / 8



REF [138TA7514](#)

- Wheel 381x127
- Non-marking rubber
- Centerhole with K-way
- Used on Compact 8 / 8W / 10 / 10N / 10RTE / 12

MOULD-ON WHEELS USED FOR UPRIGHT



REF [141TA4895](#)

- Wheel 305x100 - 255
- Non-marking rubber
- Conical centerhole with K-way
- Used on Upright



REF [141TA4894](#)

- Wheel 305x100 - 255
- Non-marking rubber
- Centerhole with tapered roller bearing
- Used on Upright



REF [141TA4896](#)

- Wheel 305x76 - 254
- Non-marking rubber
- Centerhole with bushing
- Used on Upright

MOULD-ON WHEELS USED FOR SKYJACK



REF [141TA4897](#)

- Wheel 16x5
- Non-marking rubber
- 5 stud holes
- Used on 3320, 3226, 4620, 4626, 4632
- Rear wheel with brake disk



REF [129TA9043](#)

- Wheel 16x5
- Non-marking rubber
- 5 stud holes
- Used on 3320, 3226, 4620, 4626, 4632
- Front wheel without brake disk



SPLIT RIM OR DIVIDED RIM

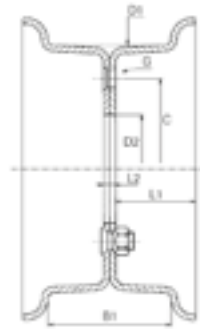

Structure:

- Steel plated, rim consisting out of 2 halves, supplied along with the existing bolts, nuts and washers.
- Possibility for other dimensions, ask your contact at TVH. (also see "rim technical fill out form")

Rim width B1	Rim diameter D1	Tyre size	Centre-hole D2 (mm)	Pitch-circle C (mm)	No. of holes G	Ø of studholes	Flange-position	Used for	REF
2.50	4	4.00-4	52	68	5	8,0	Half	Komatsu - Pimespo - OM	129TA7548
3.00 D	8	4.00-8	85	130	5	19,0	Half	Clark	129TA7549
		5.00-8	110	140	5	18,5	Half	Hyster	129TA7550
		125/75-8	86	114	6	15,0	Half	Toyota	107TA5381
		15x4.5-8	100	125	6	16,0	Half	Various	107TA5382
4.33 R	8		110	148	6	15,0	Half	Various	107TA5380
		16x6-8	95	135	5	17,5	124	Various	129TA7551
		150/75-8	110	145	5	18,5	Half	Hyster	129TA7552
		18x7-8	110	147	5	17,5	122	Various	107TA5384
		180/70-8	90	130	6	17,5	89	Various	107TA5385
			96	136	6	17,5	121	TCM	129TA7553
			100	140	6	17,5	50	Komatsu	107TA5383
4.00 E	9	6.00-9	105	142	6	18,0	Half	Toyota	129TA7554
		140/55-9	124	165	5	17,0	Half	Yale - Hyster	129TA7555
			140	170	6	18,0	Half	Various	129TA7556
			150	180	6	18,0	Half	Various	107TA5387
5.00 F	10		130	160	8	16,5	Half	Various	107TA5386
			142	170	8	16,0	Half	Various	107TA5388
		6.50-10	127	165	5	16,0	Half	Yale - Hyster	129TA7557
		7.50-10	140	170	6	18,0	Half	Various	129TA7558
			150	180	6	18,0	Half	Daewoo	129TA7559
			150	180	6	18,0	Half	Various	107TA5390
			170	200	6	17,0	Half	Caterpillar	129TA7560
			130	160	8	17,0	Half	TCM	107TA5391
5.00 S	12		142	170	8	16,0	Half	Various	107TA5392
			105	140	10	18,5	Half	Hyster	129TA7561
		7.00-12	149,3	203,2	5	32,0	Half	Yale - Hyster	129TA7562
			175	220	5	27,0	Half	Various	107TA5393
			150	200	6	27,0	Half	Various	107TA5394
			166	218	6	32,0	Half	Yale - Hyster	129TA7563
			170	220	6	27,0	Half	Various	107TA5396
	170	220	6	32,0	Half	Various	107TA5395		
	145	190	8	26,0	Half	Toyota	107TA5397		



MULTIPLE PIECE RIM WITH RINGS



Structure:

- Can be supplied with or without locking rings.
- There are several different fittings possible per size, dependant on the brand and type of machine. Please use the "rim technical fill out form" (see next page) or contact TVH for more details.

Rim width (B1)	Rim diameter (D1)	Tyre size	Tyre size	Tyre size	Tyre size
3.00 D	8	4.00-8	5.00-8	125/75-8	15x4.5-8
3.25 D	8	4.00-8	5.00-8	15x4.5-8	
3.75 D	8	4.00-8	5.00-8		
4.33 R	8	16x6-8	150/75-8	18x7-8	180/70-8
7.00 E	8	18x9-8			
4.00 E	9	6.00-9	140/55-9		
6.00 E	9	21x8-9	200/75-9		
5.00 F	10	6.50-10	7.50-10	180/60-10	
6.50 F	10	23x9-10	225/75-10	200/50-10	
3.00	12	4.50-12			
5.00 S	12	7.00-12	5.70-12		
8.00 G	12	27x10-12	23x10-12		
3.75 P	13	25x6	23x5		
4.50	15	5.50-15	6.00-15		
5.50	15	7.00-15			
6.00	15	7.50-15	7.00-15		
6.50	15	200-15	7.50-15	8.25-15	
7.00	15	250-15	28x9-15	8.15-15	225/75-15
7.50	15	250-15	10.00-15		
8.00	15	300-15			
9.75	15	355/65-15	28x12.5-15	355/45-15	
6.00	16	7.50-16			
6.50	20	8.25-20	9.00-20		
7.00	20	9.00-20	10.00-20		
7.50	20	10.00-20	11.00-20		
8.00	20	10.00-20	11.00-20	12.00-20	
8.50	20	12.00-20			
10.00	20	12.00-20			
8.50	24	12.00-24			
10.00	24	14.00-24			



TYRES, RIMS & ACCESSORIES

For all our latest catalogue updates and company info: www.tvh.com

RIMS (WHEELS)



TECHNICAL FILL OUT FORM

Tyre dimension:

Rim type:

D1 = rim dia: inch

B1 = rim width: inch

D2 = bore dia: mm

L1 = flange position: mm

L2 = flange thickness: mm

C = pitch circle dia: mm

G = number of stud holes:

Company:

Customer code:

Name:

Fax number:

Truck make:

Truck type:

Serial nr:

Type A: splitwheel

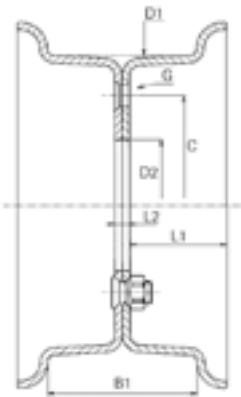

Type B: 2-way rim

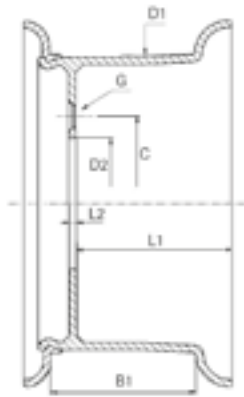

Type C: 3-way rim

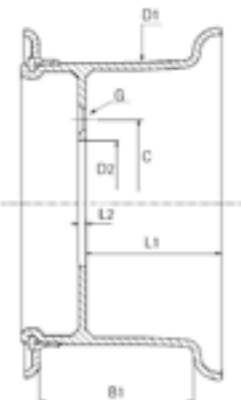

Type D: 4-way rim

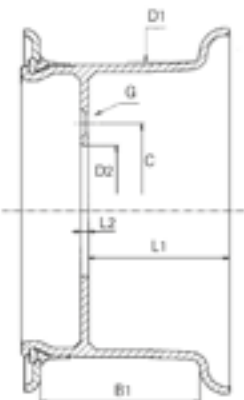

Please indicate type of stud holes

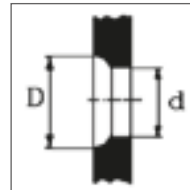

Spherical
d = mm
D = mm

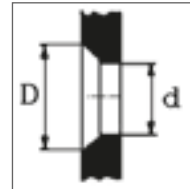

Conical
d = mm
D = mm

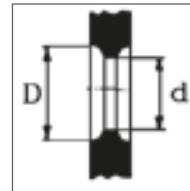

Double spherical
d = mm
D = mm

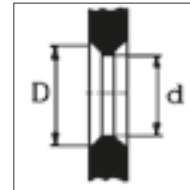

Double conical
d = mm
D = mm

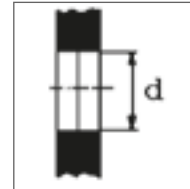

Straight hole
d = mm



SEPARATE RINGS

Rim rings type Lemmerz*

Rim size	Tyre size	Side ring	Lock ring	Seat ring
3.00 x 8	500 x 8 / 15 x 4,5 x 8	107TA5418	107TA5398	107TA5412
4.33 x 8	16 x 6 x 8 / 18 x 7 x 8	107TA5419	107TA5399	-
4.00 x 9	600 x 9 / 140 x 55 x 9	107TA5420	107TA5400	107TA5413
6.00 x 9	21 x 8 x 9	107TA5420	107TA5400	107TA5413
5.00 x 10	650 x 10	107TA5421	107TA5401	107TA5414
6.50 x 10	23 x 9 x 10 200 x 50 x 10	107TA5421	107TA5401	107TA5414
5.00 x 12	700 x 12	107TA5422	107TA5402	107TA5415
8.00 x 12	23 x 10 x 12 / 27 x 10 x 12	107TA5423	107TA5403	107TA5416
3.75 x 13	21 x 4 / 23 x 5	107TA5424	107TA5404	-
5.50 x 15	700 x 15	107TA5425	107TA5405	107TA5417
6.00 x 15	700/750 x 15	107TA5425	107TA5405	107TA5417
6.50 x 15	750 x 15	107TA5425	107TA5405	107TA5417
7.00 x 15	815 x 15 / 250 x 15	107TA5426	107TA5405	107TA5417
7.50 x 15	250 x 15 - 750	107TA5427	107TA5406	107TA5417
8.00 x 15	300 x 15	107TA5428	107TA5406	107TA5417
9.75 x 15	355 x 65 x 45	107TA5426	107TA5405	107TA5417

* Other types on request (brand of rim is required)



CLAMP FITTING RIMS

Used on Hyster, Clark, Caterpillar, Mitsubishi, TCM, Kalmar ...

There are several different possibilities per size, depending on the brand and type of machine

Sizes:

- 6.50 x 15,...
- 8.00 x 20,...
- 13.00 x 25,...
- 13.00 x 33



ALL RIMS CAN BE DELIVERED COMPLETE WITH TYRES, UPON REQUEST





TYRE PRESS

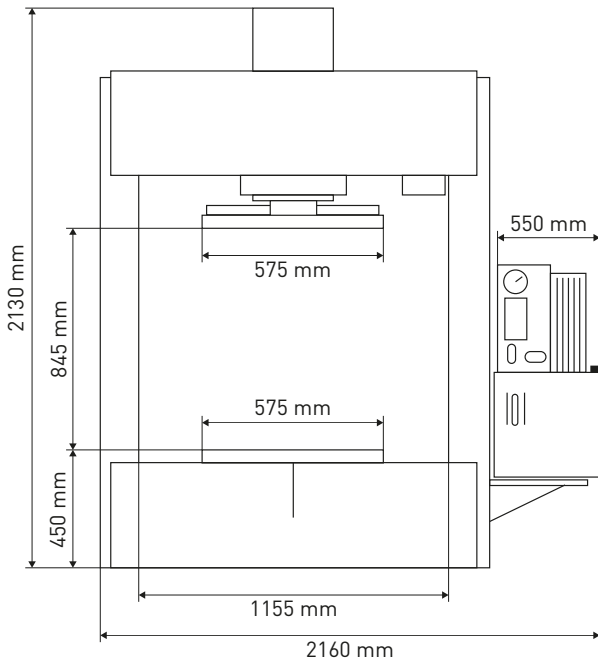

REF 127TA1038

380 V

REF 129TA7564

220 V

Specifications:

- Capacity: 120 ton
- Max tyre dimension: 20 inch
- Cylinder: double-acting
- Total height: 2222 mm
- Total width: 2160 mm
- Total depth: 850 mm
- Operating pressure: 230 bar
- Cilinder stroke: 290 mm
- Stroke complete out: 35 sec
- Oil tank: 30 l
- Electromotor: 10 hp (7,5 kW)
- 3-phase
- 50 Hz tension
- Shipping weight: 2000 kg
- Tools on request



TOTAL SOURCE®



TYRE PRESS 120 MS TON



REF 116TA6168

Specifications:

- Capacity: 120 ton
- Max. tyre dimension: 20 inch
- Cylinder: double-acting
- Total width: 2140 mm
- Total length: 3150 mm
- Total height: 2400 mm
- Between uprights: 1155 mm
- Between tables: 845 mm
- Operating pressure: 250 bar
- Cylinder bore: 250 mm
- Cylinder stroke: 400 mm
- Stroke complete out: 35 sec
- Stroke complete in: 25 sec
- Oil tank: 50 l
- Electromotor: 10 hp (7,5 kW)
- Shipping weight: 1900 kg
- No pressing tools included!

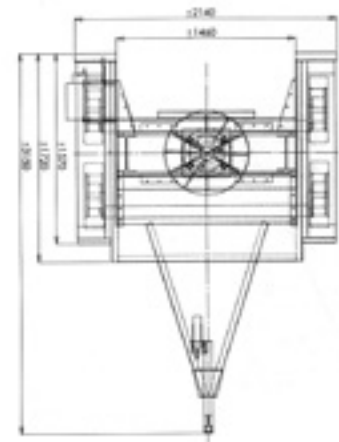
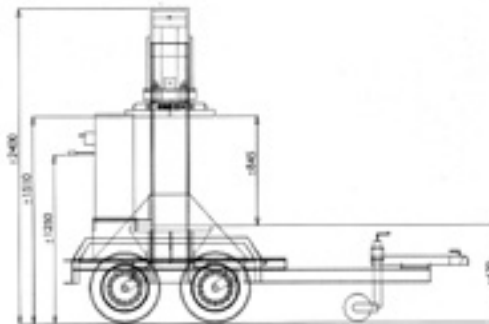

CLIP DEFITTING RINGS

For tyre size	REF
4.00-8, 5.00-8, 15x4.5-8	141TA4898
16x6-8, 18x7-8	141TA4899
6.00-9, 21x8-9	141TA4900
6.50-10, 23x9-10, 200/50-10	141TA4901
7.00-12	141TA4902
23x10-12, 27x10-12	141TA4903
All 15" wheels	141TA4904
All 20" wheels	141TA4905



REF 144TA8709

Complete kit



TYRES, RIMS & ACCESSORIES

For all our latest catalogue updates and company info: www.tvh.com

TYRE PRESS – FITTING TOOLS

PRESSING CONE

The pressing cone is placed on top of the wheel as a guidance for the tyre. This way, the tyre is always placed correctly on the wheel.



Wheel size	Tyre size	REF
300D-8	4.00-8 5.00-8	116TA6171
4.33-8	18x7-8 16x6-8	116TA6172
4.00-9 6.00-9	6.00-9 21x8-9	116TA6173
5.00-10 6.50-10	6.50-10 23x9-10	116TA6174
5.00-12	7.00-12 8.25-12	116TA6175
8.00-12	23x10-12 27x10-12	116TA6176

Wheel size	Tyre size	REF
3.11-13 3.75-13	22x4 1/2 23x5 25x6	116TA6177
All 15" wheels & tyres		116TA6178
For 15" twin-wheels		116TA6179
5.50-16 6.00-6	6.50-16 7.50-16	116TA6180
For 20" wheels & tyres		116TA6181
For 20" twin-wheels		116TA6182
8.50-24 10.00-24	12.00-24 14.00-24	116TA6183
For 24" twin-wheels		116TA6184

BASE TOOL



The base tool is placed under the wheel to protect the rim.

Wheel size	Tyre size	REF
3.00-8	4.00-8 5.00-8	107TA5340
4.33-8	18x7-8 16x6-8	111TA6195
4.00-9 6.00-9	6.00-9 21x8-9	107TA5341
5.00-10 6.50-10	6.50-10 23x9-10	111TA6196
5.00-12	7.00-12 8.25-12	107TA5342
8.00-12	23x10-12 27x10-12	107TA5343
3.11-13 3.75-13	22x4 1/2 23x5 25x6	116TA6192
All 15" wheels		107TA5344
All 20" wheels		116TA6193
8.50-24 10.00-24	12.00-24 14.00-24	116TA6194

FLANGE TOOL



The flange tool is used to push the sidering and the tyre down to free up some space to mount the locking ring.

Wheel size	Tyre size	REF
3.00-8	4.00-8 5.00-8	116TA6202
4.33-8	18x7-8 16x6-8	
4.00-9 6.00-9	6.00-9 21x8-9	
5.00-10 6.50-10	6.50-10 23x9-10	107TA5346
5.00-12	7.00-12 8.25-12	116TA6203
8.00-12	23x10-12 27x10-12	
3.11-13 3.75-13	22x4 1/2 23x5 25x6	
All 15" wheels		107TA5348
All 20" wheels		116TA6204
8.50-24 10.00-24	12.00-24 14.00-24	116TA6205

SET OF FITTING TOOLS – ALL WHEELS BETWEEN 8" AND 15"

REF [112TA4944](#)

- 7 press cones
- 4 press cages
- 7 supporting rings

SET OF FITTING TOOLS FOR 20" WHEELS

REF [141TA4892](#)

- 1 press cone
- 1 press cage
- 1 supporting ring



ADVANCED BAND TOOL

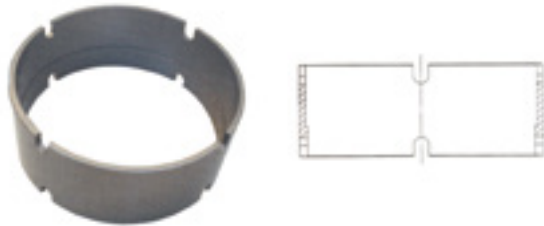

The advanced band tool is used to press the advanced band between the tyre and the wheel.

Wheel size	Tyre size	REF
3.00-8	400-8	116TA6195
	5.00-8	
4.00-9	6.00-9	116TA6196
	21x8-9	
5.00-10	6.50-10	116TA6197
	23x9-10	
5.00-12	7.00-12	116TA6198
	8.25-12	
8.00-12	23x10-12	
	27x10-12	
All 15" wheels		116TA6199
All 20" wheels		116TA6200
All 24" wheels		116TA6201

DEMOUNTING SUPPORT

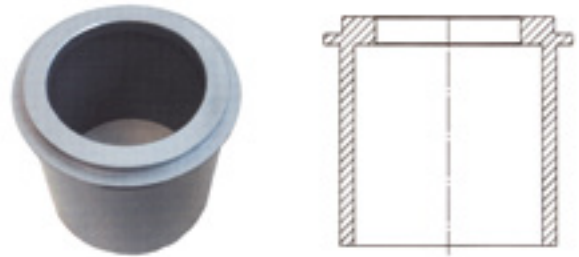

The demounting support is used to support the wheel during demounting.

Wheel size	Tyre size	REF
3.00-8	4.00-8	116TA6211
	5.00-8	
4.33-8	18x7-8	
	16x6-8	
4.00-9	6.00-9	116TA6212
	21x8-9	
5.00-10	6.50-10	116TA6213
	23x9-10	
5.00-12	7.00-12	116TA6214
	8.25-12	
8.00-12	23x10-12	
	27x10-12	
3.11-13	22x4 1/2	116TA6215
	23x5	
	25x6	
All 15" wheels		116TA6216
All 20" wheels		116TA6217
8.50-24	12.00-24	116TA6218
	14.00-24	

DEMOUNTING TOOL



The demounting tool is used to push the tyre away from the wheel after removal of the locking.

Wheel size	REF
All 8" wheels	116TA6206
All 10" wheels	116TA6207
All 15" wheels	116TA6208
All 20" wheels	116TA6209
All 24" wheels	116TA6210

PRESS-ON TOOL

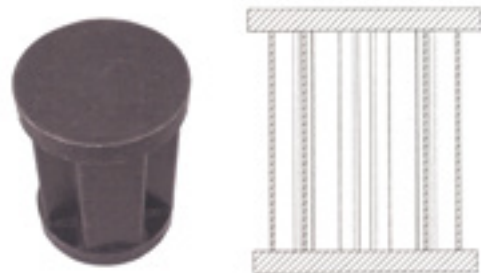

The press-on tools are used to mount and demount the cushion tyres.

Wheel size	REF
4 + 5	116TA6219
6 + 6 1/4	116TA6220
6 1/2 + 8	116TA6221
10 x 10 1/2	116TA6222
11 1/4 + 12 1/8	116TA6223
14 + 15	116TA6224
16 (together with REF 116TA6224)	116TA6225
17 3/4 + 20	116TA6226
22 (together with REF 116TA6226)	116TA6227
20 + 22	116TA6227



TYRES, RIMS & ACCESSORIES

For all our latest catalogue updates and company info: www.tvh.com

TYRE SHOP – REPAIR EQUIPMENT

PATCH KITS

Diameter	Pieces	REF
30 mm	100	143TA3391
35 mm	30	143TA3392
45 mm	30	143TA3393
54 mm	30	143TA3394
75 mm	30	143TA3395
94 mm	10	143TA3396
116 mm	10	143TA3397



OVAL PATCHES

Dimensions	Pieces	REF
74 x 37 mm	30	143TA3398
90 x 47 mm	30	143TA3399
150 x 75 mm	10	143TA3400



TYRE (CARCASS) PATCHES

Fig	Ply rating	Dia patch	Quantity	REF
1	4	255 mm	10	106TA6438
	4	370 mm	5	106TA6439
	4	510 mm	3	106TA6440
	6	255 mm	10	106TA6441
	6	370 mm	5	106TA6442
	6	510 mm	3	106TA6443
2	4	160 mm	5	106TA6444
	6	235 mm	5	106TA6445
	8	265 mm	5	106TA6446



REPAIR PATCHES BLUE

Description	Diameter	REF
02	80 mm	143TA3433
03	100 mm	143TA3434
04	120 mm	143TA3435
05	160 mm	143TA3436
06	240 mm	143TA3437
20	255 mm	143TA3438
22	510 mm	143TA3439
23	255 mm	143TA3440
24	370 mm	143TA3441
25	510 mm	143TA3442





REPAIR PATCHES

Description	Dimensions	REF
120 TL	80 x 125 mm	143TA3423
125 TL	115 x 125 mm	143TA3424
135 TL	130 x 180 mm	143TA3425
140 TL	100 x 195 mm	143TA3426
180 TL	155 x 195 mm	143TA3427
182 TL	190 x 245 mm	143TA3428
184 TL	215 x 295 mm	143TA3429
186 TL	250 x 345 mm	143TA3430
188 TL	280 x 450 mm	143TA3431
190 TL	310 x 550 mm	143TA3432



VALVE + RUBBER FEET VG8



REF [143TA3448](#)

5 pieces



VALVE – WATER AND AIR



REF [143TA3447](#)

10 pieces



TYRE REPAIR KIT

REF [143TA3403](#)

Contents:

- 8 tube patches no. 1
- 2 tube patches no. 2
- 1 tube patch no. 3
- 1 tube patch no. 4
- 1 tube patch no. 5
- 2 tube patches no. 7
- 1 tube patch no. 7A
- 1 tube patch no. 7B
- 1 tube vulcanization liquid (25 g)
- 3 metal rasps
- 3 inner valves, short





TYRES, RIMS & ACCESSORIES

For all our latest catalogue updates and company info: www.tvh.com

TYRE SHOP – REPAIR EQUIPMENT

TYRE REPAIR KIT

REF 143TA3404

Contents:

- 12 tube patches no. 1
- 6 tube patches no. 3
- 2 tube patches no. 4
- 1 tube patch no. 5
- 3 tube patches no. 7
- 4 tube patches no. 7A
- 2 tube patches no. 7B
- 1 tube vulcanization liquid (50 g)
- 1 rasp
- 1 spare blade for rasp
- 1 roller



TYRE REPAIR KIT

REF 143TA3402

Contents:

- 4 tube patches no. 1
- 2 tube patches no. 2
- 1 tube patch no. 3
- 1 tube patch no. 4
- 1 tube patch no. 7
- 1 tube patch no. 7A
- 1 metal rasp
- 1 tube vulcanization liquid (10 g)



TUBE WITH GLUE



REF 143TA3415

25 g/35 ml

REF 143TA3406

60 g



BOTTLE WITH GLUE



REF 143TA3407

175 g

REF 143TA3408

500 g

- For the vulcanisation of tube patches rubber based valves and valve patches
- Free from CFC and aromatic compounds





SPECIAL BLUE CEMENT – ALL UTILIZATIONS

REF 143TA3417

350 g

- Repair product for tyres
- Accelerator solution for the application of repair patches
- Used for self-vulcanization starting from 18 °C through to hot vulcanization up to 150 °C

REF 143TA3416

1 kg



LIQUID BUFFER

REF 143TA3409

250 ml

- Repair product for tubes
- Free of CFC and aromatic compounds
- For quick and easy cleaning and buffing of tubes
- For chemical cleaning before mechanical buffing

REF 143TA3410

500 ml

REF 143TA3411

1 l



TYRE GREASE

REF 107TA5314

Drum of 5 kg

- For fast, gentle and easy fitting and demounting of all standard tyre/rim combinations
- Non-spattering
- Chemically neutral with respect to rubber and metal
- Excellent lubrication for mounting and demounting operations = fewer injuries
- Promotes adhesion between rim and tyre, prevents tyre slippage

REF 107TA5315

Drum of 10 kg





GREASE BRUSH



REF [107TA5316](#)

TYRE CHISEL



REF [107TA5317](#)

- Tyre chisel
- Demounting equipment

TYRE IRON FORCE



REF [140TA9088](#)

TYRE LEVER



REF [107TA5318](#)

- Tyre lever heavy-duty, offset pattern
- Vanadium steel, chrome-plated
- Length: 610 mm (24")



TYRE PROTECTION

Reduce tyre repair times

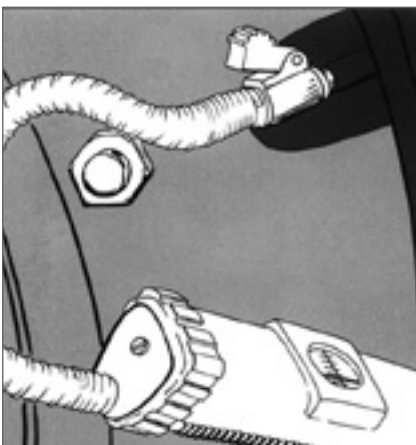
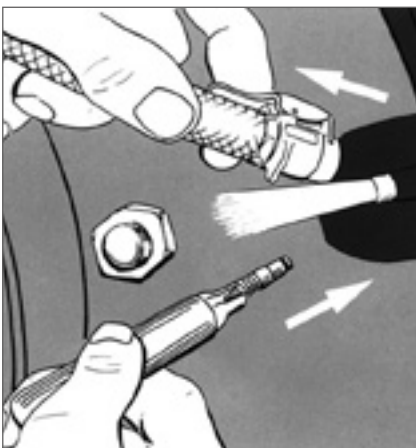
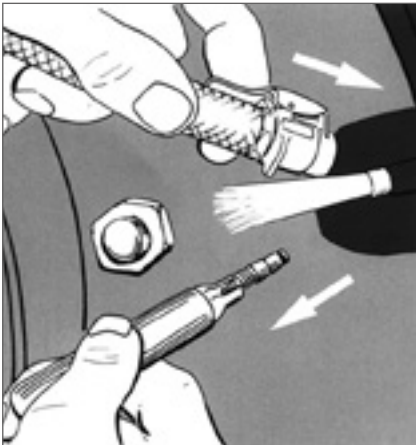

New antipuncture

REF 107TA5327

Drum 20 l

REF 107TA5328

Pump for drum 20 l

REF 107TA5329

Bottle 1 l

Puncture Sealant is a non-toxic liquid mixture in the tyre.

As the wheel rotates, it is spread around the crown area and coats the inside of the tyre or tube.

When a tyre is punctured, sealant is forced instantly into the hole, permanently sealing punctures caused by objects up to 5 mm in diameter; equivalent to a 5 inch nail!

The unused sealant remains in the tyre for the next puncture, but it can be easily washed out with water if a conventional repair or remould is to be done. The sealant is introduced into either tubed or tubeless tyres through the valve stem before they are inflated to their recommended operating pressure.

Once inside the tyre, it will seal puncture after puncture after puncture, effectively and permanently.

This formula is suitable for caravans, boats and camping trailers, tractors, motor cycles, pedal cycles and wheelchairs.

It is not a temporary repair product but an effective sealant that creates permanent repairs, eliminating the loss of time and the expense of stripping down the punctured tyre to carry out a traditional repair.

Full instructions are sent with each pack of Puncture Sealant and must be referred to before use. Example: 1 litre bottle treats approx. 2 caravan/trailer tyres or 10 BMX bicycle tyres.



- Up to diameter: 5 mm
- Suitable for tyres with or without inner tube

For filling capacity see next page!



TYRES, RIMS & ACCESSORIES

For all our latest catalogue updates and company info: www.tvh.com

TYRE SHOP – REPAIR EQUIPMENT

PUNCTURE SEALANT

Tyre dimensions	Litres per tyre	Tyre dimensions	Litres per tyre	Tyre dimensions	Litres per tyre
3.00 x 4 3.00 x 6 4.80 x 4.00 x 8 9.00 x 3.50 x 4 9.00 x 3.50 x 6 11.00 x 4.00 x 4 11.00 x 4.00 x 5	1/4 l	7.50 x 16 7.50 x 18 8.50 x 15 9.00 x 15 7.50 x 20 8.00 x 18 8.25 x 16 10.50 x 15	1 1/2 l	9.50 x 48 11.20 x 38 13.60 x 24 16.50 x 16.1 11.20 x 36 13.00 x 25 14.50 x 20 360 – 70 x 24	4 l
3.50 x 8 4.00 x 8 14.00 x 4.00 x 6 4.00 x 10 5.00 x 8 14.50 x 4.50 4.00 x 12 4.00 x 15 15.00 x 6.00 x 8 13.00 x 5.00 x 6 13.00 x 6.00 x 6 13.00 x 6.50 x 6	1/2 l	8.25 x 20 9.00 x 16 9.50 x 17.5 10.00 x 12 9.00 x 20 9.50 x 20 10.00 x 15.3 10.00 x 16.5 10.50 – 85 x 15.3 11.00 – 65 x 12 12.00 x 12 10.00 x 16	2 l	12.40 x 32 13.00 x 32 19.00 – 45 x 17 380 – 70 x 24 12.40 – 78 x 36 13.60 – 78 x 23 16.00 x 20 360 – 70 x 28	4 1/4 l
5.50 – 85 x 9 6.00 x 9 16.00 x 6.50 x 8 18.00 x 7.00 x 8	3/4 l	7.20 x 40 8.30 x 32 9.50 x 24 10.00 x 20 10.00 x 22.5 10.50 x 20 11.00 x 16 11.50 x 15 11.50-70 x 18 12.00 x 15 20.00 x 20 33.00 x 12.50 x 15	2 1/4 l	12.40 x 38 14.00 x 25 14.90 x 24 16.50 – 70 x 22.5 14.00 x 28 15.00 x 28 18.00 x 19.5 420 – 70 x 24	4 3/4 l
6.50 x 10 18.00 x 9.50 x 8 18.50 x 8.50 18.00 x 8.50 x 8	1 l	7.20 x 40 8.30 x 32 9.50 x 24 10.00 x 20 10.00 x 22.5 10.50 x 20 11.00 x 16 11.50 x 15 11.50-70 x 18 12.00 x 15 20.00 x 20 33.00 x 12.50 x 15	2 1/2 l	12.40 x 46 15.50 x 25 16.00 x 24 17.00 – 80 x 20 13.60 x 38 14.90 x 30 16.90 x 24 420 – 70 x 28	5 1/4 l
7.50 x 10 20.00 x 10 x 8 22.50 x 10 x 8 23.00 x 10.50 x 12 23.50 x 8.50 x 12 25.00 x 12.00 x 9 27.00 x 8.50 x 15 28.00 x 9.00 x 15	1 1/2 l	8.30 x 36 8.30 x 38 11.00 x 20 11.00 x 22.5 11.20 x 20 12.00 x 16.5 12.00 x 18 12.00 x 12.5 x 18	2 3/4 l	14.00 x 34 16.50 x 28 16.90 x 26 420 – 70 x 30 14.00 x 38 14.90 x 38 15.50 x 38 17.50 x 24	5 3/4 l
20.00 x 20 33.00 x 12.50 x 15	2 1/2 l	8.30 x 44 11.00 x 24 12.00 x 20 12.00 x 22.5 12.50 x 18 12.50 x 20 13.50 x 16	3 l	18.00 x 24 18.00 x 25 18.40 x 24 19.50 x 24 16.00 x 38 18.40 x 28 480 – 70 x 30 20 – 65 x 25	6 l
4.00 x 19 4.50 x 16 4.50 x 19 5.00 x 12 5.00 x 14 5.00 x 15 5.00 x 16	3/4 l	9.50 x 36 9.50 x 38 11.20 x 24 11.50 x 24 14.00 – 65 x 16 15.00 – 55 x 17 11.20 – 78 x 28 320 – 70 x 24	3 1/4 l	16.00 x 38 18.00 x 33 18.50 x 44 21.00 x 24 20.50 x 25 21.00 x 25 22.00 x 24 480 – 70 x 38	6 1/2 l
5.50 x 16 6.50 – 80 x 15 7.00 x 14 20.00 x 8 x 10	1 l	9.50 x 44 12.00 x 24 14 x 20 15.00 – 70 x 18	3 1/2 l		7 l
6.00 x 19 6.00 x 20 6.50 x 16 7.00 x 15 8.50 x 12 8.50 x 14 9.50 x 28 195 x 14	1 1/4 l		3 1/4 l		7 1/2 l
6.50 x 20 7.00 x 16 7.00 x 19 7.20 x 16	1 1/2 l				8 l

REF 107TA5327
Drum 20 l



REF 107TA5328
Pump for drum 20 l



REF 107TA5329
Bottle 1 l





PRESSURE GAUGE



REF 107TA7780

- Professional pressure gauge
- Operating pressure: 0,7-12 bar (10-174 psi)
- Analogue display
- Length hose: 1,5 m

Michelin-licensed

DIGITAL TYRE INFLATOR



REF 140TA9075

1949DGT

- Operating pressure: 0–11 bar (2.0–160 psi)
- 4 measurement units: psi/bar/kg per cm²/kPa
- Backlit LCD display
- Reset function
- Self-power off after 3 min
- Pressure release button
- Hose length: 530 mm
- Resolution: 0,05 bar
- ABS housing, protective rubber shell on gauge, shockproof
- Power supply: 2 AAA size 1,5 V batteries (included)

Beta
Beta Utensil S.p.A. Authorized Dealer

COMPRESSOR





REF 107TA7627

- Oil-lubricated direct driven compressor
- 24 l tank
- Max pressure: 10 bar (145 psi)
- Flow: 340 l/min
- Motor: 3 hp (2,2 kW)
- 230 V – 50 Hz
- Equipped with double handle for extra user comfort



TYRE CUTTER

Type	Width	Depth	Quantity	REF
Round 	3-5 mm	7 mm	20	107TA5302
	5-8 mm	7 mm	20	107TA5303
	6-15 mm	10 mm	20	107TA5304
	8-16 mm	12 mm	20	107TA5305
	10-18 mm	12 mm	20	107TA5306
Large 	3-5 mm	7 mm	20	107TA5307
	5-6 mm	7 mm	20	107TA5308
	7-10 mm	10 mm	20	107TA5309
	9-13 mm	12 mm	20	107TA5310
	11-15 mm	12 mm	20	107TA5311
	23-28 mm	12 mm	10	107TA5312

Boxes of blades sold separately



REF 107TA5313

- Heavy-duty
- Professional "Rubber cut"
- 220-240 V
- RILLIFT 6
- Reliable
- Modern
- Technically refined

VALVE EXTENSIONS

Dimensions	REF
30 mm	107TA5320
50 mm	107TA5321
80 mm	107TA5322
130 mm	107TA5323
160 mm	123TA9621



REF 107TA5319

Valve stem cover - plastic

INTERIOR VALVE SCREWDRIVER



REF 140TA9087





AIR PUMP NIPPLE



REF 140TA9097
Diameter: 8 mm

PLASTIC EXTENSION WHITE



REF 140TA9093
Length: 115 mm

REF 140TA9094
Length: 150 mm

REF 140TA9095
Length: 170 mm

DUAL FOOT CHUCKS TWIN WHEELS



REF 140TA9096
Length: 115 mm

TUBELESS VALVE



REF 140TA9101



VALVE TYRE

REF 140TA9098
DIN 78026 50 MSW

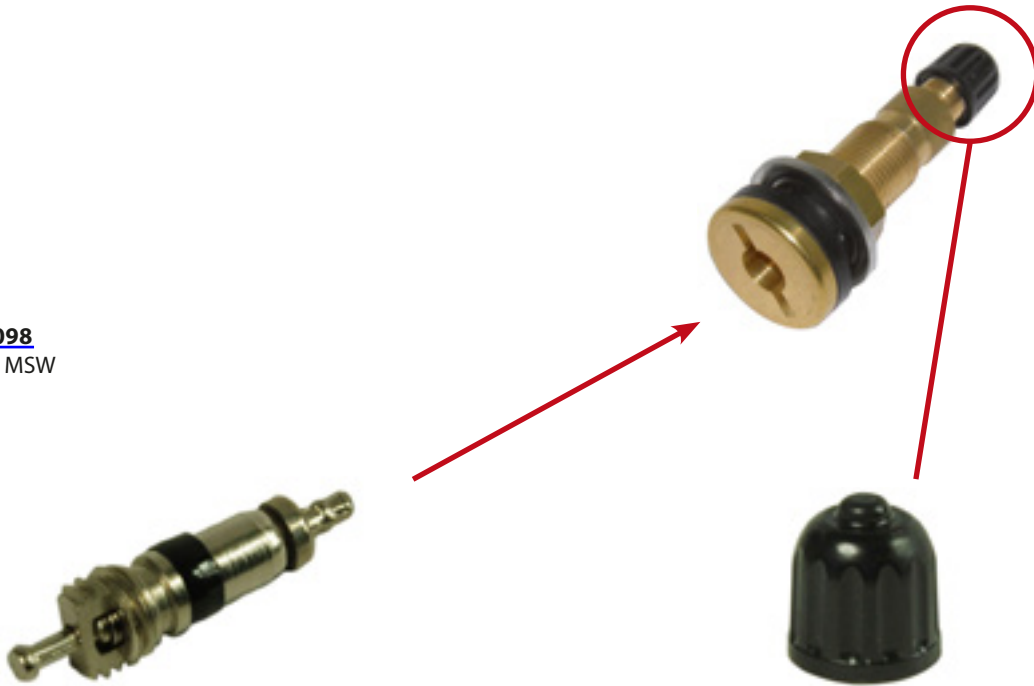

REF 143TA3449
• Valve core
• Set of 100 pieces

REF 143TA3444
• Nylon valve caps
• Set of 100 pieces



VALVE CAP SCREWDRIVER TYPE



REF 143TA3450
Set of 100 pieces

TYRE VALVE KEY



REF 143TA3454



WHEEL DOLLY

REF 107TA5332

Features:

- Polished and chromium-coated ram plunger and pump piston protecting seals from abrasion
- Heat-treated serrated saddle securing lifting contact during operation
- Heat-treated extension screw providing adjustable lifting height
- Built-in safety valve ensuring operating safety against overloading
- Patented hydraulic bypass system preventing ram plunger from over-travelling
- Load restraining chain securing lifting and lowering safety
- Swivel rear castor with height adjustable mechanism offering easy manoeuvrability and maximizing operating stability



TYRE DOLLY



REF 107TA5330

Facilitates tyre mounting on your forklifts

HYDRAULIC JACK AND STANDS

1 Hydraulic jack

REF 107TA8185

- Min height: 60 mm
- Max height: 360 mm
- Lifting capacity: 4000 kg
- Weight: 31 kg
- With CE-certificate

2 Stands

REF 105TA4047

- Max height: 420 mm
- Min height: 240 mm
- Capacity: 9000 kg
- Extra wide base: 240 mm

REF 115TA4429

Complete kit (jack (1) and stands (2))

REF 106TA8633

Repair kit



Large base area!



SHOE CLAW



REF [115TA2133](#)

With connecting chain, see picture (for use on snow + ice)

REF [136TA1301](#)

Rubber replaces the connecting chain (only for use on ice)

- Protects you from slipping
- Achieve the best safety in walking with the help of a combination of ice-spike and snow chain
- Fast and easy to use
- Elastic from size 37 to 46
- TÜV tested & CE-marked (directive 89/686/EEC)
- Packed as a pair in an attractive, practical suitcase with synthetic material



STARTING ASSISTANCE

The universal getaway-aid or starting assistance for passenger-cars, vans and trucks. A plus for security in the extreme situations of winter.

- Safety on ice and snow
- Suitable for all sizes
- Fast and easy mounting system
- Attractive packaging



REF [115TA2132](#)

Passenger cars



REF [115TA2131](#)

Vans + 4x4



REF [115TA2130](#)

Trucks

SNOW CHAINS

Tyre dimensions	REF
500 x 8	107TA5259
18 x 7 x 8	107TA5260
600 x 9	107TA5261
21 x 8 x 9	107TA5262
200 x 50 x 10	107TA5272
650 x 10	107TA5263
23 x 9 x 10	107TA5264
23 x 10 x 12	107TA5265
700 x 12	107TA5266
27 x 10 x 12	107TA5267
825 x 15	107TA5268

Tyre dimensions	REF
815 x 15 (28 x 9 x 15)	107TA5269
700 x 15	107TA5270
750 x 15	107TA5271
250 x 15	107TA5273
300 x 15	107TA5274
355 x 65 x 15	107TA5275



See our snow chains installation movie



Always delivered in pairs!



ICE STUDS

Studs are good for use on icy and hard, damped snow. Don't use the studs in snow, there you must use snow chains. Studs can also be used only outside, as driving inside can damage the floor due to the hardness of the studs.

Fitting:

Always check that the tread depth is sufficient before fitting

Basic rules:

- Never fit a stud that is too long for the tread depth, i.e. an 18 mm stud requires a 17 mm tread depth.
- 3 mm of the stud should be raised above the tyre surface.
- The thickness of the cord varies between 4 and 20 mm depending on the tyre type.
- To achieve optimal results, count the number of contact patches on the tyre and make a strategy for fitting the studs. If unsure, choose a shorter stud model. There are several sizes to fit various tread depths.
- The stud is easily fitted and dismantled with a special installation tool that is supplied with the product.
- Initially, the tool is set to the basic setting to provide a 3 mm projection of the stud above the tyre surface.
- The projection may vary depending on the resistance of the rubber; in some cases the tool must be reset.
- Learning how to fit the studs is easy.
- In order to remove the studs, the special tool is adjusted backwards.
- The correct distance between the rubber and hard metal edge is 3 mm.



Length	Pieces per package	REF
15 mm	100	136TA2984
15 mm	150	136TA2985
15 mm	200	136TA2986
18 mm	100	136TA2987
18 mm	150	136TA2988
18 mm	200	136TA2989
25 mm	200	136TA2990
30 mm	200	136TA2991

WHEEL COVERS



REF [139TA1675](#)

Wheel diameter: 10"-16"

REF [139TA1676](#)

Wheel diameter: 17"-22"

REF [125TA6262](#)

Wheel diameter: 23"-33"

REF [125TA6263](#)

Wheel diameter: 34"-44"

REF [125TA6264](#)

Wheel diameter: 45"-52"

Ideal for:

- Showrooms
- Renovation & restoration works
- Exhibitions
- Set of 4 pieces. Also available separately
- Intensive use will result in reduced lifespan

Maximum speed

5 km/h

Only for aerial work platforms. No forklift use.



LOOSE WHEEL NUT INDICATORS

The loose wheel nut indicator is an easy-to-use and cost-effective product that provides immediate certainty if any of the wheel nuts have come loose, through a quick visual inspection.

Daily inspection:

After installing the **loose wheel nut indicators**, the driver is advised to perform a daily visual inspection of his vehicle or trailer. These **loose wheel nut indicators** can also be installed during a "first-use" inspection of a new or different vehicle. They increase **safety, facilitate technical inspections** and **reduce wheel nut-related problems**. Fortunately wheel loss occurs only rarely. Loose wheel nuts however frequently cause damage to tyres, rims, hubs and wheel nuts.

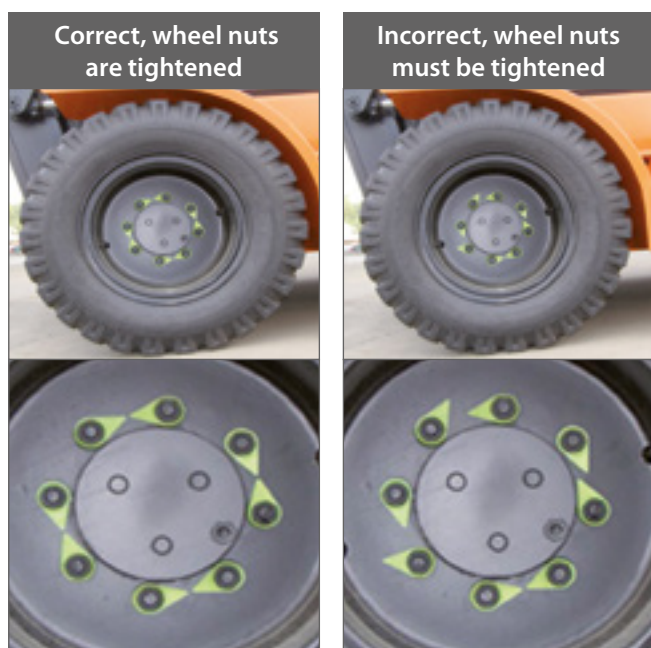

Sizes, range and colours

Loose wheel nut indicators are available in a range of sizes:

- Indicators for nearly 100% of all vehicles in use
- The standard colour fluorescent yellow is a stock item

Spanner width	REF fluorescent yellow
17 mm	116TA6240
18 mm	116TA6241
19 mm	116TA6242
20 mm	116TA6243
21 mm	116TA6244
22 mm	116TA6245
23 mm	116TA6246
24 mm	116TA6247
25 mm	116TA6248
26 mm	116TA6249
27 mm	116TA6250
28 mm	116TA6251
29 mm	116TA6252
30 mm	116TA6253
31 mm	141TA9935
32 mm	116TA6254
33 mm	116TA6255
34 mm	116TA6256
35 mm	141TA9936
36 mm	116TA6257
38 mm	116TA6258
40 mm	116TA6259
41 mm	116TA6260

SPLIT RIM FITTING TOOL: TIMESAVER



The ideal aid for the fitting of tyres on split rims, making sure all bolt holes are aligned perfectly once the tyres are fitted. Bolting 2 split rim halves together will become a piece of cake.

Suitable for: split rim REF	Fitting tool: REF	Suitable for: split rim REF	Fitting tool: REF
107TA5393	141TA3245	107TA5387	141TA3250
107TA5395	141TA3246	107TA5380	141TA3251
107TA5390	141TA3247	107TA5391	141TA3252
107TA5382	141TA3248	107TA5397	141TA3253
107TA5386	141TA3249	107TA5396	141TA3254



GROUND SUPPORT PLATES



Advantages:

- Extremely strong and flexible
- High wear-resistance
- Lightweight
- Easy to stack

Characteristics:

- Carrying capacity up to 50 tonnes per plate
- Standard with 2 handles per plate (1 per short side)
- Made of 100% durable recycled synthetic material (UHMWPE)
- Standard with a smooth surface
- Technical sheet available on request
- Not suitable to span gaps or for machines with steel tracks

Length	Width	Thickness	Weight	REF
2000 mm	1000 mm	15 mm	30 kg	134TA8181
2000 mm	1000 mm	20 mm	40 kg	134TA8182
3000 mm	1000 mm	15 mm	45 kg	134TA8185
3000 mm	1000 mm	20 mm	60 kg	134TA8186



Applications

Horticulture:

- Lawns
- Driveways & terraces
- Sports fields

Events:

- Temporary sidewalks
- Car parkings
- Floors

Construction industry



Storage rack for ground support plates



- Available in 2 dimensions
- Convenient storage for multiple ground support plates
- For easy transport of your ground support plates (with forklift)

Length	Width	Stack height	REF
2000 mm	1000 mm	435 mm	138TA8304
3000 mm	1000 mm	435 mm	138TA8303

Connector for ground support plates



REF 127TA2465

Suitable for ground support plates with a thickness of 15 mm

Extra options

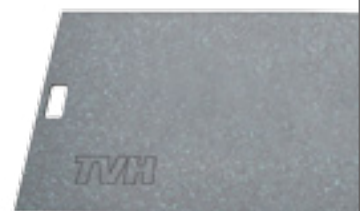

Free engraving of company name or logo (from 50 pieces onwards)



STABILIZER PLATES

Look up via

PS MyProductSearch



Advantages:

- Light, with carrying strap
- Compact
- Durable
- Extremely strong
- Water-repellent
- Easy to maintain

Applications:

- Mobile cranes
- Construction cranes
- Car cranes
- Telescopic lift trucks
- Aerial work platforms
- Concrete pumps
- Scaffolding
- ...



Dimensions	Weight	Plate capacity	REF
400 x 400 x 40 mm	6	10000	107TA9631
400 x 400 x 60 mm	9	12000	107TA9632
500 x 500 x 40 mm	10	15000	107TA9633
500 x 500 x 50 mm	12	15000	107TA9634
500 x 500 x 60 mm	14	20000	107TA9635
600 x 600 x 40 mm	14	20000	107TA9636
600 x 600 x 60 mm	21	25000	107TA9637
800 x 800 x 40 mm	25	25000	107TA9638
800 x 800 x 50 mm	32	30000	107TA9639
800 x 800 x 60 mm	37	35000	107TA9641

Holders for stabilizer plates



For storage of 1 or 2 stabilizer plates

Available in 3 dimensions:

Dimensions	Plate thickness	REF
1 plate		
400 x 400 mm	40/50 mm	138TA8154
500 x 500 mm	40/50/60 mm	138TA8155
600 x 600 mm	40/50/60 mm	138TA8156
2 plates		
400 x 400 mm	40/50/60 mm	138TA8157
500 x 500 mm	40/50/60 mm	138TA8158
600 x 600 mm	40/50/60 mm	138TA8159

Characteristics:

- Made of galvanized steel
- Universal mounting ability



RUBBER TRACKS & UNDERCARRIAGE PARTS

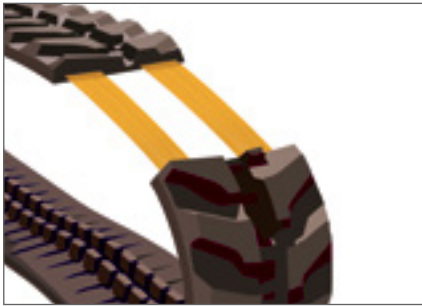

TotalSource®

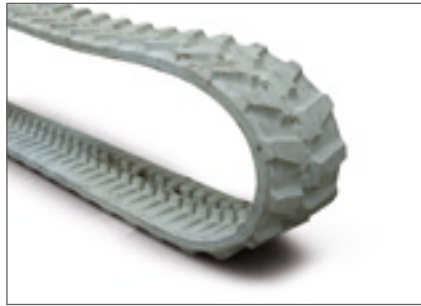

Non-marking rubber tracks



Large rubber tracks

Advantage:

Continuous metal inner belt

Suitable for:

- Aichi
- Bobcat
- Case
- Caterpillar
- Daewoo
- Gehl
- Hanix
- Hinowa
- Hitachi
- IHI
- JCB
- Kobelco
- Komatsu
- Kubota
- Morooka
- Neuson
- New Holland
- Oil & Steel
- Peljob
- Sunward
- Takeuchi
- Terex-Schaeff
- Teupen
- Volvo
- Yanmar
- ...



We supply:

- Idlers
- Sprockets
- Top rollers & track rollers for rubber tracks



TRACKS & UNDERCARRIAGE PARTS CATALOGUE

REF 22657942

An overview of all track rollers, top rollers, sprockets, idlers and tracks
You will also find a selection of MRO products that apply to the Tracs & undercarriage parts.

Please contact us to order your Tracks & undercarriage parts catalogue.





RUBBER TRACKS – TRACK SIZE IDENTIFICATION

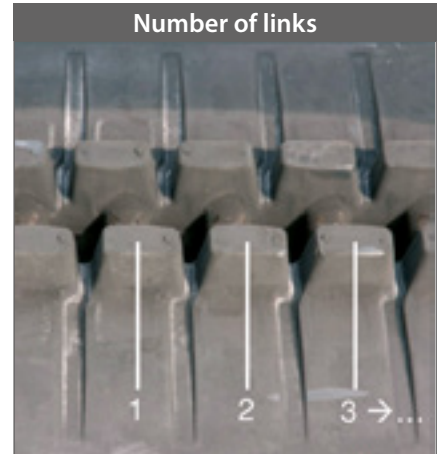
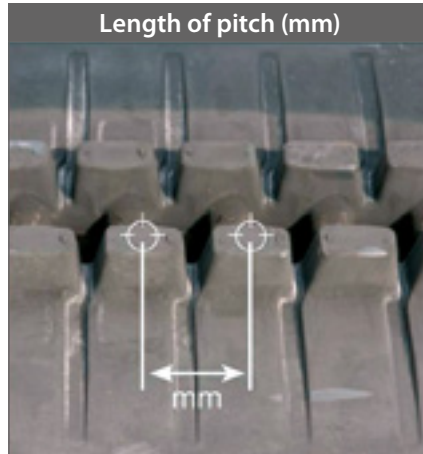

Brand of machine:

Type of machine:

Track width (mm):

Length of pitch (mm):

Number of links:





RUBBER TRACKS – SPECIFICATION

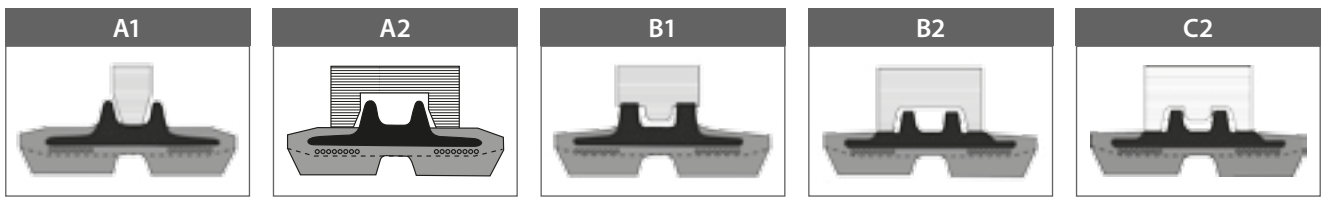

Width x pitch	Links	W2	W3	H1	H2	W4 (steel pin)	Guiding
150x72	29 <-> 40	21 mm	64 mm	23 mm	24 mm	25 mm	A2
180x60	30 <-> 40	23 mm	60 mm	28 mm	26,5 mm	26 mm	A1
180x72	28 <-> 58	23 mm	68 mm	28 mm	27 mm	26 mm	A2
180x72k	30 <-> 37	20 mm	61 mm	22 mm	19,5 mm	-	B2
200x72	34 <-> 47	27 mm	80 mm	28 mm	31 mm	32 mm	A2
200x72k	37 <-> 47	24 mm	68 mm	30 mm	30 mm	34 mm	A2
230x48	60 <-> 84	23 mm	74 mm	25 mm	25 mm	24 mm	B1
230x72	42 <-> 56	23 mm	76 mm	30 mm	26 mm	40 mm	A2
230x96	30 <-> 48	24 mm	74 mm	22 mm	24 mm	26 mm	B1
230x101	30 <-> 36	24 mm	75 mm	23 mm	29 mm	22 mm	B1
250x47	84	25 mm	66 mm	23 mm	20 mm	21 mm	B2
250x48,5 (offset)	84	24 mm	66 mm	21 mm	20 mm	-	B2
250x52,5	72 <-> 78	30 mm	80 mm	22 mm	21 mm	24 mm	B2
250x72	47 <-> 57	23 mm	76 mm	30 mm	26 mm	40 mm	A2
260x96	35 <-> 38	24 mm	76 mm	24 mm	20 mm	21 mm	B2
260x107		30 mm	84 mm	24 mm	26 mm	24 mm	-
260x109	35 <-> 39	29 mm	86 mm	26 mm	29 mm	31 mm	B1
280x72	45 <-> 64	25 mm	78 mm	30 mm	24 mm	31 mm	A2
280x106	35 <-> 42	30 mm	80 mm	28 mm	28 mm	30 mm	B2
300x52,5n	72 <-> 98	30 mm	78 mm	22 mm	18 mm	25 mm	B1
300x52,5w	72 <-> 92	40 mm	92 mm	24 mm	21 mm	28 mm	B1
300x52,5k	70 <-> 84	29 mm	86 mm	28 mm	31 mm	24 mm	B2
300x53	80 <-> 84	31 mm	88 mm	25 mm	19,5 mm	-	B2
300x55	70 <-> 86	30 mm	82 mm	26 mm	26 mm	25 mm	B1
300x55,5 (offset)	76 <-> 82	30 mm	82 mm	23 mm	27 mm	27 mm	B2
300x109N	35 <-> 42	30 mm	78 mm	27 mm	28 mm	22 mm	B1
300x109W	35 <-> 44	40 mm	90 mm	27,5 mm	29 mm	30 mm	B2
300x109K	37 <-> 41	28 mm	86 mm	24 mm	28 mm	30 mm	B1
320x54	70 <-> 84	30 mm	82 mm	22 mm	17 mm	25 mm	B1
320x84 (SSL)	50 <-> 53	45 mm	104 mm	45 mm	34 mm	38 mm	C2
320x86 (SSL)	48 <-> 52	36 mm	84 mm	48 mm	29,5 mm	39 mm	C2
320x90	52 <-> 56	32 mm	85 mm	48 mm	35 mm	40 mm	C2
320x100	38 <-> 54	28 mm	82 mm	32 mm	25 mm	42 mm	A2
320x106	39 <-> 43	32 mm	82 mm	27 mm	26 mm	32 mm	B2
350x52,5	70 <-> 92	40 mm	90 mm	24 mm	23 mm	28 mm	B1
350x54,5	80 <-> 86	40 mm	92 mm	23,5 mm	22,5 mm	-	B2
350x56	84	39 mm	90 mm	26 mm	18 mm	28 mm	B1
350x56R	84	39 mm	90 mm	26 mm	18 mm	28 mm	B2
350x75,5	74	40 mm	102 mm	23 mm	25 mm	33 mm	C2
350x109	41 <-> 44	39 mm	96 mm	22 mm	29 mm	34 mm	B1
370x107	39 <-> 41	38 mm	92 mm	26 mm	26 mm	32 mm	B2
400x72,5N	70 <-> 80	39 mm	96 mm	27 mm	26 mm	32 mm	B1
400x72,5W	68 <-> 92	50 mm	105 mm	28 mm	25 mm	35 mm	B1
400x72,5K	68 <-> 76	38 mm	96 mm	30 mm	27 mm	32 mm	B2
400x72,5R	74	50 mm	100 mm	29 mm	24 mm	35 mm	B2
400x72,5Y	72 <-> 74	28 mm	86 mm	30 mm	24,5 mm	-	C2
400x75,5	74	40 mm	102 mm	23 mm	23 mm	33 mm	C2
400x107	46	38 mm	92 mm	29 mm	28 mm	33 mm	C2
400x142K	36 <-> 37	30 mm	90 mm	32 mm	28 mm	44 mm	C2
400x144	36 <-> 41	42 mm	100 mm	27 mm	20 mm	36 mm	B1
420x100	50 <-> 58	50 mm	98 mm	51 mm	36 mm	44 mm	A2
450x71	76 <-> 88	43 mm	118 mm	25 mm	20 mm	40 mm	B1
450x73,5	76 <-> 84	42 mm	120 mm	30 mm	32 mm	-	B1
450x76	80 <-> 84	48 mm	118 mm	30 mm	30 mm	38 mm	B1
450x81N	72 <-> 80	40 mm	116 mm	26 mm	23 mm	40 mm	B1
450x81W	72 <-> 78	58 mm	142 mm	30 mm	30 mm	42 mm	B1
450x83,5K	72 <-> 74	40 mm	116 mm	26 mm	28 mm	40 mm	B1
450x83,5Y (Offset)	74	42 mm	112 mm	23 mm	27 mm	-	B2
450x84 (SSL)	53 <-> 56	45 mm	100 mm	47 mm	33 mm	40 mm	C2
450x90	58 <-> 76	40 mm	90 mm	39 mm	33 mm	36 mm	A2
450x100 (SSL)	48 <-> 65	50 mm	104 mm	47 mm	44 mm	45 mm	C2
450x163	38	39 mm	120 mm	29 mm	30 mm	44 mm	B2
500x90	76 <-> 82	46 mm	100 mm	52 mm	35 mm	43 mm	A2
500x92	72 <-> 84	48 mm	130 mm	28 mm	28 mm	43 mm	B1
600x100	76 <-> 80	48 mm	113 mm	60 mm	49 mm	-	A2
700x100	80 <-> 98	48 mm	125 mm	75 mm	58 mm	-	A2
750x150	66 mm	62 mm	176 mm	94 mm	68 mm	-	A2

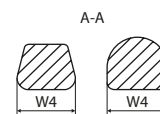
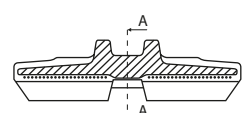
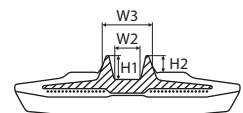
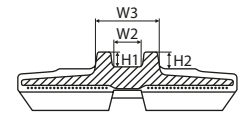



RUBBER PADS

RUBBER PADS

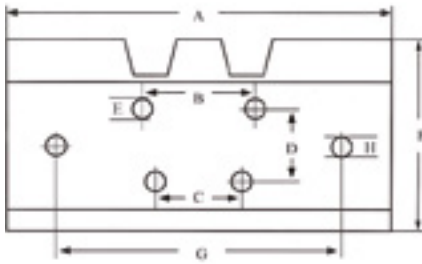

Single grouser plate size*

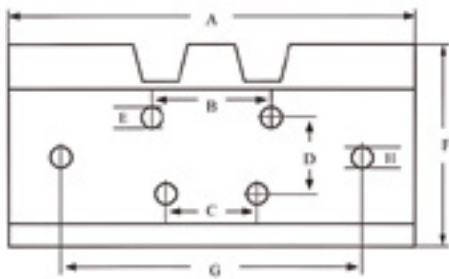

Double grouser plate size*

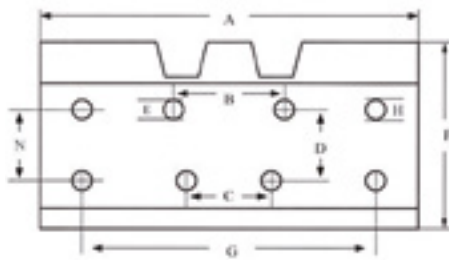

Triple grouser plate size*

* Choose your specific execution. Tick where necessary.

Machine type:

Model:

Number of links:

A:

F:

K:

B:

G:

L:

C:

H:

M:

D:

I:

N:

E:

J:

O:

TYRES, RIMS & ACCESSORIES

For all our latest catalogue updates and company info: www.tvh.com

TVH Worldwide

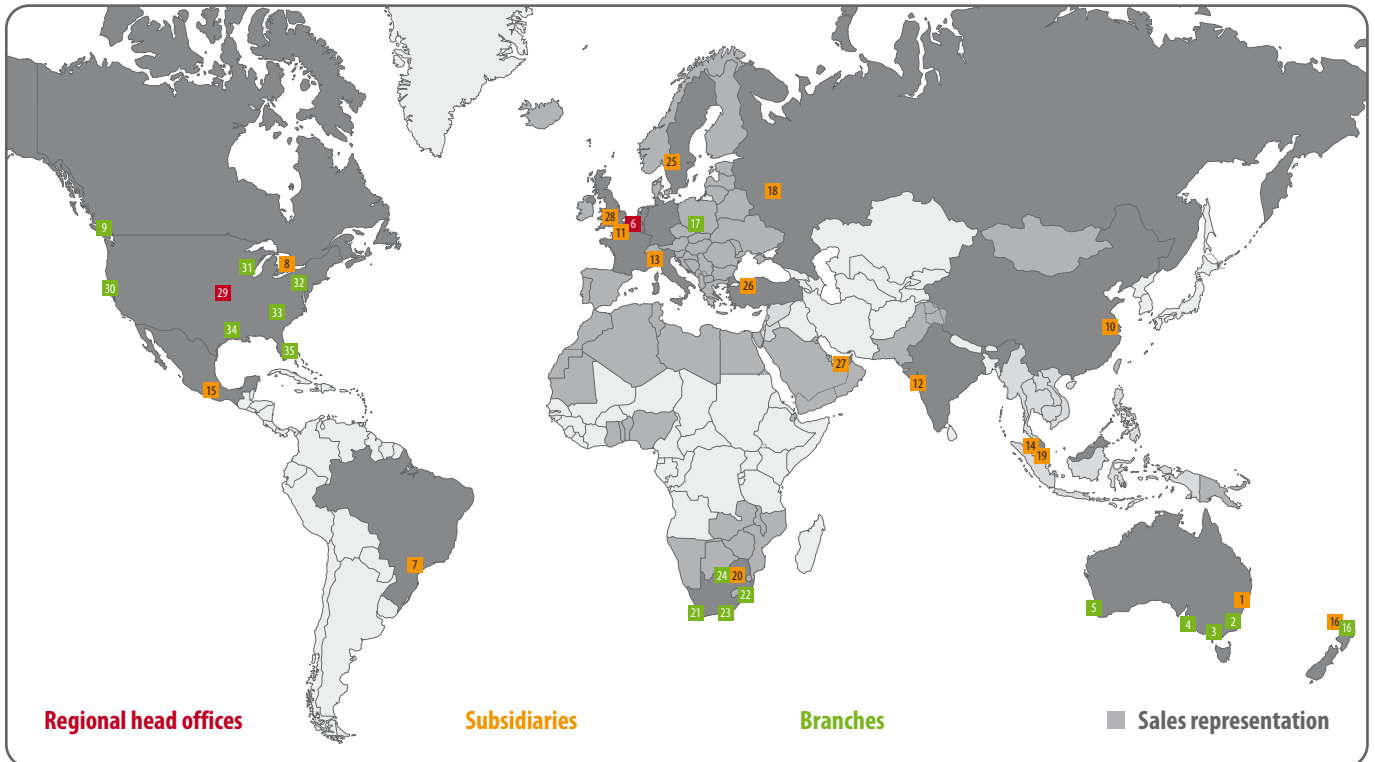

AUSTRALIA

- 01 TVH AUSTRALASIA PTY LTD (Queensland)
Richlands (Brisbane)
- 02 TVH AUSTRALASIA PTY LTD (New South Wales)
Wetherill Park (Sydney)
- 03 TVH AUSTRALASIA PTY LTD (Victoria)
- Dandenong South (Melbourne South)
- Sunshine (Melbourne West)
- 04 TVH AUSTRALASIA PTY LTD (South Australia)
Wingfield (Adelaide)
- 05 TVH AUSTRALASIA PTY LTD (West Australia)
Welshpool (Perth)



BELGIUM

- 06 THERMOTÉ & VANHALST NV
Waregem
- 06 CC HEFTRUCKS BVBA
Nieuwerkerken (Aalst)
- 06 HAVELANGE SA
Vilvoorde (Brussel)
- 06 TVH PARTS NV
Waregem



BRASIL

- 07 TVH DINAMICA PEÇAS LTDA
- Vinhedo
- São Paulo



CANADA

- 08 TVH CANADA LTD (Ontario)
Mississauga (Toronto)
- 09 TVH CANADA LTD (British Columbia)
Port Coquitlam (Vancouver)



CHINA

- 10 TVH TRADING (SHANGHAI) CO, LTD
Shanghai



FRANCE

- 11 TVH FRANCE SASU
Wattrelos



INDIA

- 12 TVH INDIA PTE LTD
Pune



ITALY

- 13 TVH ITALIA SRL
- Marano Ticino (Novara)
- Torino
- 13 CAM SRL
Marano Ticino (Novara)



MALAYSIA

- 14 TVH MALAYSIA SDN BHD
- Shah Alam (Kuala Lumpur)
- Johor Bahru
- Penang



MEXICO

- 15 TVH MEXICO, S DE RL DE CV
Cuautitlán Izcalli (Mexico City)



NEW ZEALAND

- 16 TVH NEW ZEALAND LTD
- East Tamaki (Auckland)
- Hamilton



POLAND

- 17 TVH POLSKA
Tychy



RUSSIA

- 18 TVH RUS LLC
Dubrovka (Moscow)



SINGAPORE

- 19 TVH SINGAPORE PTE LTD
Jurong (Singapore)



SOUTH AFRICA

- 20 TVH PARTS SOUTH AFRICA LTD
Isando (Johannesburg)
- 21 TVH PARTS SOUTH AFRICA LTD
Kraaifontein (Cape Town)
- 22 TVH PARTS SOUTH AFRICA LTD
Pinetown (Durban)
- 23 TVH PARTS SOUTH AFRICA LTD
Korsten (Port Elizabeth)
- 24 TVH PARTS SOUTH AFRICA LTD
Lichtenburg



SWEDEN

- 25 TVH NORDIC AB
Ed



TURKEY

- 26 TVH YEDEK PARÇA TICARET AŞ
- Başakşehir (Istanbul - European)
- Tuzla (Istanbul - Asian)



UNITED ARAB EMIRATES

- 27 TVH MIDDLE EAST FZE
Sharjah



UNITED KINGDOM

- 28 TVH UK LTD
Coventry



USA

- 29 TVH PARTS CO (Kansas)
Olathe
- 30 TVH PARTS CO (California)
Mira Loma
- 31 TVH PARTS CO (Illinois)
Grayslake
- 32 TVH PARTS CO (Pennsylvania)
Harrisburg
- 33 TVH PARTS CO (South Carolina)
Duncan
- 34 TVH PARTS CO (Louisiana)
Shreveport
- 35 TVH PARTS CO (Florida)
Miami
- 29 SUPERIOR SIGNALS, INC (Kansas)
Olathe

SALES REPRESENTATION IN THE FOLLOWING COUNTRIES:

Albania, Algeria, Austria, Bahrain, Belarus, Benin, Bosnia, Botswana, Bulgaria, Canary Islands, Croatia, Cyprus, Czech Republic, Denmark, Djibouti, Egypt, Estonia, Finland, Germany, Ghana, Greece, Hong Kong, Hungary, Iceland, Ireland, Kosovo, Kuwait, Latvia, Libya, Lithuania, Luxembourg, Macedonia, Malta, Morocco, Mozambique, Mauritania, Moldova Republic, Montenegro, Namibia, Netherlands, Nigeria, Norway, Oman, Pakistan, Portugal, Qatar, Romania, Saudi Arabia, Serbia, Slovakia, Slovenia, Spain, Switzerland, Taiwan, Togo, Tunisia, Ukraine, Yemen, Zambia, Zimbabwe.

Quality parts cheaper



WE SPEAK YOUR
LANGUAGE
info@tvh.com

- More than 100 000 m² of warehousing
- Computer-controlled stock management
- More than 600 000 stock items
- More than 21 000 000 known references
- Technically skilled employees
- Same-day shipment, next-day delivery
- Webshop and online support
- One-stop shop



FOLLOW US



PARTS & ACCESSORIES



PARTS MOVIE